

# Architectural Products Pricing Guide

## Table of Contents

General Information.....	GI
Section A - Entrances.....	A
Entrances.....	A1
Adds, Substitutions and Modifications.....	A2
Loose Hardware.....	A3
Section B - Storefronts.....	B
FL200 Storefront System.....	B1
FL300 Storefront System.....	B2
FL300T Thermal Storefront System.....	B3
FS400T Thermal Storefront System.....	B4
Angles, Channels, Flat Bars, & Tubes.....	B5
FL100 Removable Office Partition.....	B6
FL600 Storefront System.....	B7
FL600T Thermal Storefront System.....	B8
FL600UT Thermal Storefront System.....	B9
Section C - Curtain Walls.....	C
PW251 Curtain Wall System.....	C1
Section D - Impact-Resistant Entrances.....	D
Impact Doors and Frames.....	D1
Adds, Substitutions and Modifications.....	D2
Section E - Impact-Resistant Storefronts.....	E
FL500 Impact-Resistant Storefront System.....	E1
FL550 Impact-Resistant Storefront System.....	E2
FL550T Thermal Impact-Resistant Storefront System.....	E3
Section F - Impact-Resistant Curtain Walls.....	F
PW256 Impact-Resistant Curtain Wall.....	F1
PW257 Impact-Resistant Curtain Wall.....	F2

Page Left Intentionally Blank

## Table of Contents

	<i>Page</i>
Company Profile .....	1
Architectural Finishes .....	2-4
Warranties .....	5-11
Terms and Conditions .....	12-13

Page Left Intentionally Blank



## Coral Industries, Inc.



### History

Coral Industries, Inc. was established in 1976 as a manufacturer of quality bath enclosures. Our past growth can be contributed to the result of customer's success utilizing the many advantages Coral Industries offer: quality, service, innovative design and dependability. At Coral's 325,000 square feet manufacturing facility located in Tuscaloosa, Alabama, in-house capabilities include injection molding of plastic parts, soft and rigid vinyl extrusions, powder coat painted finishing, and complete fabrication of aluminum profiles and glass products, thus giving Coral Industries greater flexibility and control of the entire production process.

Over the years, Coral Industries has expanded by organizing additional divisions and products. **Central Alabama Transport (CAT)** was founded in 1977 and has proven to be a valuable addition to Coral Industries. CAT is a dedicated fleet of trucks which allows for our products to be delivered on a timely basis to distribution centers and businesses across the United States. **Coral Glass Division**, established in 1989, offers a full range of custom fabricated glass, ranging from 1/8" to 1". Coral Glass Division has an assortment of computer operated cutting, fabrication, and tempering machinery that allows for the fabrication of glass to exacting tolerances.

### Coral Architectural Products

In keeping with Coral Industries tradition of growth, **Coral Architectural Products (CAP)** was established in January 2005. CAP offers a full line of architectural aluminum entrance doors, storefronts, curtain walls, window walls and protective glazing products. To ensure structural integrity and performance requirements for today's demanding projects; all of our architectural products are tested to current AAMA and / or ASTM performance standards for structural, air and water infiltration at certified independent test laboratories. We have also designed and tested products that meet the stringent requirements of both High Velocity Hurricane Impact Zones and Blast Mitigation. Comprehensive architectural details, installation instructions and test reports are available for each system.

### The Product Line

CAP has combined the experience of its management team with over 35 years of designing, testing and marketing in the industry in order to develop **its industry leading** aluminum systems. Each system is designed and tested for simplicity, versatility, maximum performance and ease of installation.

### Mission Statement

Coral Industries, Inc. is dedicated to the continuous improvement of the quality of our products, processes and services in order to exceed our customer's expectations.

Coral Architectural Products offers a variety of architectural finishes satisfying the increased demands of the commercial construction industry in terms of finish types and performance, while protecting the environment. Standard finishes include, but are not limited to the following types: anodized finishes, factory applied powder coat and special baked-on liquid painted finishes. Consult with your local Coral sales representative or Coral’s national architectural representative at 1-800-772-7737 for additional surface treatments and options.

## Anodized Finishes

Anodic, or anodized, finishes for architectural aluminum profiles are artificially enhanced by a natural process in which aluminum combines with oxygen to form a thin layer of aluminum oxide. The result is an extremely durable finish offering excellent resistance to weathering and corrosion.

<b>ANODIZING FINISH CLASSIFICATION / CODE IDENTIFICATION</b>				
Coral Number	Color	Aluminum Association Specification	Classification	Stock
<b>CLEAR ANODIZED FINISHES</b>				
#11	Clear	AA-M12-C22-A41	Architectural Class I (.7 mils minimum)	Yes
<b>COLOR ANODIZED FINISHES</b>				
#21	Dark Bronze	AA-M12-C22-A44	Architectural Class I (.7 mils minimum)	Yes

\* Contact us for lead time.

## Powder Coat Painted Finishes

Powder Coat Finishes are high-performance durable architectural finishes offering improved gloss retention and enhanced resistance to chalking and fading. Environmentally friendly, powder coat finishes are solvent-free and provide outstanding mechanical properties and abrasion resistance over solvent based paints. Coral Architectural Products powder coat finishes are available in two levels of performance listed below.

**NOTE:** Contact the Coral factory for information on custom colors and non-stock finishes.

### AAMA 2604

POWDER COAT CLASSIFICATION/CODE IDENTIFICATION				
Coral Number	Color	American Architectural Manufacturers Association (AAMA) Specification	Classification	Stock
<b>FINISHES</b>				
#81	Bone White	AAMA 2604	Polyester	Yes
#92	Light Blue	AAMA 2604	Polyester	Yes
#93	Hartford Green	AAMA 2604	Polyester	Yes
#94	Tan	AAMA 2604	Polyester	Yes
#95	Coal Black	AAMA 2604	Polyester	Yes
#96	Sandstone	AAMA 2604	Polyester	Yes
#97	Seawolf	AAMA 2604	Polyester	Yes
#98	Redwood	AAMA 2604	Polyester	Yes

### AAMA 2605

POWDER COAT CLASSIFICATION/CODE IDENTIFICATION				
Coral Number	Color	American Architectural Manufacturers Association (AAMA) Specification	Classification	Stock
<b>FINISHES</b>				
#91	Bone White	AAMA 2605	70% Fluoropolymer	Yes
#82	Light Blue	AAMA 2605	70% Fluoropolymer	Yes
#83	Hartford Green	AAMA 2605	70% Fluoropolymer	Yes
#84	Tan	AAMA 2605	70% Fluoropolymer	Yes
#85	Coal Black	AAMA 2605	70% Fluoropolymer	Yes
#86	Sandstone	AAMA 2605	70% Fluoropolymer	Yes
#87	Seawolf	AAMA 2605	70% Fluoropolymer	Yes
#88	Redwood	AAMA 2605	70% Fluoropolymer	Yes

**PAINTED FINISHES - SPECIFICATIONS**

**AAMA 2604** – Voluntary Specification, Performance Requirements and Test Procedures for High Performance Organic Coatings on Aluminum Extrusion and Panels. This specification will assist the architect, owner and contractor to specify and obtain factory-applied organic coatings that meet a five-year level of performance in terms of film integrity, weatherability and general appearance.

**AAMA 2605** – Voluntary Specification, Performance Requirements and Test Procedures for High Performance Organic Coatings on Aluminum Extrusion and Panels. This specification will assist the architect, owner and contractor to specify and obtain factory-applied organic coatings that meet a ten-year level of performance in terms of film integrity, weatherability and general appearance.

<b>Coral Number</b>	<b>AAMA 2604</b>	<b>AAMA 2605</b>
Coating Thickness	1.2 mils	1.2 mils
Pre-treatment	Multi-stage Cleaning with Chemical Conversion Coating	Multi-stage Cleaning with Chrome Phosphate Conversion Coating 40 mg./ft <sup>2</sup> min.
Abrasion Resistance	Falling Stand Test - 20L/mil	Falling Stand Test - 50L/mil
Chemical Resistance	Muriatic Acid/Mortar Resistance/Nitric Acid Flumes Test	Muriatic Acid/Mortar Resistnace/Nitric Acid Flumes Test
Color Retention	5 Year South Florida (Max. Δ E)	10 Year South Florida (Max. Δ E)
Gloss Retention	Minimum of 30% after 5 Years South Florida	Minimum of 50% after 5 Years South Florida
Corrosion Resistance	3000 Hour Salt Spray Test	4000 Hour Salt Spray Test
Chalking Resistance	No more than #8	No More than #8 (#6 for White Colors)
Film Adhesion	Dry Adhesion/Wet Adhesion Boiling Water Adhesion	Dry Adhesion/Wet Adhesion Boiling Water Adhesion

\* Contact the Coral factory for availability and lead times on non-stock finishes.

# Limited Product Warranty and Remedy

Customer: \_\_\_\_\_

Project: \_\_\_\_\_

Effective Date: \_\_\_\_\_

Architectural Firm: \_\_\_\_\_

The Seller warrants, for a period of two (2) years from the date of substantial completion of the project provided however that the Limited Warranty shall begin in no event later than six months from date of initial shipment, that the products manufactured by the Seller shall be free from defects in workmanship and materials, provided that such products have been installed and maintained in strict accordance with all applicable safety and building codes, any and all other applicable standards, and Seller's installation instructions. This warranty is limited to defects discovered or which should be discovered within two years from the date of initial shipment provided that the Seller receives written notification specifying any and all defects within that two-year period. Seller's obligations under this warranty are limited to the repair or replacement of any defective materials and/or the refund by the Seller of the original purchase price paid for the product. The Seller reserves the exclusive right to select one of these remedies. In no event will the Seller be liable for direct, indirect, special or consequential damages including but not limited to loss of profits or use.

SELLER MAKES NO WARRANTY OTHER THAN THAT SET FORTH HERE. ALL OTHER EXPRESS AND IMPLIED WARRANTIES ARE HEREBY EXPRESSLY DISCLAIMED, DENIED AND EXCLUDED. SELLER MAKES NO WARRANTY OF MERCHANTABILITY OR THAT THE GOODS ARE FIT FOR ANY PARTICULAR PURPOSE. SELLER MAKES NO REPRESENTATION AS TO THE PRODUCT'S FITNESS FOR ANY PARTICULAR PURPOSE.

Warranty of Outside Suppliers – Seller makes no warranty, and hereby disclaims any and all express warranties, including but not limited to any warranty of merchantability or fitness for a particular purpose, for any products supplied by Seller, which are manufactured by others. Any warranty of such products is limited to that provided by the manufacturer of those products. The Seller will not assume charges for freight or labor for items manufactured by others and supplied by Seller.

Coral Architectural Products

\_\_\_\_\_  
Representative

\_\_\_\_\_  
Customer Service Manager  
Title

\_\_\_\_\_  
To Be Advised  
Date

SAMPLE WARRANTIES

**Door Corner Construction**  
**Limited Lifetime Warranty**

Customer: \_\_\_\_\_

Project: \_\_\_\_\_

Effective Date: \_\_\_\_\_

Architectural Firm: \_\_\_\_\_

This Warranty is in addition to Coral Architectural Products (Seller) standard two (2) years limited warranty and is wholly and exclusively applicable to Seller's factory fabricated and assembled aluminum entrance door's dual moment corner construction.

The Seller warrants to its dealers, customers, and all subsequent purchasers and users that its dual moment corner construction assembly shall be free from defects in workmanship and materials for the normal and useful lifetime of the door.

This warranty is effective from the date of substantial completion of the project provided however that the Limited Warranty shall begin in no event later than 6 months from date of initial shipment from Seller's factory and applies only if Seller's doors have been installed and maintained in strict accordance with Seller's published recommended practices and installation instructions and only if Seller is notified in writing within sixty (60) days after such defects appear.

Seller's obligations under this warranty are limited to the repair or replacement of any defective door and/or the refund by the Seller of the original purchase price paid for the door and does not include the replacement of glazing in-fills, gaskets, hardware, doorframe or adjacent framing temporary enclosures, nor any installation charges, labor charges, delivery or freight charges. The Seller reserves the exclusive right to select one of these remedies.

Seller hereby disclaims all Liability for any door that has been subjected to abuse, alterations, modifications, neglect, misuse, abnormal use, accident, fire, war, flood, earthquakes, Acts of God or damage caused by parts not furnished by Seller.

**In no event will the Seller be liable for Direct, Indirect, Special or Consequential Damages including, but not limited to, Loss of Profits or Good Will, Loss of Use or Other Commercial Loss or Injury. Seller further hereby disclaims all liability for the installation of Seller's doors. Seller makes no other Representations or Warranties, Express or Implied, including but not limited to any Implied Warranty of Merchantability or Fitness for a Particular Purpose.**

Warranty claim may be filed by notifying Seller in writing within sixty (60) days of defect discovery at:

Warranty Claim Office  
 Coral Architectural Products  
 P.O. Box 40228  
 Tuscaloosa, AL 35404-0228

Coral Architectural Products

\_\_\_\_\_  
 Representative

\_\_\_\_\_  
 Customer Service Manager  
 Title

\_\_\_\_\_  
 To Be Advised  
 Date

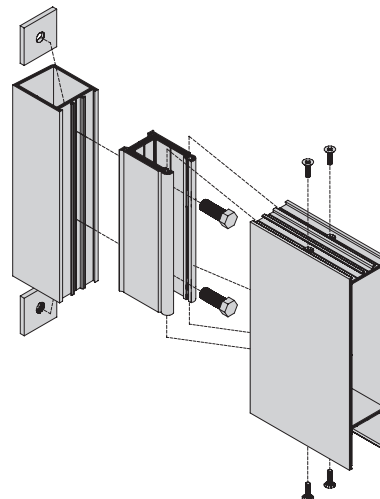

# Anodized Finish Limited Warranty

Customer: \_\_\_\_\_

Project: \_\_\_\_\_

Architectural Firm: \_\_\_\_\_

This warranty is in addition to the Coral Architectural Product's standard product warranty.

Coral Architectural Products ("CAP") warrants for a period of two (2) years, from the from the date of substantial completion of the project provided however that the Limited Warranty shall begin in no event later than six months from date of initial shipment, materials from CAP's plant, that all exposed aluminum on the above project furnished by CAP shall conform to the following:

The said aluminum will not develop excessive fading or excessive non-uniformity of color, and will not crack, peel, pit or corrode, all within the limits defined as follows:

"Excessive fading" means that all change in color during the period of this warranty shall not exceed 10% or a value of 4, whichever is greater, above or below the original limits of acceptable color range for the color specified, as color is expressed in units of color measures (DELTA E) derived by photoelectric trisulphur colorimetry as described by circular B-429 of the National Bureau of Standards.

"Excessive non-uniformity" means non-uniform fading during the period of the warranty to the extent that adjacent panels have a color difference greater than the original limits of acceptable color expressed in the same system of color measurement described above.

"Will not pit or corrode" means that there shall be no pitting or other type of corrosion discernible by the naked eye from a distance of 10 feet resulting from the natural elements in the atmosphere at the project site.

This Warranty applies only if such anodized material is installed in strict accordance with CAP's recommended practices and maintained in accordance with American Architectural Manufacturers Association (AAMA) Publication Number 609.1 "Voluntary Guide Specification for Cleaning and Maintenance of Architectural Anodized Aluminum". AAMA Publication No. 609.1 will be furnished upon request. This Warranty does not cover, and CAP hereby expressly disclaims, all liability for and with respect to any material which has been subject to abuse, alteration, modification, neglect, misuse, abnormal use, accident, fire, war, flood, earthquake or acts of God.

The sole and exclusive remedy with respect to this Warranty shall be repair or replacement of the defective material or repayment by CAP of the purchase price paid therefore. CAP reserves the right to select the remedy.

The foregoing is extended solely to the Customer and is granted IN LIEU OF ALL OTHER GUARANTEES AND WARRANTIES, EXPRESSED OR IMPLIED, INCLUDING, WITHOUT THE GENERALITY OF THE FOREGOING, ANY GUARANTEE OR WARRANTY OF MERCHANTABILITY OF FITNESS FOR A PARTICULAR PURPOSE.

Coral Architectural Products

\_\_\_\_\_  
Representative

\_\_\_\_\_  
Customer Service Manager  
Title  
February 2022

\_\_\_\_\_  
To Be Advised  
Date  
www.coralap.com



## SAMPLE WARRANTIES

# Painted Finish Limited Warranty

## D2000 Powder Coat Finish

Customer: \_\_\_\_\_

Project: \_\_\_\_\_

Date of Substantial Completion: \_\_\_\_\_

This conditional limited warranty is in addition to the Coral Architectural Product's conditional limited standard product warranty. Coral Architectural Products (CAP) warrants that during the warranty period there will be:

### Clause 1

- No visible checking\* or cracking\* of the **Interpon D2000™** powder coating.
- No chalking\* of the **Interpon D2000™** powder coating in excess of that represented by Number 8 rating based on ASTM D4214.
- No color change of the **Interpon D2000™** powder coating greater than 5 (five) CIE Lab AE units calculated in accordance with ASTM 2244 Section 6.3. Color change shall be measured on the exposed surface which has been cleaned of oil, grease, chalk and oxidized film or other contaminants. Corresponding values shall be measured on the original retained batch panel. (Panel stored in the dark at temperatures below 30° C).

### Clause 2

- Gloss Retention of the **Interpon D2000™** powder coating when applied to test panels will be greater than or equal to 30% after 5 years exposure in Florida (facing 45° South) in accordance with the requirements of AAMA 2604-02 Clause 7.9.1.4.2.
- Adhesion of the **Interpon D2000™** powder coating when initially applied to test panels and measured by reference to AAMA 2604-02 Clause 7.4.2 will show no removal of the film.

### Warranty Terms and Conditions

- The "Warranty Period" for the warranties in Clause 1 shall mean the period of fifteen (15) years, and for the warranty in Clause 2 shall mean five (5) years, commencing on the date of substantial completion of the project or six months from the date of the initial shipment, whichever is sooner?
- Color measurements (delta E) are measured at 10 degrees and on exposed coated surfaces that have been cleaned of all external deposits including chalk and compared to the original unexposed coated surface. For comparison purposes, CAP will maintain a standard paint panel and/or documentation indicating color, gloss and other properties. It is understood that fading may not be uniform if the coated surfaces are not equally exposed to the sun and weathering elements. Prior to the determination of a gloss value using an angle of incidence of 60 degrees following ASTM D523, the surface must be cleaned using a 1% aqueous solution of a wetting agent with a soft sponge under light pressure.
- This warranty extends only to parts exposed to normal atmospheric conditions in the United States.
- A systematic maintenance program must be instituted to clean the surface periodically so as to prevent accumulations of salt deposits and harmful pollutants.
- This Warranty applies only if such painted material is installed in strict accordance with CAP's recommended practices and maintained in accordance with American Architectural Manufacturers Association (AAMA) Publication Number 610.1 "Voluntary Guide Specification for Cleaning and Maintenance of Architectural Painted Aluminum". AAMA Publication No. 610.1 will be furnished upon request.
- Maintenance: The cleaning recommendations for **Interpon D2000™** is an integral part of the warranty given for gloss, color retention and chalking. The warranty requires that regular cleaning has to be performed periodically, at least once a year and twice a year for structures directly exposed to areas of high salt concentration, such as near a seashore.



# Painted Finish Limited Warranty

## D2000 Powder Coat Finish

The conditions are as follows:

- ◆ Clean water with slight amounts of mild alkaline detergents must be used.
- ◆ The cleaning effect maybe increased by rubbing with a soft, non-scratching cloth or cotton with modest pressure.
- ◆ The temperature of the parts to be cleaned must not exceed 80° F.
- ◆ For removal of grease and oily substances isopropyl alcohol may be used.
- ◆ The cleaning solution must not be allowed to react for more than one (1) hour.
- ◆ After cleaning the surfaces must be rinsed with clean, cold water.
- ◆ A proper maintenance record has to be kept and documented. This documentation must contain the following information:
  - ✓ Date
  - ✓ Name and address of performing party
  - ✓ Description of cleaning procedure and detergents used
  - ✓ Signature of person performing the cleaning procedure

This warranty does not extend to:

- a) Damage to the coating caused by moisture or other contamination during storage of the powder or substrate or application;
- b) Damage to the coating during handling, shipping, processing, installation, improper cleaning or maintenance, etc.;
- c) Damage caused by impact, external forces, abrasion, environmental pollution, acid rain, immersion in salt water, hail, abnormal weather conditions, exposure to excessive temperatures (in excess of 150 F), solvents or chemicals, tapes, sealants, acts of God or other abuse; or
- d) Damage due to other circumstances beyond CAP's control.

### Claim Procedure

In the event of a claim, claimant shall demonstrate that the failure of the product was due to a breach of this warranty and furnish proof of purchase of the defective CAP product. Claims must be made in writing within thirty days after the customer becomes aware of the failure or potential failure of the coating. CAP must be given an opportunity to inspect the substrate and coating that form the basis for the claim.

The sole and exclusive remedy with respect to this Warranty shall be repair or replacement of the defective material or repayment by CAP of the purchase price paid therefore. CAP reserves the right to select the remedy.

The foregoing is extended solely to the Customer and is granted IN LIEU OF ALL OTHER GUARANTEES AND WARRANTIES, EXPRESSED OR IMPLIED, INCLUDING, WITHOUT THE GENERALITY OF THE FOREGOING, ANY GUARANTEE OR WARRANTY OF MERCHANTABILITY OF FITNESS FOR A PARTICULAR PURPOSE.

Coral Architectural Products

\_\_\_\_\_  
Representative

\_\_\_\_\_  
Customer Service Manager  
Title

\_\_\_\_\_  
To Be Advised  
Date

## SAMPLE WARRANTIES

# Painted Finish Limited Warranty

## D3000 Powder Coat Finish

Customer: \_\_\_\_\_

Project: \_\_\_\_\_

Date of Substantial Completion: \_\_\_\_\_

This conditional limited warranty is in addition to the Coral Architectural Product's conditional limited standard product warranty. Coral Architectural Products (CAP) warrants that during the warranty period there will be:

### Clause 1

- No visible checking\* or cracking\* of the **Interpon D3000™** powder coating.
- No chalking\* of the **Interpon D3000™** powder coating in excess of that represented by Number 8 rating based on ASTM D4214.
- No color change of the **Interpon D3000™** powder coating greater than 5 (five) CIE Lab AE units calculated in accordance with ASTM 2244 Section 6.3. Color change shall be measured on the exposed surface which has been cleaned of oil, grease, chalk, and oxidized film or other contaminants, corresponding values shall be measured on the original retained batch panel. (Panel stored in the dark at temperatures below 30° C).0° C).

### Clause 2

- Gloss Retention of the **Interpon D3000™** powder coating when applied to test panels will be greater than or equal to 50% after ten (10) years exposure in Florida (facing 45° South) in accordance with the requirements of AAMA 2605-02 Clause 7.9.1.4.2.
- Adhesion of the **Interpon D3000™** powder coating when initially applied to test panels and measured by reference to AAMA 2605-02 Clause 7.4.2 will show no removal of the film.

### Warranty Terms and Conditions

- The "Warranty Period" for the warranties in Clause 1 shall mean the period of twenty (20) years, and for the warranty in Clause 2 shall mean ten (10) years, commencing on the date of substantial completion of the project or six months from the date of the initial shipment, whichever is sooner?
- Color measurements (delta E) are measured at 10 degrees and on exposed coated surfaces that have been cleaned of all external deposits including chalk and compared to the original unexposed coated surface. For comparison purposes, CAP will maintain a standard paint panel and/or documentation indicating color, gloss and other properties. It is understood that fading may not be uniform if the coated surfaces are not equally exposed to the sun and weathering elements. Prior to the determination of a gloss value using an angle of incidence of 60 degrees following ASTM D523, the surface must be cleaned using a 1% aqueous solution of a wetting agent with a soft sponge under light pressure.
- This warranty extends only to parts exposed to normal atmospheric conditions in the United States.
- A systematic maintenance program must be instituted to clean the surface periodically so as to prevent accumulations of salt deposits and harmful pollutants.
- This Warranty applies only if such painted material is installed in strict accordance with CAP's recommended practices and maintained in accordance with American Architectural Manufacturers Association (AAMA) Publication Number 610.1 "Voluntary Guide Specification for Cleaning and Maintenance of Architectural Painted Aluminum". AAMA Publication No. 610.1 will be furnished upon request.
- Maintenance: The cleaning recommendations for **Interpon D3000™** is an integral part of the warranty given for gloss, color retention, and chalking. The warranty requires that regular cleaning has to be performed periodically, at least once a year and twice a year for structures directly exposed to areas of high salt concentration, such as near a seashore.

# Painted Finish Limited Warranty

## D3000 Powder Coat Finish

The conditions are as follows:

- ◆ Clean water with slight amounts of mild alkaline detergents must be used.
- ◆ The cleaning effect maybe increased by rubbing with a soft, non-scratching cloth or cotton with modest pressure.
- ◆ The temperature of the parts to be cleaned must not exceed 80° F.
- ◆ For removal of grease and oily substances isopropyl alcohol may be used.
- ◆ The cleaning solution must not be allowed to react for more than one (1) hour.
- ◆ After cleaning the surfaces must be rinsed with clean, cold water.
- ◆ A proper maintenance record has to be kept and documented. This documentation must contain the following information:
  - ✓ Date
  - ✓ Name and address of performing party
  - ✓ Description of cleaning procedure and detergents used
  - ✓ Signature of person performing the cleaning procedure

This warranty does not extend to:

- a) Damage to the coating caused by moisture or other contamination during storage of the powder or substrate or application;
- b) Damage to the coating during handling, shipping, processing, installation, improper cleaning or maintenance, etc.;
- c) Damage caused by impact, external forces, abrasion, environmental pollution, acid rain, immersion in salt water, hail, abnormal weather conditions, exposure to excessive temperatures (in excess of 150 F), solvents or chemicals, tapes, sealants, acts of God or other abuse; or
- d) Damage due to other circumstances beyond CAP's control.

### Claim Procedure

In the event of a claim, claimant shall demonstrate that the failure of the product was due to a breach of this warranty and furnish proof of purchase of the defective CAP product. Claims must be made in writing within thirty (30) days after the customer becomes aware of the failure or potential failure of the coating. CAP must be given an opportunity to inspect the substrate and coating that form the basis for the claim.

The sole and exclusive remedy with respect to this Warranty shall be repair or replacement of the defective material or repayment by CAP of the purchase price paid therefore. CAP reserves the right to select the remedy.

The foregoing is extended solely to the Customer and is granted IN LIEU OF ALL OTHER GUARANTEES AND WARRANTIES, EXPRESSED OR IMPLIED, INCLUDING, WITHOUT THE GENERALITY OF THE FOREGOING, ANY GUARANTEE OR WARRANTY OF MERCHANTABILITY OF FITNESS FOR A PARTICULAR PURPOSE.

Coral Architectural Products

\_\_\_\_\_  
Representative

\_\_\_\_\_  
Customer Service Manager  
Title

\_\_\_\_\_  
To Be Advised  
Date

Per the American Architectural Manufacturers Association, (AAMA) Aluminum Storefront and Entrance Manual, section regarding Consideration of the Elements:

“Air and water infiltration may be difficult to control under severe conditions. Specific clearances are necessary between a swinging type door and frame, to prevent a metal-to-metal contact. Weathering will normally take care of these conditions and an applied sweep will normally close up to a 5mm (.19) clearance between a bottom rail of the door and the threshold or finished floor.”

Coral Architectural Products does not test our entrance door products for water infiltration and make no claim that they are impermeable to water. The Aluminum Storefront and Entrance industry does not typically perform this testing. Coral’s door products are a great addition to your entrances, will provide years of exceptional service, and will resist most weather conditions, especially when coupled with building design considerations for water control.

---

### TERMS AND CONDITIONS OF SALE

- 1. Acceptance of Orders and Minimum Charge** – All orders are subject to credit approval and acceptance by the Seller. Minimum charge is \$50.00 net per order.
- 2. Acceptance of Terms** – Should the Buyer object to any of the Seller's terms and conditions, the Buyer must forward objections in writing to the Seller together with Buyer's purchase order or request for quotation. If a written objection is not received by the Seller, and accepted in writing by an officer of the Seller, the Buyer shall be deemed to have assented to all of the Seller's terms and conditions. None of the Buyer's terms and conditions are acceptable to the Seller unless the Buyer's terms and conditions are agreed to in writing by an officer of the Seller prior to the acceptance of the Buyer's order or as a part of the Seller's job quotation. Otherwise, the sale is conditioned upon the Buyer's acceptance of the Seller's terms and conditions and any orders accepted by the Seller are accepted and conditioned upon the Seller's terms and conditions as the only terms and conditions applicable to the sale. None of the terms and conditions in the Buyer's purchase order, acknowledgement form, confirmation or other document issued by the Buyer which conflict with the Seller's terms and conditions, or increase the Seller's obligations, shall be binding on the Seller unless specifically identified and accepted in writing by an officer of the Seller.
- 3. Claims** – Claims by the Buyer for defective materials or workmanship must be submitted in writing to the seller within ten (10) working days after receipt of shipment. Unauthorized back charges, claims, deducts, or withheld payments will not be accepted. The Seller shall have the exclusive right to select the final remedy for defective material, which will be expressly limited to the repair, replacement, or repayment of the original purchase price paid by the Buyer upon return of the material to the Seller. Seller shall not be liable for any penal, incidental or consequential damages.
- 4. Back Orders** – Back orders or any portion of the order omitted from the original shipment will be invoiced at the same price, terms, and conditions as if it were part of the original shipment.
- 5. Cancellations and Returns** – Cancellation and return of custom orders will result in substantial cost to the Buyer. The Seller will issue a credit for the scrap value only on these orders. Return or cancellation of standing stock items may be made provided the Seller has issued prior written authorization. Returns must have an Return Material Authorization number (RMA) assigned by Seller. Any standard stock material received in a resalable condition will be credited based on a 20% restocking charge of the Seller's sale price with a minimum charge of \$100.00 net. The customer must pay all freight charges on returned goods. No material will be accepted for return beyond 60 days from the original shipment date.
- 6. Change Orders** – Orders shall not be amended, modified or rescinded except by written change order signed by an authorized official of each party expressly referring to a specific change and order. All change orders affecting completed or in-process work on the Buyer's original order will be subject to a change order charge to be determined by the Seller.
- 7. Clerical Errors** – Clerical and arithmetical errors are subject to correction by the Seller.
- 8. Credit Extension** – No credit will be extended by the Seller unless the Buyer's credit has been approved and is satisfactory at the time of shipment. The Seller reserves the right, at any time, to revoke credit extended should Buyer fail to pay for goods when due or for any other reason deemed sufficient by the Seller.
- 9. Delays in Shipping** – Seller will use its best effort to ship goods ordered by Buyer on scheduled shipping dates. Seller shall not be liable to Buyer for damages for late shipments nor shall the validity of the agreement be affected by Force Majeure; meaning acts of God, fire, war, civil commotion, strikes, shortages of labor or materials, casualties, or any other conditions beyond the control of Seller. If a Buyer elects to delay shipment of goods later than the original shipping date, the Seller may invoice Buyer on original shipping date and Buyer agrees to pay as if the goods were timely shipped. Buyer also agrees to pay reasonable storage charges in the event of such delayed shipping.

# General Information

## Terms and Conditions



- 10. Design Responsibility** – The Seller’s continuing endeavor to provide the best in product technology requires Seller to retain the right to change or modify its products without prior notice. The product illustrations used in the Seller’s brochures and catalogs are for identification only and may not represent the size or proportions by comparisons. If any material shall be manufactured or sold by the Seller to meet the Buyer’s specifications or requirements and is not part of the Seller’s standard line offered to the general trade in the usual course of the Seller’s business, then the Buyer agrees to indemnify, defend, protect and hold harmless the Seller against all claims, damages and lawsuits for actual or alleged infringement of any U.S. or foreign patent.
- 11. Entire Contract** – These terms and conditions reflect the entire agreement between the Seller and Buyer and supersedes all prior negotiations and agreements, oral or written. The agreements reflected herein may not be modified or altered except by a written agreement signed by officers of both the Seller and Buyer.
- 12. Indemnification** – Buyer waives and agrees that in the event of any breach of this agreement by Seller. Seller shall not be responsible to Buyer or any third parties for any incidental or consequential damages suffered by Buyer or third parties other than the Seller’s exclusive right to select the final remedy which will be expressly limited to the repair, replacement or repayment of the original purchase price paid by the Buyer. In the event of a claim for consequential or incidental damages, Buyer agrees to indemnify and hold harmless the Seller from such claims and damages.
- 13. Jurisdiction and Governing Law** – (Laws of State of Alabama) Any controversy or claims arising from or relating to this contract shall be settled by arbitration in accordance with the Commercial Arbitration rules of the American Arbitration Association, and judgment upon the award rendered may be entered in court having jurisdiction thereof.
- 14. Late Payment** – Unless otherwise expressly provided, all payments are Net 30 Days after date of invoice. Seller may at any time require payment in advance or satisfactory security that invoices will be paid when due, if in the Seller’s judgment the same becomes necessary. All orders are subject to credit approval and to acceptance by Seller. If payment is not made when due, 1 % per month interest will be charged thereon from the due date until paid.
- 15. Limitation of Liability** – The Seller’s only liability for defective materials shall be limited to the Seller’s exclusive right to select the final remedy which will be expressly limited to the repair, replacement or repayment of the original purchase price by the Buyer. Repayment is to be made to the Buyer upon return of defective material to the Seller. Under no circumstances will any job site repairs or replacements be made or labor charges for same be accepted.

**Section A**  
**ENTRANCES**  
**Table of Contents**

Entrances..... A1  
Adds, Substitutions and Modifications..... A2  
Standard Loose Hardware..... A3

Page Left Intentionally Blank



Section A1  
 Table of Contents

**ENTRANCES**

**Doors and Frames**

Entrance Door Handing Information .....	1
Door Types and Descriptions.....	2
Entrance Door and Numbering Information.....	3
Push/Pull Hardware Options .....	4
Glass Sizes .....	5
Standard Hardware Locations .....	6-7
Offset Pivot Doors and Frames.....	8-11
Offset Pivot CVR Panic Doors and Frames .....	12-15
Offset Pivot Offset Arm Assembly Doors and Frames .....	16-19
Offset Pivot CVR Panic Offset Arm Assembly Doors and Frames.....	20-23
Butt Hinge Door and Frames .....	24-27
Butt Hinge CVR Panic Doors and Frames.....	28-31
Butt Hinge Offset Arm Assembly Doors and Frames .....	32-35
Butt Hinge CVR Panic Offset Arm Assembly Doors and Frames .....	36-39
Center Pivot Doors and Frames.....	40-43
Showroom Doors and Frames .....	44-47

Page Left Intentionally Blank

Commercial aluminum storefront and entrance doors are primarily designed for:

1. Exterior applications
2. To swing or open out
3. In the case of double acting doors, to swing in and out

Because of the design, and due to building codes and life safety laws prohibiting such, single acting doors may never swing inward when installed in an exterior application. However, when used for interior applications (Example: Interior office doors), unless prevented by a particular building code, doors may swing in, or open to the interior.

**HAND:** All single acting swing doors are handed. The hand of a single acting swing door indicates which side it is hinged on (or will swing from) and the direction in which it is to swing. When determining the hand of a door, it should be viewed from the exterior. It will either be hinged on its left side, or hinged on its right side, and (for exterior applications) will always swing out. For interior applications, it may swing in.

The “hand” of a door is designated as follows.

For **Exterior applications** (as viewed from the exterior):

1. HL SO Hinge Left Swing Out = RH (Right Hand Door)
2. HR SO Hinge Right Swing Out = LH (Left Hand Door)

For **Interior applications** (as viewed from the exterior):

1. HL SO Hinge Left Swing Out = RH (Right Hand Door)
2. HR SI Hinge Right Swing In = RH (Right Hand Door)
3. HR SO Hinge Right Swing Out = LH (Left Hand Door)
4. HL SI Hinge Left Swing In = LH (Left Hand Door)

**SINGLE ACTING** commercial aluminum entrances are designed for exterior applications and to open or “swing” in an outward direction. To determine the “hand” of a single acting entrance, envision placing your back against the hinge side of the opening and extend whichever hand would be appropriate for the direction the door opens.

Only entrances used in interior applications are allowed to swing in an inward direction. The same method described above for determining the “hand” of the door applies

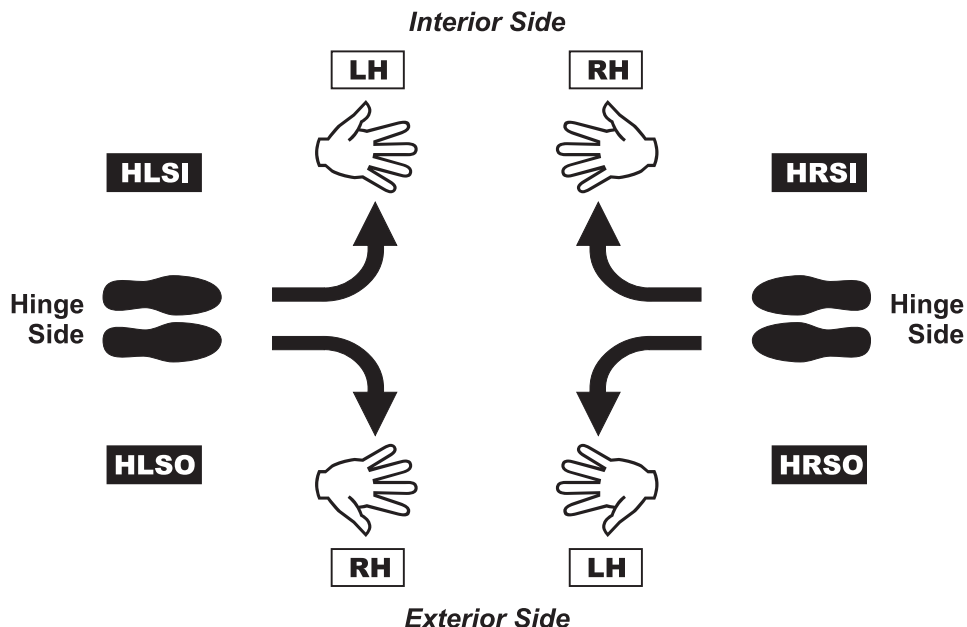

# Entrances

## Door Types & Descriptions

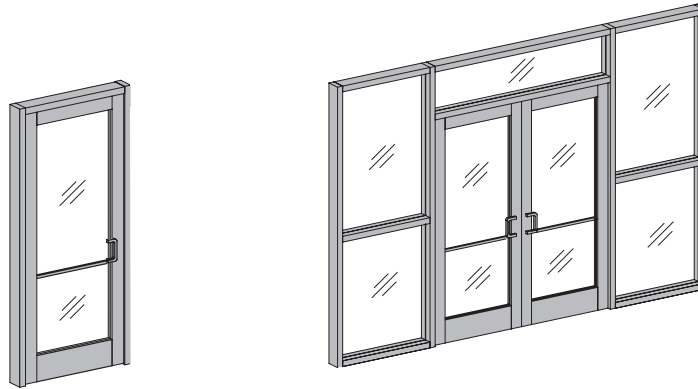

Aluminum Entrance Doors	VERTICAL STILE	TOP RAIL	BOTTOM RAIL	RECOMMENDED LIMITATIONS	TRAFFIC APPLICATION
Series 213 Narrow Stile	2 1/8"	2 1/4"	4"	3'-3" x 8'-0"	Normal
Series 380 Medium Stile	3 3/4"	4"	7 1/2"	3'-6" x 9'-0"	Moderate
Series 500 Wide Stile	5"	4"	7 1/2"	3'-6" x 9'-0"	Heavy

Note: Entrance doors exceeding 3'-6" in width or 7'-6" in height require an intermediate butt hinge or pivot.

### COMMON DOOR AND FRAME DESCRIPTIONS

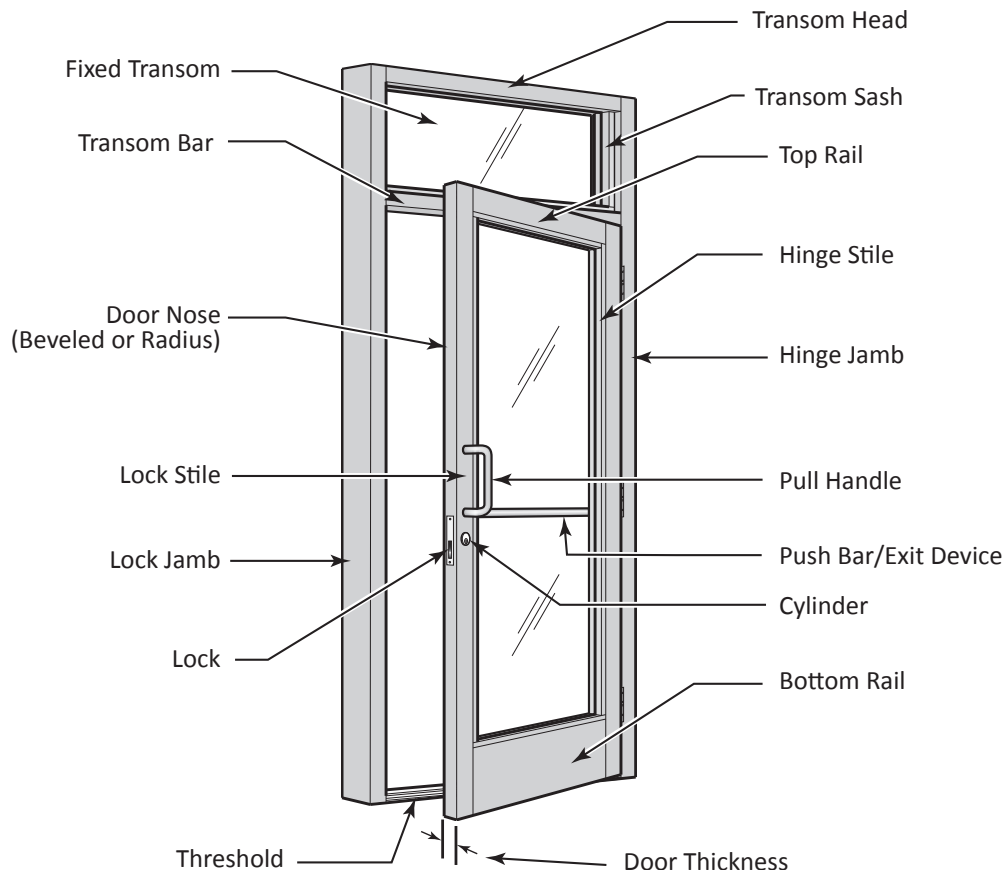

**DOOR  
PART NUMBER  
INFORMATION**

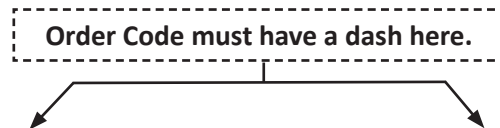

D.O.W. (Inches)	D.O.H. (Inches)	STILE WIDTH	SWING & HINGING	ADDED HARDWARE	FINISH CODE
36 <i>(Specify)</i>	84 <i>(Specify)</i>	<i>(Select)</i>	C <i>(Select)</i>	O <i>(Select)</i>	11 <i>(Select)</i>
DOOR OPENING WIDTH	DOOR OPENING HEIGHT	NARROW = LEAVE BLANK MEDIUM = MS WIDE = WS	FROM CHART 1	P = CVR PANIC O = OFFSET ARM	#11 CLEAR #21 BRONZE # 81 White PC #99 2604 PC #89 2605 PC

**For example: (3684-CYO-11)**  
The above example depicts a 3684 Right Hand Offset Pivot Door with **D108** Bottom Rail for Offset Arm in Clear Anodized Finish

**NOTE:** After "Swing and Hinging" Code, Add "Y" for **D108** or "Z" for **D109** Bottom Rail Substitutions.  
(**D108** is standard on Series 380 and 500 doors)

**FRAME  
PART NUMBER  
INFORMATION**

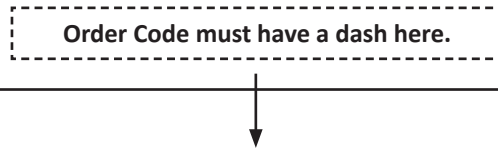

D.O.W. (INCHES)	D.O.H. (Inches)	SWING & HINGING	ADDED HARDWARE	FRAME TYPE	FINISH CODE
36 <i>(Specify)</i>	84 <i>(Specify)</i>	C <i>(Select)</i>	O <i>(Select)</i>	F2 <i>(Select)</i>	11 <i>(Select)</i>
DOOR OPENING WIDTH	DOOR OPENING HEIGHT	FROM CHART 1	P= PANIC O= OFFSET ARM	F2= FRAME FT2= FRAME W/TRANSOM F3= FRAME FT3= FRAME W/TRANSOM	#11 CLEAR #21 BRONZE # 81 White PC #99 2604 PC #89 2605 PC

**For example: (3684-C-F2-11)**  
The above example depicts a 3684 Right Hand Offset Pivot Frame in Clear Anodized Finish

**F2** = 1 3/4" x 4 1/2" Frame  
**FT2** = 1 3/4" x 4 1/2" Frame w/ Transom  
**F3** = 2" x 4 1/2" Frame  
**FT3** = 2" x 4 1/2" Frame w/ Transom

**CHART 1**

	BUTT HINGE	OFFSET PIVOT	CENTER PIVOT
RIGHT HAND SINGLE	A	C	G
LEFT HAND SINGLE	B	D	H
PAIR OF DOORS	J	K	M

# Entrances

## Push/Pull Hardware

---

### Traditional Hardware

Standard on all Doors

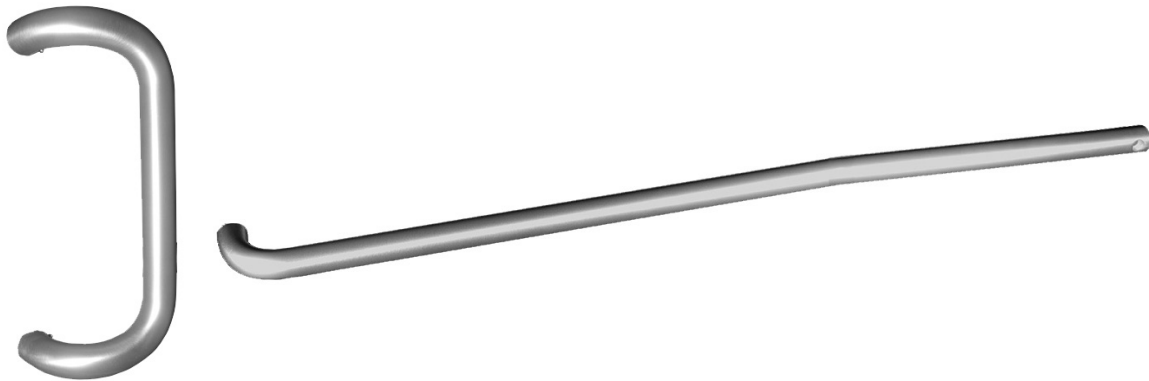

Clear Push/Pull is standard on clear and powder coated doors.  
Champagne Push/Pull is standard on bronze doors.

### GLASS SIZES FOR SERIES 213, SERIES 380 AND SERIES 500 STANDARD ENTRANCE DOORS

DOOR OPENING	STILE TYPE	TOP RAIL (PART NUMBER)	TOP RAIL HEIGHT	BOTTOM RAIL (PART NUMBER)	BOTTOM RAIL HEIGHT	STILE WIDTH	GLASS SIZE
3684 or 7284	NS213	D101	2 ¼"	D102	4"	2 ½"	31 ½" x 76 ½"
3684 or 7284	NS213	D102	4"	D102	4"	2 ½"	31 ½" x 74 ¾"
3684 or 7284	NS213	D101	2 ¼"	D108	7 ½"	2 ½"	31 ½" x 73"
3684 or 7284	NS213	D101	2 ¼"	D109	9 ½"	2 ½"	31 ½" x 71"
3684 or 7284	MS380	D102	4"	D108	7 ½"	3 ¾"	27 ⅞" x 71 ¼"
3684 or 7284	WS500	D102	4"	D108	7 ½"	5"	25 ⅜" x 71 ¼"
3684 or 7284	MS380	D102	4"	D109	9 ½"	3 ¾"	27 ⅞" x 69 ¼"
3684 or 7284	WS500	D102	4"	D109	9 ½"	5"	25 ⅜" x 69 ¼"
4284 or 8484	NS213	D101	2 ¼"	D102	4"	2 ½"	37 ½" x 76 ½"
4284 or 8484	NS213	D102	4"	D102	4"	2 ½"	37 ½" x 74 ¾"
4284 or 8484	NS213	D101	2 ¼"	D108	7 ½"	2 ½"	37 ½" x 73"
4284 or 8484	NS213	D101	2 ¼"	D109	9 ½"	2 ½"	37 ½" x 71"
4284 or 8484	MS380	D102	4"	D108	7 ½"	3 ¾"	33 ⅞" x 71 ¼"
4284 or 8484	WS500	D102	4"	D108	7 ½"	5"	31 ⅜" x 71 ¼"
4284 or 8484	MS380	D102	4"	D109	9 ½"	3 ¾"	33 ⅞" x 69 ¼"
4284 or 8484	WS500	D102	4"	D109	9 ½"	5"	31 ⅜" x 69 ¼"

### GLASS WIDTH FORMULAS (inches)

SINGLE or PAIR	FORMULA
Single	NS213= D.O.W. minus 4 ⅞"
Pair	NS213= D.O.W. divided by 2 minus 4 ⅞"
Single	MS380= D.O.W. minus 8 ⅞"
Pair	MS380= D.O.W. divided by 2 minus 8 ⅞"
Single	WS500= D.O.W. minus 10 ⅞"
Pair	WS500= D.O.W. divided by 2 minus 10 ⅞"

Note: D.O.W. = Door Opening Width

### GLASS HEIGHT FORMULAS (inches)

STEP #			EXAMPLE	
1)	D.O.H. Door Height dimension specified is:		84"	
2)	Deduct clearance at Door Frame Header:	- ⅛"	(- ⅛")	N/A
3)	Deduct Top Rail dimension:	Select	(-2 ¼")	Part # = (D101)
4)	Deduct Bottom Rail dimension:	Select	(-4")	Part # = (D102)
5)	Deduct clearance between Bottom of Door and Top of Threshold:	- ⅜"	(- ⅜")	N/A
6)	Deduct for height of Threshold:	- ½"	(- ½")	Part # = (TH4)
7)	Deduct for Glass Bite and Setting Block:	- ⅜"	(- ⅜")	N/A
Note: D.O.H. = Door Opening Height		Glass Height	(76 ½")	

# Entrances

## Hardware Locations

### Offset Pivots

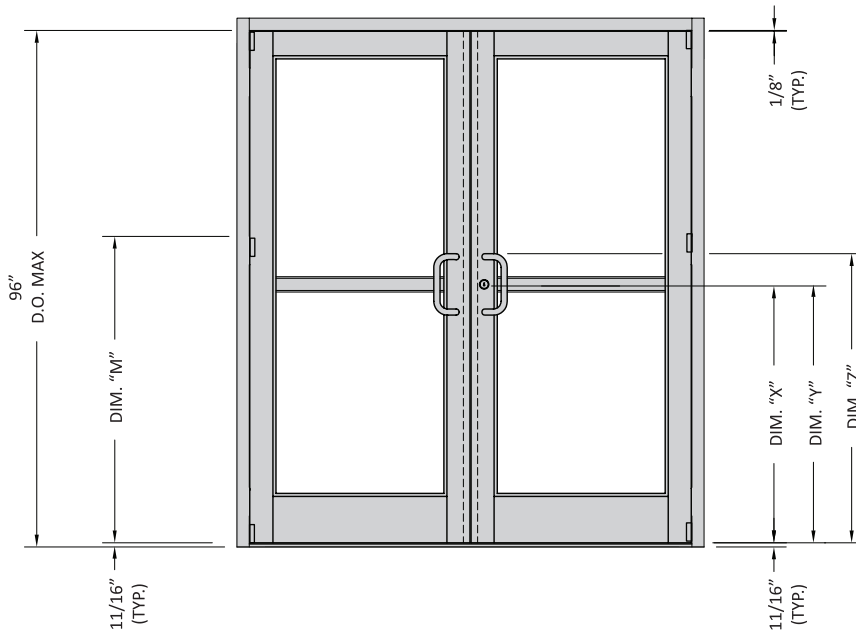

OFFSET INTERMEDIATE PIVOT LOCATION	
D.O. HEIGHT	DIM. "M"
	Offset Pivot
84"	43 <sup>27</sup> / <sub>32</sub> "
96"	49 <sup>27</sup> / <sub>32</sub> "

**Note:** D.O.H. exceeding 90" or D.O.W. exceeding 42" require an intermediate offset pivot.

HARDWARE LOCATIONS FOR PANIC DOORS				
MANUFACTURER	PANIC DEVICE	DIM "X" OF CYLINDER	DIM "Y" OF PANIC	DIM "Z" TOP OF PULL
FIRST CHOICE	3192 Mid Panel	39 <sup>5</sup> / <sub>32</sub> "	41 <sup>3</sup> / <sub>32</sub> "	44 <sup>5</sup> / <sub>32</sub> "
FIRST CHOICE	3692 C.V.R.	41 <sup>9</sup> / <sub>16</sub> "	40 <sup>5</sup> / <sub>8</sub> "	46 <sup>9</sup> / <sub>16</sub> "
FIRST CHOICE	3792 RIM	41 <sup>9</sup> / <sub>16</sub> "	41 <sup>5</sup> / <sub>16</sub> "	46 <sup>9</sup> / <sub>16</sub> "

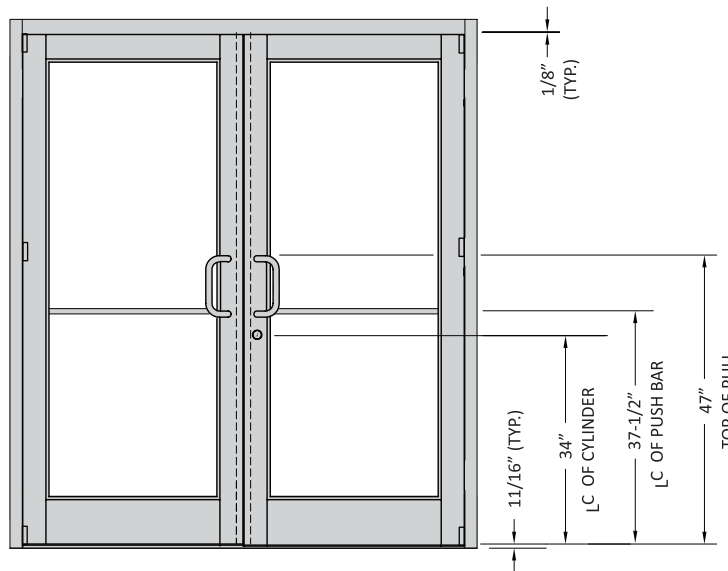

**Note:** Medium Stile Doors used for Illustration Purposes. Hardware locations are similar for Narrow and Wide Stile Doors



Butt Hinge

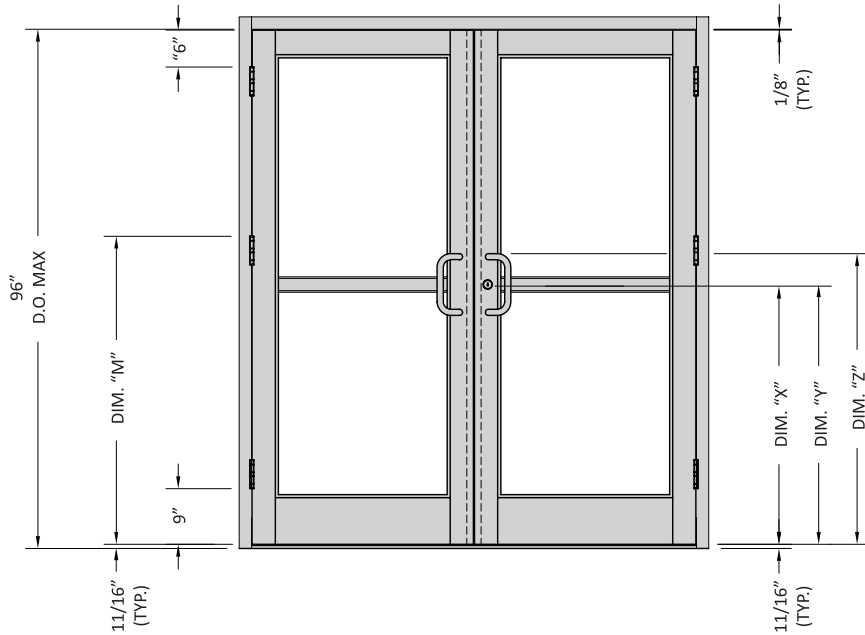

INTERMEDIATE HINGE	
D.O. HEIGHT	DIM. "M"
	BUTT HINGE
84"	45 <sup>11</sup> / <sub>32</sub> "
96"	51 <sup>11</sup> / <sub>32</sub> "

**Note:** D.O.H. exceeding 90" or D.O.W. exceeding 42" require an intermediate hinge.

HARDWARE LOCATIONS FOR PANIC DOORS				
MANUFACTURER	PANIC DEVICE	DIM "X" OF CYLINDER	DIM "Y" OF PANIC	DIM "Z" TOP OF PULL
FIRST CHOICE	3192 Mid Panel	39 <sup>5</sup> / <sub>32</sub> "	41 <sup>3</sup> / <sub>32</sub> "	44 <sup>5</sup> / <sub>32</sub> "
FIRST CHOICE	3692 C.V.R.	41 <sup>9</sup> / <sub>16</sub> "	40 <sup>5</sup> / <sub>8</sub> "	46 <sup>9</sup> / <sub>16</sub> "
FIRST CHOICE	3792 RIM	41 <sup>9</sup> / <sub>16</sub> "	41 <sup>5</sup> / <sub>16</sub> "	46 <sup>9</sup> / <sub>16</sub> "

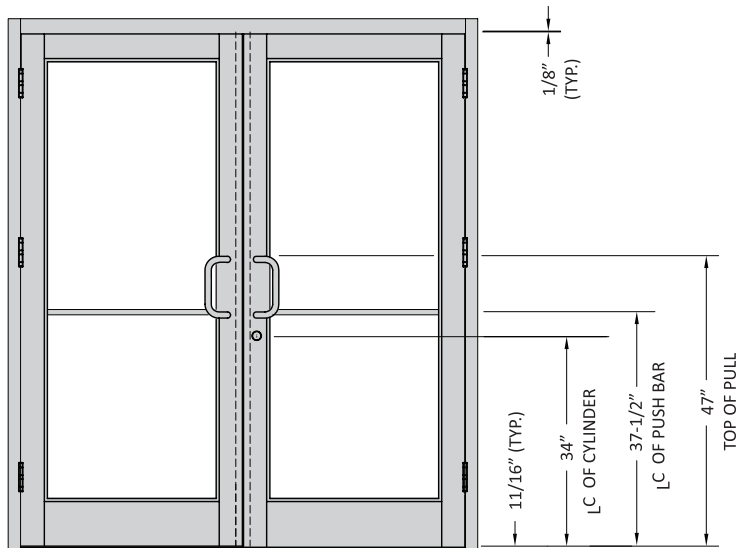

Note: Medium Stile Doors used for Illustration Purposes. Hardware locations are similar for Narrow and Wide Stile Doors

# Entrances

## Standard Doors • Offset Pivot



### Offset Pivot Door Package Includes

- Traditional 1" rd Pull/Push Hardware
- Glass Stops for ¼" Glazing
- Top & Bottom Door Pivots
- MS Hook Bolt - Single or Active Leaf
- Top & Bottom Flush Bolts Inactive Leaf
- Keyed Cylinder Exterior
- Thumb Turn Interior

Note: Reference Hardware Section of the Price Catalog for Door Closers and Loose Hardware Items not included in Standard Entrance section.

Note: All Hardware on Powder coat products is furnished in a standard clear finish.

Order Number Example: 3684MS-D (Size and Series) - (Hand or Pair)



SERIES 213 NARROW STILE						
HAND	DESCRIPTION	FINISH CODE / DOOR PRICE				
		#11 CLEAR	#21 BRONZE	#81 WHITE	#2604 POWDER	#2605 POWDER
RH	3684-C	\$569	\$610	\$610	\$746	\$823
LH	3684-D	\$569	\$610	\$610	\$746	\$823
RH	4284-C	\$707	\$731	\$731	\$855	\$936
LH	4284-D	\$707	\$731	\$731	\$855	\$936
PAIR	7284-K	\$1,133	\$1,195	\$1,195	\$1,600	\$1,725



SERIES 380 MEDIUM STILE						
HAND	DESCRIPTION	FINISH CODE / DOOR PRICE				
		#11 CLEAR	#21 BRONZE	#81 WHITE	#2604 POWDER	#2605 POWDER
RH	3684MS-C	\$740	\$770	\$770	\$904	\$990
LH	3684MS-D	\$740	\$770	\$770	\$904	\$990
RH	4284MS-C	\$789	\$812	\$812	\$936	\$1,052
LH	4284MS-D	\$789	\$812	\$812	\$936	\$1,052
PAIR	7284MS-K	\$1,553	\$1,618	\$1,618	\$1,877	\$2,019



SERIES 500 WIDE STILE						
HAND	DESCRIPTION	FINISH CODE / DOOR PRICE				
		#11 CLEAR	#21 BRONZE	#81 WHITE	#2604 POWDER	#2605 POWDER
RH	3684WS-C	\$810	\$840	\$840	\$988	\$1,080
LH	3684WS-D	\$810	\$840	\$840	\$988	\$1,080
RH	4284WS-C	\$857	\$882	\$882	\$1,048	\$1,143
LH	4284WS-D	\$857	\$882	\$882	\$1,048	\$1,143
PAIR	7284WS-K	\$1,661	\$1,725	\$1,725	\$2,016	\$2,167

Note: Add "DM001" to substitute DG101 Glass Stops used for 1" Insulated Glass.

**Offset Pivot Frame Package Includes**

- 1 1/4" or 2" x 4 1/2" Open Back Frame
- Snap-in DS200 Door Stop w/pile
- 1/2" x 4" Threshold – Mill Finish

- Prep for Top & Bottom Pivots
- Prep for Top & Bottom Flush Bolts (pair)
- Frame assembly fastener package

- Threshold
- Top & Bottom
- Prep for L

Note: All Hardware on Powder coat products is furnished in a standard clear finish.

Note: Standard Frame Height for Transom Frames = 10'-5 1/2".

Order Number Example: 3684-D-FT2 (Size) - (Hand or Pair) - (Type)

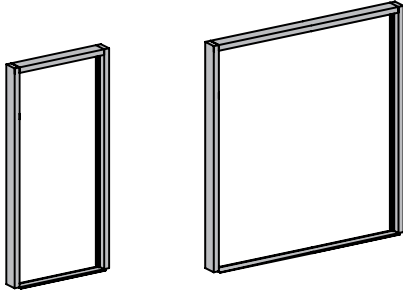

FL200 DOOR FRAME (Non-Transom)						
HAND	DESCRIPTION	FINISH CODE / FRAME PRICE				
		#11 CLEAR	#21 BRONZE	#81 WHITE	#2604 POWDER	#2605 POWDER
RH	3684-C-F2	\$358	\$368	\$368	\$507	\$548
LH	3684-D-F2	\$358	\$368	\$368	\$507	\$548
RH	4284-C-F2	\$401	\$412	\$412	\$521	\$562
LH	4284-D-F2	\$401	\$412	\$412	\$521	\$562
PAIR	7284-K-F2	\$436	\$447	\$447	\$616	\$665

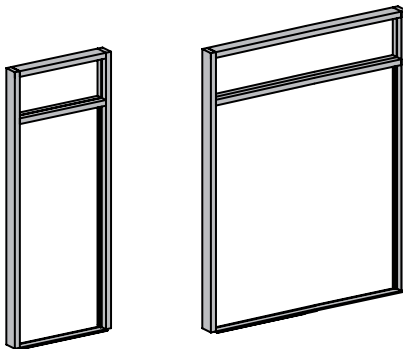

FL200 DOOR FRAME WITH TRANSOM						
HAND	DESCRIPTION	FINISH CODE / FRAME PRICE				
		#11 CLEAR	#21 BRONZE	#81 WHITE	#2604 POWDER	#2605 POWDER
RH	3684-C-FT2	\$472	\$488	\$488	\$721	\$776
LH	3684-D-FT2	\$472	\$488	\$488	\$721	\$776
RH	4284-C-FT2	\$581	\$597	\$597	\$742	\$798
LH	4284-D-FT2	\$581	\$597	\$597	\$742	\$798
PAIR	7284-K-FT2	\$591	\$610	\$610	\$879	\$947

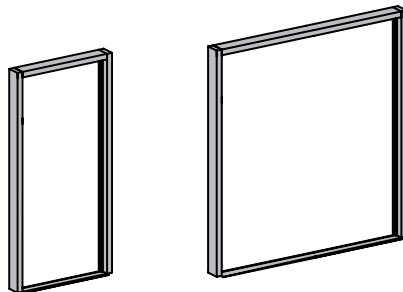

FL300 DOOR FRAME (Non-Transom)						
HAND	DESCRIPTION	FINISH CODE / FRAME PRICE				
		#11 CLEAR	#21 BRONZE	#81 WHITE	#2604 POWDER	#2605 POWDER
RH	3684-C-F3	\$368	\$378	\$378	\$520	\$560
LH	3684-D-F3	\$368	\$378	\$378	\$520	\$560
RH	4284-C-F3	\$411	\$423	\$423	\$534	\$576
LH	4284-D-F3	\$411	\$423	\$423	\$534	\$576
PAIR	7284-K-F3	\$448	\$460	\$460	\$634	\$682

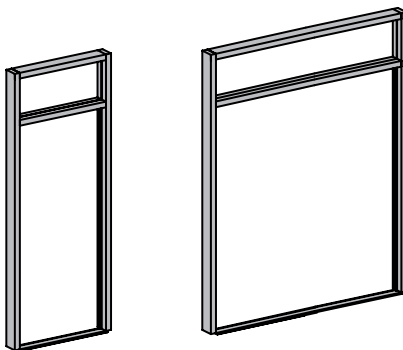

FL300 DOOR FRAME WITH TRANSOM						
HAND	DESCRIPTION	FINISH CODE / FRAME PRICE				
		#11 CLEAR	#21 BRONZE	#81 WHITE	#2604 POWDER	#2605 POWDER
RH	3684-C-FT3	\$523	\$543	\$543	\$829	\$896
LH	3684-D-FT3	\$523	\$543	\$543	\$829	\$896
RH	4284-C-FT3	\$649	\$670	\$670	\$850	\$917
LH	4284-D-FT3	\$649	\$670	\$670	\$850	\$917
PAIR	7284-K-FT3	\$648	\$672	\$672	\$994	\$1,075

# Entrances

## Standard Doors • Offset Pivot



### Offset Pivot Door Package Includes

- Traditional 1" rd Pull/Push Hardware
- Glass Stops for ¼" Glazing
- Top, Bottom & Intermediate Door Pivots
- MS Hook Bolt - Single or Active Leaf
- Top & Bottom Flush Bolts Inactive Leaf
- Keyed Cylinder Exterior
- Thumb Turn Interior

*Note: Reference Hardware Section of the Price Catalog for Door Closers and Loose Hardware Items not included in Standard Entrance section.  
Note: All Hardware on Powder coat products is furnished in a standard clear finish.*

Order Number Example: **3696MS-D** (Size and Series) - (Hand or Pair)



SERIES 213 NARROW STILE						
HAND	DESCRIPTION	FINISH CODE / DOOR PRICE				
		#11 CLEAR	#21 BRONZE	#81 WHITE	#2604 POWDER	#2605 POWDER
RH	3696-C	\$763	\$797	\$797	\$920	\$1,003
LH	3696-D	\$763	\$797	\$797	\$920	\$1,003
RH	4296-C	\$812	\$836	\$836	\$976	\$1,061
LH	4296-D	\$812	\$836	\$836	\$976	\$1,061
PAIR	7296-K	\$1,575	\$1,640	\$1,640	\$1,859	\$1,990



SERIES 380 MEDIUM STILE						
HAND	DESCRIPTION	FINISH CODE / DOOR PRICE				
		#11 CLEAR	#21 BRONZE	#81 WHITE	#2604 POWDER	#2605 POWDER
RH	3696MS-C	\$846	\$879	\$879	\$1,029	\$1,122
LH	3696MS-D	\$846	\$879	\$879	\$1,029	\$1,122
RH	4296MS-C	\$899	\$924	\$924	\$1,093	\$1,188
LH	4296MS-D	\$899	\$924	\$924	\$1,093	\$1,188
PAIR	7296MS-K	\$1,764	\$1,838	\$1,838	\$2,131	\$2,285



SERIES 500 WIDE STILE						
HAND	DESCRIPTION	FINISH CODE / DOOR PRICE				
		#11 CLEAR	#21 BRONZE	#81 WHITE	#2604 POWDER	#2605 POWDER
RH	3696WS-C	\$922	\$954	\$954	\$1,123	\$1,221
LH	3696WS-D	\$922	\$954	\$954	\$1,123	\$1,221
RH	4296WS-C	\$975	\$1,000	\$1,000	\$1,187	\$1,288
LH	4296WS-D	\$975	\$1,000	\$1,000	\$1,187	\$1,288
PAIR	7296WS-K	\$1,890	\$1,958	\$1,958	\$2,286	\$2,452

*Note: Add "DM001" to substitute DG101 Glass Stops used for 1" Insulated Glass.*

**Offset Pivot Frame Package Includes**

- 1 1/4" or 2" x 4 1/2" Open Back Frame
- Snap-in DS200 Door Stop w/pile
- 1/2" x 4" Threshold – Mill Finish
- Threshold Clips
- Top & Bottom Frame Pivots
- Prep for Lock Strike
- Prep for Top, Bottom & Intermediate Pivots
- Prep for Top & Bottom Flush Bolts (pair)
- Frame assembly fastener package

Note: All Hardware on Powder coat products is furnished in a standard clear finish.

Note: Standard Frame Height for Transom Frames = 10'-5 1/2".

Order Number Example: 3696-D-FT2 (Size) - (Hand or Pair) - (Type)

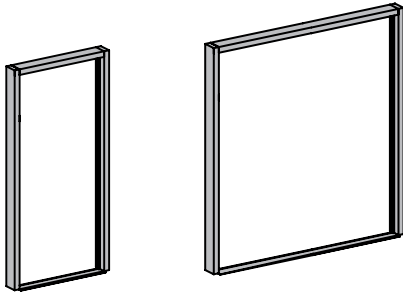

FL200 DOOR FRAME (Non-Transom)						
HAND	DESCRIPTION	FINISH CODE / FRAME PRICE				
		#11 CLEAR	#21 BRONZE	#81 WHITE	#2604 POWDER	#2605 POWDER
RH	3696-C-F2	\$441	\$452	\$452	\$570	\$615
LH	3696-D-F2	\$441	\$452	\$452	\$570	\$615
RH	4296-C-F2	\$450	\$462	\$462	\$584	\$630
LH	4296-D-F2	\$450	\$462	\$462	\$584	\$630
PAIR	7296-K-F2	\$528	\$540	\$540	\$686	\$738

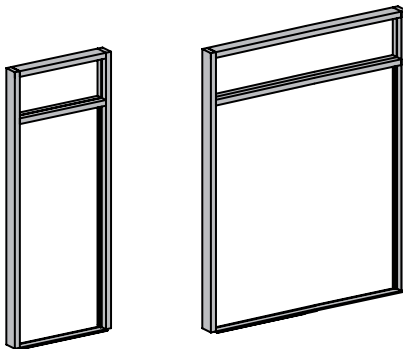

FL200 DOOR FRAME WITH TRANSMOM						
HAND	DESCRIPTION	FINISH CODE / FRAME PRICE				
		#11 CLEAR	#21 BRONZE	#81 WHITE	#2604 POWDER	#2605 POWDER
RH	3696-C-FT2	\$594	\$610	\$610	\$753	\$809
LH	3696-D-FT2	\$594	\$610	\$610	\$753	\$809
RH	4296-C-FT2	\$608	\$625	\$625	\$774	\$833
LH	4296-D-FT2	\$608	\$625	\$625	\$774	\$833
PAIR	7296-K-FT2	\$719	\$738	\$738	\$917	\$986

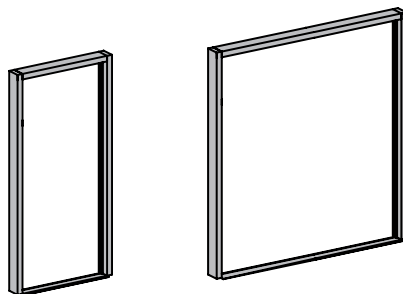

FL300 DOOR FRAME (Non-Transom)						
HAND	DESCRIPTION	FINISH CODE / FRAME PRICE				
		#11 CLEAR	#21 BRONZE	#81 WHITE	#2604 POWDER	#2605 POWDER
RH	3696-C-F3	\$453	\$465	\$465	\$584	\$630
LH	3696-D-F3	\$453	\$465	\$465	\$584	\$630
RH	4296-C-F3	\$461	\$474	\$474	\$598	\$646
LH	4296-D-F3	\$461	\$474	\$474	\$598	\$646
PAIR	7296-K-F3	\$541	\$559	\$559	\$704	\$758

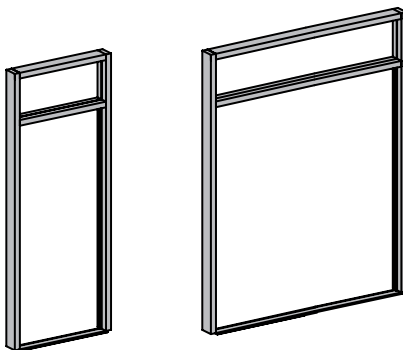

FL300 DOOR FRAME WITH TRANSMOM						
HAND	DESCRIPTION	FINISH CODE / FRAME PRICE				
		#11 CLEAR	#21 BRONZE	#81 WHITE	#2604 POWDER	#2605 POWDER
RH	3696-C-FT3	\$649	\$668	\$668	\$836	\$900
LH	3696-D-FT3	\$649	\$668	\$668	\$836	\$900
RH	4296-C-FT3	\$663	\$682	\$682	\$836	\$900
LH	4296-D-FT3	\$663	\$682	\$682	\$836	\$900
PAIR	7296-K-FT3	\$769	\$792	\$792	\$1,005	\$1,085

# Entrances

## Standard Doors • Offset Pivot/Panic



### Offset Pivot CVR Panic Door Package Includes

- Traditional 1" rd Panic Pull
- Glass Stops for ¼" Glazing
- Top & Bottom Door Pivots
- DH3692 CVR Touch Bar Panic(s)
- Keyed Cylinder Exterior - Single or Active Leaf

Note: Reference Hardware Section of the Price Catalog for Door Closers and Loose Hardware Items not included in Standard Entrance section.  
 Note: All Hardware on Powder coat products is furnished in a standard clear finish.

Order Number Example: 3684MS-DP (Size and Series) - (Hand or Pair)



SERIES 213 NARROW STILE						
HAND	DESCRIPTION	FINISH CODE / DOOR PRICE				
		#11 CLEAR	#21 BRONZE	#81 WHITE	#2604 POWDER	#2605 POWDER
RH	3684-CP	\$920	\$938	\$938	\$1,184	\$1,261
LH	3684-DP	\$920	\$938	\$938	\$1,184	\$1,261
RH	4284-CP	\$1091	\$1,108	\$1,108	\$1,230	\$1,311
LH	4284-DP	\$1091	\$1,108	\$1,108	\$1,230	\$1,311
PAIR	7284-KP	\$1,880	\$1,915	\$1,915	\$2,400	\$2,520



SERIES 380 MEDIUM STILE						
HAND	DESCRIPTION	FINISH CODE / DOOR PRICE				
		#11 CLEAR	#21 BRONZE	#81 WHITE	#2604 POWDER	#2605 POWDER
RH	3684MS-CP	\$1,137	\$1,154	\$1,157	\$1,295	\$1,381
LH	3684MS-DP	\$1,137	\$1,154	\$1,157	\$1,295	\$1,381
RH	4284MS-CP	\$1,171	\$1,188	\$1,188	\$1,338	\$1,427
LH	4284MS-DP	\$1,171	\$1,188	\$1,188	\$1,338	\$1,427
PAIR	7284MS-KP	\$2,352	\$2,389	\$2,389	\$2,661	\$2,803



SERIES 500 WIDE STILE						
HAND	DESCRIPTION	FINISH CODE / DOOR PRICE				
		#11 CLEAR	#21 BRONZE	#81 WHITE	#2604 POWDER	#2605 POWDER
RH	3684WS-CP	\$1,207	\$1,225	\$1,225	\$1,380	\$1,470
LH	3684WS-DP	\$1,207	\$1,225	\$1,225	\$1,380	\$1,470
RH	4284WS-CP	\$1,241	\$1,258	\$1,258	\$1,424	\$1,518
LH	4284WS-DP	\$1,241	\$1,258	\$1,258	\$1,424	\$1,518
PAIR	7284WS-KP	\$2,460	\$2,498	\$2,498	\$2,798	\$2,951

Note: Add "DM001" to substitute DG101 Glass Stops used for 1" Insulated Glass.

**Offset Pivot CVR Panic Frame Package Includes**

- 1 1/4" or 2" x 4 1/2" Open Back Frame
- Snap-in DS200 Door Stop w/pile
- 1/2" x 4" Threshold – Mill Finish
- Threshold Clips
- Top & Bottom Frame Pivots
- Prep for DH3692 CVR Panic(s)
- Prep for Top & Bottom Pivots
- Frame assembly fastener package

Note: All Hardware on Powder coat products is furnished in a standard clear finish.

Note: Standard Frame Height for Transom Frames = 10'-5 1/2".

Order Number Example: **3684-DP-F2** (Size) - (Hand or Pair) - (Type)

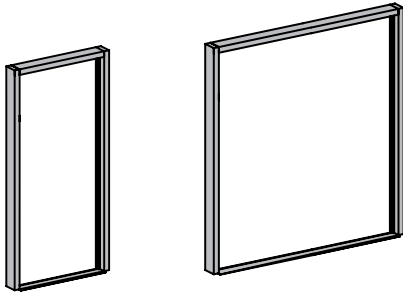

FL200 DOOR FRAME (Non-Transom)						
HAND	DESCRIPTION	FINISH CODE / FRAME PRICE				
		#11 CLEAR	#21 BRONZE	#81 WHITE	#2604 POWDER	#2605 POWDER
RH	3684-CP-F2	\$383	\$394	\$394	\$527	\$566
LH	3684-DP-F2	\$383	\$394	\$394	\$527	\$566
RH	4284-CP-F2	\$419	\$430	\$430	\$541	\$581
LH	4284-DP-F2	\$419	\$430	\$430	\$541	\$581
PAIR	7284-KP-F2	\$460	\$473	\$473	\$634	\$682

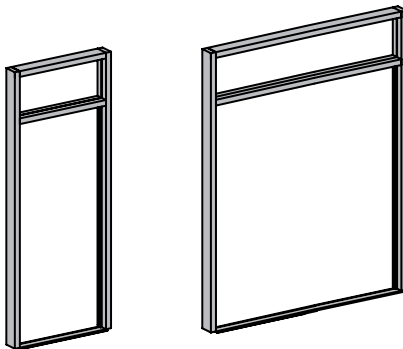

FL200 DOOR FRAME WITH TRANSOM						
HAND	DESCRIPTION	FINISH CODE / FRAME PRICE				
		#11 CLEAR	#21 BRONZE	#81 WHITE	#2604 POWDER	#2605 POWDER
RH	3684-CP-FT2	\$529	\$543	\$543	\$741	\$794
LH	3684-DP-FT2	\$529	\$543	\$543	\$741	\$794
RH	4284-CP-FT2	\$601	\$617	\$617	\$762	\$818
LH	4284-DP-FT2	\$601	\$617	\$617	\$762	\$818
PAIR	7284-KP-FT2	\$646	\$665	\$665	\$898	\$963

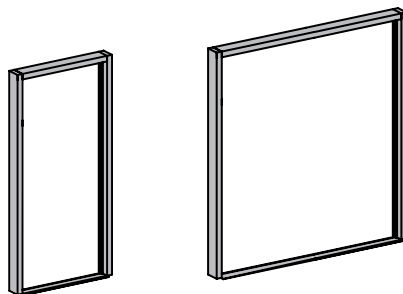

FL300 DOOR FRAME (Non-Transom)						
HAND	DESCRIPTION	FINISH CODE / FRAME PRICE				
		#11 CLEAR	#21 BRONZE	#81 WHITE	#2604 POWDER	#2605 POWDER
RH	3684-CP-F3	\$393	\$403	\$403	\$539	\$580
LH	3684-DP-F3	\$393	\$403	\$403	\$539	\$580
RH	4284-CP-F3	\$432	\$441	\$441	\$553	\$595
LH	4284-DP-F3	\$432	\$441	\$441	\$553	\$595
PAIR	7284-KP-F3	\$458	\$470	\$470	\$651	\$700

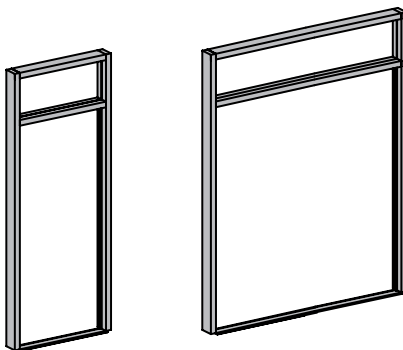

FL300 DOOR FRAME WITH TRANSOM						
HAND	DESCRIPTION	FINISH CODE / FRAME PRICE				
		#11 CLEAR	#21 BRONZE	#81 WHITE	#2604 POWDER	#2605 POWDER
RH	3684-CP-FT3	\$581	\$601	\$601	\$849	\$914
LH	3684-DP-FT3	\$581	\$601	\$601	\$849	\$914
RH	4284-CP-FT3	\$667	\$688	\$688	\$886	\$937
LH	4284-DP-FT3	\$667	\$688	\$688	\$886	\$937
PAIR	7284-KP-FT3	\$658	\$685	\$685	\$1,012	\$1,092



# Entrances

## Standard Doors • Offset Pivot/Panic

### Offset Pivot CVR Panic Door Package Includes

- Traditional 1" rd Panic Pull
- DH3692 CVR Touch Bar Panic(s)
- Glass Stops for ¼" Glazing
- Keyed Cylinder Exterior - Single or Active Leaf
- Top, Bottom, & Intermediate Door Pivots

Note: Reference Hardware Section of the Price Catalog for Door Closers and Loose Hardware Items not included in Standard Entrance section.

Note: All Hardware on Powder coat products is furnished in a standard clear finish.

Order Number Example: 3696MS-DP (Size and Series) - (Hand or Pair)



SERIES 213 NARROW STILE						
HAND	DESCRIPTION	FINISH CODE / DOOR PRICE				
		#11 CLEAR	#21 BRONZE	#81 WHITE	#2604 POWDER	#2605 POWDER
RH	3696-CP	\$1,164	\$1,181	\$1,181	\$1,310	\$1,395
LH	3696-DP	\$1,164	\$1,181	\$1,181	\$1,310	\$1,395
RH	4296-CP	\$1,195	\$1,214	\$1,214	\$1,351	\$1,437
LH	4296-DP	\$1,195	\$1,214	\$1,214	\$1,351	\$1,437
PAIR	7296-KP	\$2,378	\$2,416	\$2,416	\$2,646	\$2,776



SERIES 380 MEDIUM STILE						
HAND	DESCRIPTION	FINISH CODE / DOOR PRICE				
		#11 CLEAR	#21 BRONZE	#81 WHITE	#2604 POWDER	#2605 POWDER
RH	3696MS-CP	\$1,245	\$1,264	\$1,264	\$1,419	\$1,512
LH	3696MS-DP	\$1,245	\$1,264	\$1,264	\$1,419	\$1,512
RH	4296MS-CP	\$1,281	\$1,301	\$1,301	\$1,467	\$1,563
LH	4296MS-DP	\$1,281	\$1,301	\$1,301	\$1,467	\$1,563
PAIR	7296MS-KP	\$2,571	\$2,611	\$2,611	\$2,915	\$3,069



SERIES 500 WIDE STILE						
HAND	DESCRIPTION	FINISH CODE / DOOR PRICE				
		#11 CLEAR	#21 BRONZE	#81 WHITE	#2604 POWDER	#2605 POWDER
RH	3696WS-CP	\$1,321	\$1,339	\$1,339	\$1,513	\$1,612
LH	3696WS-DP	\$1,321	\$1,339	\$1,339	\$1,513	\$1,612
RH	4296WS-CP	\$1,357	\$1,378	\$1,378	\$1,562	\$1,663
LH	4296WS-DP	\$1,357	\$1,378	\$1,378	\$1,562	\$1,663
PAIR	7296WS-KP	\$2,690	\$2,729	\$2,729	\$3,070	\$3,236

Note: Add "DM001" to substitute DG101 Glass Stops used for 1" Insulated Glass.



**Offset Pivot CVR Panic Frame Package Includes**

- 1 1/4" or 2" x 4 1/2" Open Back Frame
- Snap-in DS200 Door Stop w/pile
- 1/2" x 4" Threshold – Mill Finish
- Threshold Clips
- Top & Bottom Frame Pivots
- Prep for DH3692 CVR Panic(s)
- Prep for Intermediate Pivots
- Frame assembly fastener package

Note: All Hardware on Powder coat products is furnished in a standard clear finish.

Note: Standard Frame Height for Transom Frames = 10'-5 1/2".

Order Number Example: **3684-DP-FT2** (Size) - (Hand or Pair) - (Type)

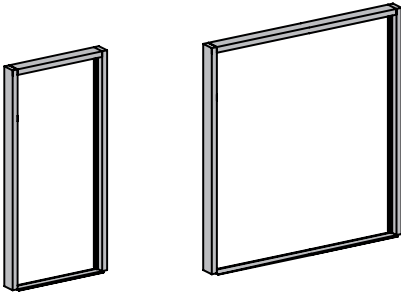

FL200 DOOR FRAME (Non-Transom)						
HAND	DESCRIPTION	FINISH CODE / FRAME PRICE				
		#11 CLEAR	#21 BRONZE	#81 WHITE	#2604 POWDER	#2605 POWDER
RH	3696-CP-F2	\$460	\$472	\$472	\$590	\$633
LH	3696-DP-F2	\$460	\$472	\$472	\$590	\$633
RH	4296-CP-F2	\$469	\$481	\$481	\$604	\$648
LH	4296-DP-F2	\$469	\$481	\$481	\$604	\$648
PAIR	7296-KP-F2	\$546	\$559	\$559	\$703	\$756

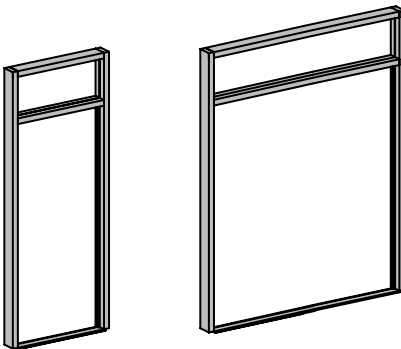

FL200 DOOR FRAME WITH TRANSOM						
HAND	DESCRIPTION	FINISH CODE / FRAME PRICE				
		#11 CLEAR	#21 BRONZE	#81 WHITE	#2604 POWDER	#2605 POWDER
RH	3696-CP-FT2	\$612	\$628	\$628	\$773	\$828
LH	3696-DP-FT2	\$612	\$628	\$628	\$773	\$828
RH	4296-CP-FT2	\$628	\$643	\$643	\$794	\$851
LH	4296-DP-FT2	\$628	\$643	\$643	\$794	\$851
PAIR	7296-KP-FT2	\$737	\$756	\$756	\$935	\$1,004

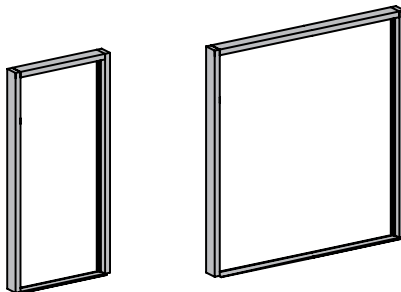

FL300 DOOR FRAME (Non-Transom)						
HAND	DESCRIPTION	FINISH CODE / FRAME PRICE				
		#11 CLEAR	#21 BRONZE	#81 WHITE	#2604 POWDER	#2605 POWDER
RH	3696-CP-F3	\$471	\$483	\$483	\$604	\$648
LH	3696-DP-F3	\$471	\$483	\$483	\$604	\$648
RH	4296-CP-F3	\$481	\$493	\$493	\$618	\$665
LH	4296-DP-F3	\$481	\$493	\$493	\$618	\$665
PAIR	7296-KP-F3	\$562	\$578	\$578	\$723	\$776

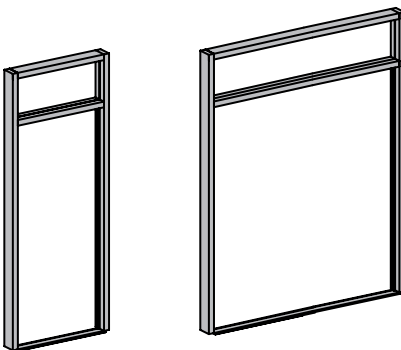

FL300 DOOR FRAME WITH TRANSOM						
HAND	DESCRIPTION	FINISH CODE / FRAME PRICE				
		#11 CLEAR	#21 BRONZE	#81 WHITE	#2604 POWDER	#2605 POWDER
RH	3696-CP-FT3	\$667	\$686	\$686	\$856	\$919
LH	3696-DP-FT3	\$667	\$686	\$686	\$856	\$919
RH	4296-CP-FT3	\$681	\$700	\$700	\$875	\$941
LH	4296-DP-FT3	\$681	\$700	\$700	\$875	\$941
PAIR	7296-KP-FT3	\$786	\$811	\$811	\$1,024	\$1,102

# Entrances

## Standard Doors • Offset Pivot/Offset Arm



### Offset Pivot - Offset Arm Door Package Includes

- Traditional 1" rd Pull/Push Hardware
- Glass Stops for ¼" Glazing
- Top & Bottom Door Pivots
- Slide Channel installed with Offset Arm
- MS Hook Bolt - Single or Active Leaf
- Top & Bottom Flush Bolts Inactive Leaf
- Keyed Cylinder Exterior
- Thumb Turn Interior

Note: Reference Hardware Section of the Price Catalog for Door Closers and Loose Hardware Items not included in Standard Entrance section.

Note: All Hardware on Powder coat products is furnished in a standard clear finish.

Note: D102 Top Rail on Narrow Stile Doors with offset arm. DH100 Intermediate pivot used as top pivot.

Order Number Example: 3684MS-DO(Size and Series) - (Hand or Pair)



SERIES 213 NARROW STILE						
HAND	DESCRIPTION	FINISH CODE / DOOR PRICE				
		#11 CLEAR	#21 BRONZE	#81 WHITE	#2604 POWDER	#2605 POWDER
RH	3684-CO	\$866	\$896	\$896	\$1,006	\$1,076
LH	3684-DO	\$866	\$896	\$896	\$1,006	\$1,076
RH	4284-CO	\$910	\$933	\$933	\$1,060	\$1,141
LH	4284-DO	\$910	\$933	\$933	\$1,060	\$1,141
PAIR	7284-KO	\$1,773	\$1,834	\$1,834	\$2,030	\$2,155



SERIES 380 MEDIUM STILE						
HAND	DESCRIPTION	FINISH CODE / DOOR PRICE				
		#11 CLEAR	#21 BRONZE	#81 WHITE	#2604 POWDER	#2605 POWDER
RH	3684MS-CO	\$926	\$960	\$960	\$1,090	\$1,176
LH	3684MS-DO	\$926	\$960	\$960	\$1,090	\$1,176
RH	4284MS-CO	\$979	\$1,000	\$1,000	\$1,149	\$1,239
LH	4284MS-DO	\$979	\$1,000	\$1,000	\$1,149	\$1,239
PAIR	7284MS-KO	\$1,935	\$1,996	\$1,996	\$2,251	\$2,393



SERIES 500 WIDE STILE						
HAND	DESCRIPTION	FINISH CODE / DOOR PRICE				
		#11 CLEAR	#21 BRONZE	#81 WHITE	#2604 POWDER	#2605 POWDER
RH	3684WS-CO	\$1,000	\$1,030	\$1,030	\$1,176	\$1,267
LH	3684WS-DO	\$1,000	\$1,030	\$1,030	\$1,176	\$1,267
RH	4284WS-CO	\$1,049	\$1,071	\$1,071	\$1,235	\$1,329
LH	4284WS-DO	\$1,049	\$1,071	\$1,071	\$1,235	\$1,329
PAIR	7284WS-KO	\$2,042	\$2,103	\$2,103	\$2,390	\$2,541

Note: Add "DM001" to substitute DG101 Glass Stops used for 1" Insulated Glass.

**Offset Pivot CVR Panic Frame Package Includes**

- 1¾" or 2" x 4½" Open Back Frame
- Snap-in DS200 Door Stop w/pile
- ½" x 4" Threshold – Mill Finish
- Threshold Clips
- Bottom Frame Pivots
- Prepped for DH100 Top Pivot
- Prep for Lock Strike
- Prep for COC
- Frame assembly fastener package
- Applied DS202 Header Door stop

Note: All Hardware on Powder coat products is furnished in a standard clear finish.

Note: Standard Frame Height for Transom Frames = 10'-5 ½".

Order Number Example: 3684-DO-FT2 (Size) - (Hand or Pair) - (Type)

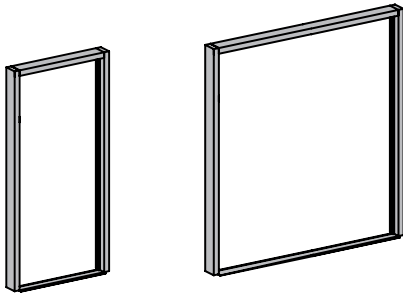

FL200 DOOR FRAME (Non-Transom)						
HAND	DESCRIPTION	FINISH CODE / FRAME PRICE				
		#11 CLEAR	#21 BRONZE	#81 WHITE	#2604 POWDER	#2605 POWDER
RH	3684-CO-F2	\$537	\$546	\$546	\$654	\$695
LH	3684-DO-F2	\$537	\$546	\$546	\$654	\$695
RH	4284-CO-F2	\$546	\$554	\$554	\$668	\$711
LH	4284-DO-F2	\$546	\$554	\$554	\$668	\$711
PAIR	7284-KO-F2	\$667	\$677	\$677	\$815	\$865

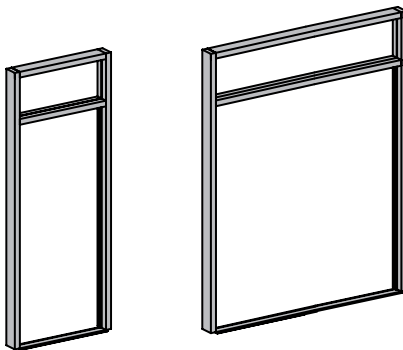

FL200 DOOR FRAME WITH TRANSOM						
HAND	DESCRIPTION	FINISH CODE / FRAME PRICE				
		#11 CLEAR	#21 BRONZE	#81 WHITE	#2604 POWDER	#2605 POWDER
RH	3684-CO-FT2	\$749	\$764	\$764	\$926	\$987
LH	3684-DO-FT2	\$749	\$764	\$764	\$926	\$987
RH	4284-CO-FT2	\$765	\$781	\$781	\$954	\$1,018
LH	4284-DO-FT2	\$765	\$781	\$781	\$954	\$1,018
PAIR	7284-KO-FT2	\$926	\$946	\$946	\$1,168	\$1,249

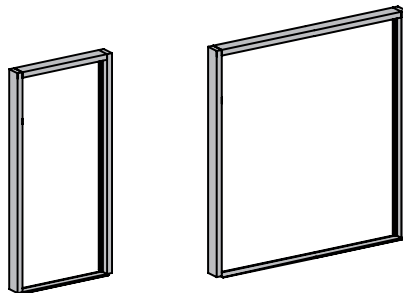

FL300 DOOR FRAME (Non-Transom)						
HAND	DESCRIPTION	FINISH CODE / FRAME PRICE				
		#11 CLEAR	#21 BRONZE	#81 WHITE	#2604 POWDER	#2605 POWDER
RH	3684-CO-F3	\$556	\$566	\$566	\$678	\$720
LH	3684-DO-F3	\$556	\$566	\$566	\$678	\$720
RH	4284-CO-F3	\$566	\$576	\$576	\$693	\$737
LH	4284-DO-F3	\$566	\$576	\$576	\$693	\$737
PAIR	7284-KO-F3	\$695	\$706	\$706	\$850	\$900

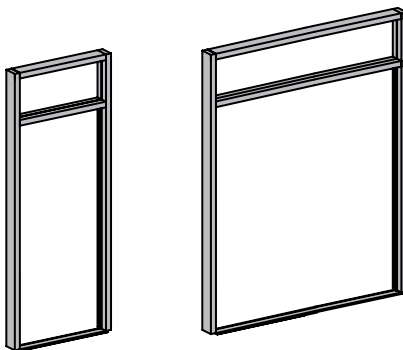

FL300 DOOR FRAME WITH TRANSOM						
HAND	DESCRIPTION	FINISH CODE / FRAME PRICE				
		#11 CLEAR	#21 BRONZE	#81 WHITE	#2604 POWDER	#2605 POWDER
RH	3684-CO-FT3	\$829	\$848	\$848	\$1,049	\$1,123
LH	3684-DO-FT3	\$829	\$848	\$848	\$1,049	\$1,123
RH	4284-CO-FT3	\$846	\$868	\$868	\$1,077	\$1,152
LH	4284-DO-FT3	\$846	\$868	\$868	\$1,077	\$1,152
PAIR	7284-KO-FT3	\$1,011	\$1,035	\$1,035	\$1,306	\$1,402

# Entrances

## Standard Doors • Offset Pivot/Offset Arm



### Offset Pivot - Offset Arm Door Package Includes

- Traditional 1" rd Pull/Push Hardware
- Glass Stops for ¼" Glazing
- Top, Bottom, & Intermediate Door Pivots
- Slide Channel installed with Offset Arm
- MS Hook Bolt - Single or Active Leaf
- Top & Bottom Flush Bolts Inactive Leaf
- Keyed Cylinder Exterior
- Thumb Turn Interior

Note: Reference Hardware Section of the Price Catalog for Door Closers and Loose Hardware Items not included in Standard Entrance section.

Note: All Hardware on Powder coat products is furnished in a standard clear finish.

Note: D102 Top Rail on Narrow Stile Doors with offset arm. DH100 Intermediate pivot used as top pivot.

Order Number Example: 3696MS-DO (Size and Series) - (Hand or Pair)



SERIES 213 NARROW STILE						
HAND	DESCRIPTION	FINISH CODE / DOOR PRICE				
		#11 CLEAR	#21 BRONZE	#81 WHITE	#2604 POWDER	#2605 POWDER
RH	3696-CO	\$965	\$996	\$996	\$1,121	\$1,206
LH	3696-DO	\$965	\$996	\$996	\$1,121	\$1,206
RH	4296-CO	\$1,015	\$1,038	\$1,038	\$1,180	\$1,267
LH	4296-DO	\$1,015	\$1,038	\$1,038	\$1,180	\$1,267
PAIR	7296-KO	\$1,977	\$2,041	\$2,041	\$2,262	\$2,396



SERIES 380 MEDIUM STILE						
HAND	DESCRIPTION	FINISH CODE / DOOR PRICE				
		#11 CLEAR	#21 BRONZE	#81 WHITE	#2604 POWDER	#2605 POWDER
RH	3696MS-CO	\$1,036	\$1,068	\$1,068	\$1,216	\$1,308
LH	3696MS-DO	\$1,036	\$1,068	\$1,068	\$1,216	\$1,308
RH	4296MS-CO	\$1,091	\$1,113	\$1,113	\$1,279	\$1,375
LH	4296MS-DO	\$1,091	\$1,113	\$1,113	\$1,279	\$1,375
PAIR	7296MS-KO	\$2,154	\$2,216	\$2,216	\$2,504	\$2,659



SERIES 500 WIDE STILE						
HAND	DESCRIPTION	FINISH CODE / DOOR PRICE				
		#11 CLEAR	#21 BRONZE	#81 WHITE	#2604 POWDER	#2605 POWDER
RH	3696WS-CO	\$1,112	\$1,143	\$1,143	\$1,310	\$1,407
LH	3696WS-DO	\$1,112	\$1,143	\$1,143	\$1,310	\$1,407
RH	4296WS-CO	\$1,167	\$1,188	\$1,188	\$1,373	\$1,476
LH	4296WS-DO	\$1,167	\$1,188	\$1,188	\$1,373	\$1,476
PAIR	7296WS-KO	\$2,271	\$2,335	\$2,335	\$2,660	\$2,825

Note: Add "DM001" to substitute DG101 Glass Stops used for 1" Insulated Glass.

**Offset Pivot CVR Panic Frame Package Includes**

- 1 3/4" or 2" x 4 1/2" Open Back Frame
- Snap-in DS200 Jamb Door Stop w/pile
- 1/2" x 4" Threshold – Mill Finish
- Applied DS202 Header Door stop

- Bottom Frame Pivots
- Prep for Lock Strike
- Prepped for DH100 Top Pivot
- Prep for Intermediate Pivots

- Prep for Top & Bottom Flush Bolts (pair)
- Prep for COC
- Frame assembly fastener package
- Threshold Clips

Note: All Hardware on Powder coat products is furnished in a standard clear finish.

Note: Standard Frame Height for Transom Frames = 10'-5 1/2".

Order Number Example: 3696-DO-FT2 (Size) - (Hand or Pair) - (Type)

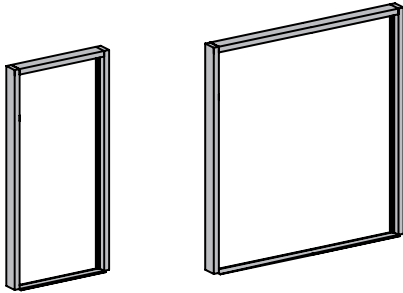

FL200 DOOR FRAME (Non-Transom)						
HAND	DESCRIPTION	FINISH CODE / FRAME PRICE				
		#11 CLEAR	#21 BRONZE	#81 WHITE	#2604 POWDER	#2605 POWDER
RH	3696-CO-F2	\$587	\$596	\$596	\$717	\$763
LH	3696-DO-F2	\$587	\$596	\$596	\$717	\$763
RH	4296-CO-F2	\$595	\$606	\$606	\$732	\$780
LH	4296-DO-F2	\$595	\$606	\$606	\$732	\$780
PAIR	7296-KO-F2	\$721	\$731	\$731	\$884	\$938

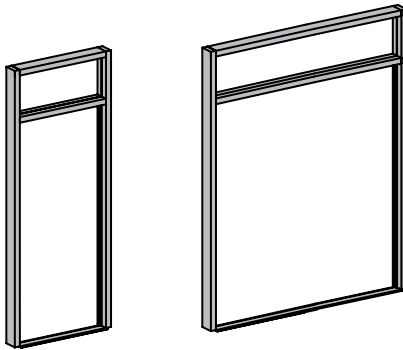

FL200 DOOR FRAME WITH TRANSOM						
HAND	DESCRIPTION	FINISH CODE / FRAME PRICE				
		#11 CLEAR	#21 BRONZE	#81 WHITE	#2604 POWDER	#2605 POWDER
RH	3696-CO-FT2	\$776	\$792	\$792	\$959	\$1,021
LH	3696-DO-FT2	\$776	\$792	\$792	\$959	\$1,021
RH	4296-CO-FT2	\$793	\$809	\$809	\$986	\$1,052
LH	4296-DO-FT2	\$793	\$809	\$809	\$986	\$1,052
PAIR	7296-KO-FT2	\$959	\$979	\$979	\$1,207	\$1,288

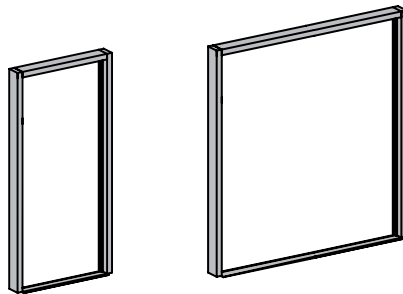

FL300 DOOR FRAME (Non-Transom)						
HAND	DESCRIPTION	FINISH CODE / FRAME PRICE				
		#11 CLEAR	#21 BRONZE	#81 WHITE	#2604 POWDER	#2605 POWDER
RH	3696-CO-F3	\$607	\$617	\$617	\$742	\$790
LH	3696-DO-F3	\$607	\$617	\$617	\$742	\$790
RH	4296-CO-F3	\$616	\$627	\$627	\$759	\$807
LH	4296-DO-F3	\$616	\$627	\$627	\$759	\$807
PAIR	7296-KO-F3	\$751	\$763	\$763	\$920	\$975

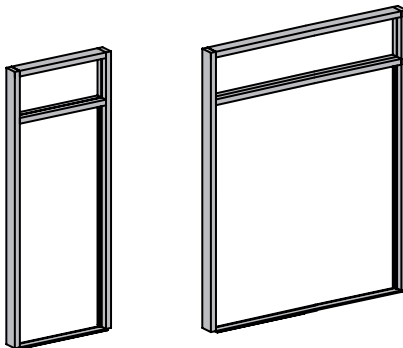

FL300 DOOR FRAME WITH TRANSOM						
HAND	DESCRIPTION	FINISH CODE / FRAME PRICE				
		#11 CLEAR	#21 BRONZE	#81 WHITE	#2604 POWDER	#2605 POWDER
RH	3696-CO-FT3	\$843	\$863	\$863	\$1,056	\$1,127
LH	3696-DO-FT3	\$843	\$863	\$863	\$1,056	\$1,127
RH	4296-CO-FT3	\$861	\$880	\$880	\$1,082	\$1,157
LH	4296-DO-FT3	\$861	\$880	\$880	\$1,082	\$1,157
PAIR	7296-KO-FT3	\$1,031	\$1,053	\$1,053	\$1,319	\$1,411

# Entrances

## Standard Doors • Offset Pivot/Panic/Offset Arm

### Offset Pivot – CVR Panic – Offset Arm Door Package Includes

- Traditional 1" rd Pull/Push Hardware
- Glass Stops for ¼" Glazing
- Top & Bottom Door Pivots
- Slide Channel installed with Offset Arm
- DH3692 CVR Touch Bar Panic(s)
- Keyed Cylinder Exterior - Single or Active Leaf

*Note: Reference Hardware Section of the Price Catalog for Door Closers and Loose Hardware Items not included in Standard Entrance section.*

*Note: All Hardware on Powder coat products is furnished in a standard clear finish.*

*Note: D102 Top Rail on Narrow Stile Doors with offset arm. DH100 Intermediate pivot used as top pivot.*

Order Number Example: **3684MS-DOP** (Size and Series) - (Hand or Pair)



SERIES 213 NARROW STILE						
HAND	DESCRIPTION	FINISH CODE / DOOR PRICE				
		#11 CLEAR	#21 BRONZE	#81 WHITE	#2604 POWDER	#2605 POWDER
RH	3684-COP	\$1,265	\$1,280	\$1,280	\$1,397	\$1,476
LH	3684-DOP	\$1,265	\$1,280	\$1,280	\$1,397	\$1,476
RH	4284-COP	\$1,294	\$1,310	\$1,310	\$1,435	\$1,516
LH	4284-DOP	\$1,294	\$1,310	\$1,310	\$1,435	\$1,516
PAIR	7284-KOP	\$2,576	\$2,608	\$2,608	\$2,817	\$2,940



SERIES 380 MEDIUM STILE						
HAND	DESCRIPTION	FINISH CODE / DOOR PRICE				
		#11 CLEAR	#21 BRONZE	#81 WHITE	#2604 POWDER	#2605 POWDER
RH	3684MS-COP	\$1,329	\$1,343	\$1,343	\$1,481	\$1,567
LH	3684MS-DOP	\$1,329	\$1,343	\$1,343	\$1,481	\$1,567
RH	4284MS-COP	\$1,363	\$1,378	\$1,378	\$1,524	\$1,614
LH	4284MS-DOP	\$1,363	\$1,378	\$1,378	\$1,524	\$1,614
PAIR	7284MS-KOP	\$2,735	\$2,767	\$2,767	\$3,035	\$3,178



SERIES 500 WIDE STILE						
HAND	DESCRIPTION	FINISH CODE / DOOR PRICE				
		#11 CLEAR	#21 BRONZE	#81 WHITE	#2604 POWDER	#2605 POWDER
RH	3684WS-COP	\$1,399	\$1,414	\$1,414	\$1,569	\$1,678
LH	3684WS-DOP	\$1,399	\$1,414	\$1,414	\$1,569	\$1,678
RH	4284WS-COP	\$1,433	\$1,448	\$1,448	\$1,610	\$1,704
LH	4284WS-DOP	\$1,433	\$1,448	\$1,448	\$1,610	\$1,704
PAIR	7284WS-KOP	\$2,842	\$2,875	\$2,875	\$3,174	\$3,325

*Note: Add "DM001" to substitute DG101 Glass Stops used for 1" Insulated Glass.*



**Offset Pivot – CVR Panic – Offset Arm Frame Package Includes**

- 1¼" or 2" x 4½" Open Back Frame
- Snap-in DS200 Jamb Door Stop w/pile
- Applied DS202 Header Door stop
- ½" x 4" Threshold – Mill Finish
- Bottom Frame Pivots
- Prepped for DH100 Top Pivot
- Prep for DH3692 CVR Panic(s)
- Threshold Clips
- Prep for Intermediate Pivots
- Prep for COC
- Frame assembly fastener package

Note: All Hardware on Powder coat products is furnished in a standard clear finish.

Note: Standard Frame Height for Transom Frames = 10'-5 ½".

Order Number Example: **3684-DOP-FT2** (Size) - (Hand or Pair) - (Type)

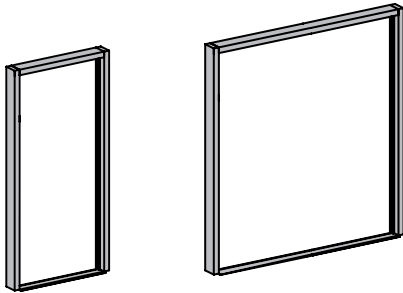

FL200 DOOR FRAME (Non-Transom)						
HAND	DESCRIPTION	FINISH CODE / FRAME PRICE				
		#11 CLEAR	#21 BRONZE	#81 WHITE	#2604 POWDER	#2605 POWDER
RH	3684-COP-F2	\$556	\$565	\$565	\$674	\$714
LH	3684-DOP-F2	\$556	\$565	\$565	\$674	\$714
RH	4284-COP-F2	\$565	\$575	\$575	\$688	\$730
LH	4284-DOP-F2	\$565	\$575	\$575	\$688	\$730
PAIR	7284-KOP-F2	\$685	\$693	\$693	\$833	\$882

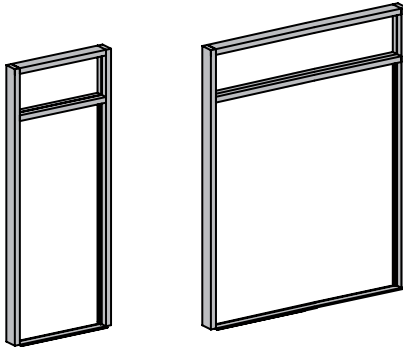

FL200 DOOR FRAME WITH TRANSOM						
HAND	DESCRIPTION	FINISH CODE / FRAME PRICE				
		#11 CLEAR	#21 BRONZE	#81 WHITE	#2604 POWDER	#2605 POWDER
RH	3684-COP-FT2	\$768	\$784	\$784	\$945	\$1,005
LH	3684-DOP-FT2	\$768	\$784	\$784	\$945	\$1,005
RH	4284-COP-FT2	\$784	\$801	\$801	\$973	\$1,038
LH	4284-DOP-FT2	\$784	\$801	\$801	\$973	\$1,038
PAIR	7284-KOP-FT2	\$945	\$964	\$964	\$1,186	\$1,266

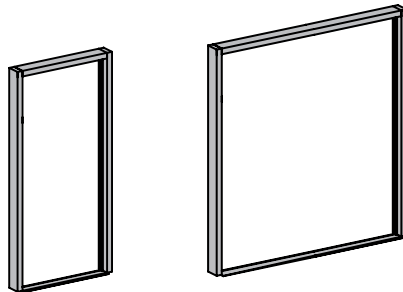

FL300 DOOR FRAME (Non-Transom)						
HAND	DESCRIPTION	FINISH CODE / FRAME PRICE				
		#11 CLEAR	#21 BRONZE	#81 WHITE	#2604 POWDER	#2605 POWDER
RH	3684-COP-F3	\$576	\$585	\$585	\$696	\$738
LH	3684-DOP-F3	\$576	\$585	\$585	\$696	\$738
RH	4284-COP-F3	\$587	\$596	\$596	\$713	\$756
LH	4284-DOP-F3	\$587	\$596	\$596	\$713	\$756
PAIR	7284-KOP-F3	\$713	\$723	\$723	\$867	\$919

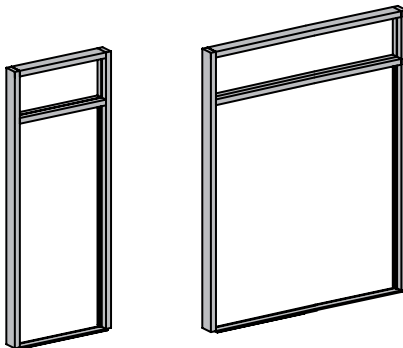

FL300 DOOR FRAME WITH TRANSOM						
HAND	DESCRIPTION	FINISH CODE / FRAME PRICE				
		#11 CLEAR	#21 BRONZE	#81 WHITE	#2604 POWDER	#2605 POWDER
RH	3684-COP-FT3	\$847	\$868	\$868	\$1,067	\$1,141
LH	3684-DOP-FT3	\$847	\$868	\$868	\$1,067	\$1,141
RH	4284-COP-FT3	\$866	\$886	\$886	\$1,095	\$1,172
LH	4284-DOP-FT3	\$866	\$886	\$886	\$1,095	\$1,172
PAIR	7284-KOP-FT3	\$1,029	\$1,052	\$1,052	\$1,325	\$1,420

# Entrances

## Standard Doors • Offset Pivot/Panic/Offset Arm

### Offset Pivot – CVR Panic – Offset Arm Door Package Includes

- Traditional 1" rd Pull/Push Hardware
- Glass Stops for ¼" Glazing
- Top, Bottom & Intermediate Door Pivots
- Slide Channel installed with Offset Arm
- DH3692 CVR Touch Bar Panic(s)
- Keyed Cylinder Exterior - Single or Active Leaf

Note: Reference Hardware Section of the Price Catalog for Door Closers and Loose Hardware Items not included in Standard Entrance section.

Note: All Hardware on Powder coat products is furnished in a standard clear finish.

Note: D102 Top Rail on Narrow Stile Doors with offset arm. DH100 Intermediate pivot used as top pivot.

Order Number Example: 3696MS-DOP (Size and Series) - (Hand or Pair)



SERIES 213 NARROW STILE						
HAND	DESCRIPTION	FINISH CODE / DOOR PRICE				
		#11 CLEAR	#21 BRONZE	#81 WHITE	#2604 POWDER	#2605 POWDER
RH	3696-COP	\$1,365	\$1,381	\$1,381	\$1,512	\$1,596
LH	3696-DOP	\$1,365	\$1,381	\$1,381	\$1,512	\$1,596
RH	4296-COP	\$1,398	\$1,414	\$1,414	\$1,554	\$1,642
LH	4296-DOP	\$1,398	\$1,414	\$1,414	\$1,554	\$1,642
PAIR	7296-KOP	\$2,279	\$2,816	\$2,816	\$3,049	\$3,184



SERIES 380 MEDIUM STILE						
HAND	DESCRIPTION	FINISH CODE / DOOR PRICE				
		#11 CLEAR	#21 BRONZE	#81 WHITE	#2604 POWDER	#2605 POWDER
RH	3696MS-COP	\$1,437	\$1,452	\$1,452	\$1,607	\$1,698
LH	3696MS-DOP	\$1,437	\$1,452	\$1,452	\$1,607	\$1,698
RH	4296MS-COP	\$1,472	\$1,490	\$1,490	\$1,655	\$1,750
LH	4296MS-DOP	\$1,472	\$1,490	\$1,490	\$1,655	\$1,750
PAIR	7296MS-KOP	\$2,953	\$2,989	\$2,989	\$3,288	\$3,443



SERIES 500 WIDE STILE						
HAND	DESCRIPTION	FINISH CODE / DOOR PRICE				
		#11 CLEAR	#21 BRONZE	#81 WHITE	#2604 POWDER	#2605 POWDER
RH	3696WS-COP	\$1,512	\$1,527	\$1,527	\$1,701	\$1,798
LH	3696WS-DOP	\$1,512	\$1,527	\$1,527	\$1,701	\$1,798
RH	4296WS-COP	\$1,547	\$1,566	\$1,566	\$1,748	\$1,850
LH	4296WS-DOP	\$1,547	\$1,566	\$1,566	\$1,748	\$1,850
PAIR	7296WS-KOP	\$3,071	\$3,107	\$3,107	\$3,442	\$3,609

Note: Add "DM001" to substitute DG101 Glass Stops used for 1" Insulated Glass.



**Offset Pivot – CVR Panic – Offset Arm Frame Package Includes**

- 1 3/4" or 2" x 4 1/2" Open Back Frame
- Snap-in DS200 Jamb Door Stop w/pile
- Applied DS202 Header Door stop
- 1/2" x 4" Threshold – Mill Finish
- Threshold Clips
- Prepped for DH100 Top Pivot
- Bottom Frame Pivots
- Prep for DH3692 CVR Panic(s)
- Prep for Intermediate Pivots
- Prep for COC
- Frame assembly fastener package

Note: All Hardware on Powder coat products is furnished in a standard clear finish.

Note: Standard Frame Height for Transom Frames = 10'-5 1/2".

Order Number Example: 3696-DOP-FT2 (Size) - (Hand or Pair) - (Type)

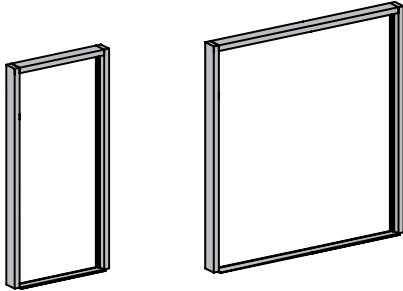

FL200 DOOR FRAME (Non-Transom)						
HAND	DESCRIPTION	FINISH CODE / FRAME PRICE				
		#11 CLEAR	#21 BRONZE	#81 WHITE	#2604 POWDER	#2605 POWDER
RH	3696-COP-F2	\$605	\$615	\$615	\$737	\$781
LH	3696-DOP-F2	\$605	\$615	\$615	\$737	\$781
RH	4296-COP-F2	\$614	\$624	\$624	\$751	\$798
LH	4296-DOP-F2	\$614	\$624	\$624	\$751	\$798
PAIR	7296-KOP-F2	\$740	\$749	\$749	\$902	\$956

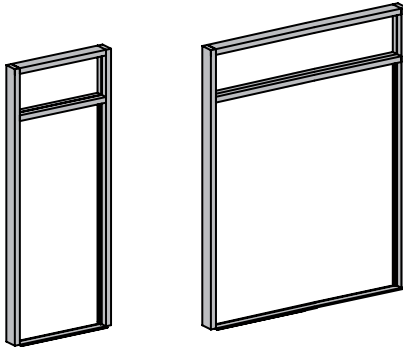

FL200 DOOR FRAME WITH TRANSOM						
HAND	DESCRIPTION	FINISH CODE / FRAME PRICE				
		#11 CLEAR	#21 BRONZE	#81 WHITE	#2604 POWDER	#2605 POWDER
RH	3696-COP-FT2	\$796	\$811	\$811	\$977	\$1,040
LH	3696-DOP-FT2	\$796	\$811	\$811	\$977	\$1,040
RH	4296-COP-FT2	\$812	\$827	\$827	\$1,005	\$1,071
LH	4296-DOP-FT2	\$812	\$827	\$827	\$1,005	\$1,071
PAIR	7296-KOP-FT2	\$978	\$997	\$997	\$1,225	\$1,306

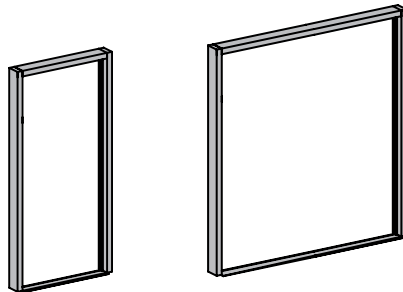

FL300 DOOR FRAME (Non-Transom)						
HAND	DESCRIPTION	FINISH CODE / FRAME PRICE				
		#11 CLEAR	#21 BRONZE	#81 WHITE	#2604 POWDER	#2605 POWDER
RH	3696-COP-F3	\$625	\$635	\$635	\$762	\$808
LH	3696-DOP-F3	\$625	\$635	\$635	\$762	\$808
RH	4296-COP-F3	\$635	\$646	\$646	\$777	\$826
LH	4296-DOP-F3	\$635	\$646	\$646	\$777	\$826
PAIR	7296-KOP-F3	\$769	\$781	\$781	\$937	\$993

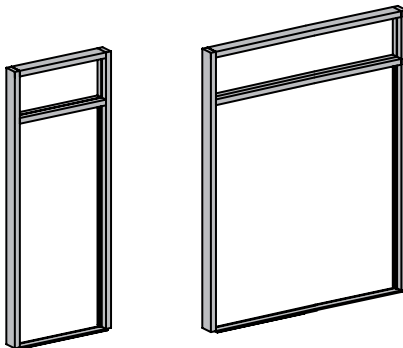

FL300 DOOR FRAME WITH TRANSOM						
HAND	DESCRIPTION	FINISH CODE / FRAME PRICE				
		#11 CLEAR	#21 BRONZE	#81 WHITE	#2604 POWDER	#2605 POWDER
RH	3696-COP-FT3	\$863	\$882	\$882	\$1,074	\$1,145
LH	3696-DOP-FT3	\$863	\$882	\$882	\$1,074	\$1,145
RH	4296-COP-FT3	\$880	\$900	\$900	\$1,102	\$1,176
LH	4296-DOP-FT3	\$880	\$900	\$900	\$1,102	\$1,176
PAIR	7296-KOP-FT3	\$1,049	\$1,073	\$1,073	\$1,337	\$1,430

# Entrances

## Standard Doors • Butt Hinge



### Butt Hinge Door Package Includes

- Traditional 1" rd Pull/Push Hardware
- Glass Stops for ¼" Glazing
- One Pair 4½" x 4" Butt Hinges
- MS Hook Bolt - Single or Active Leaf
- Top & Bottom Flush Bolts Inactive Leaf
- Keyed Cylinder Exterior
- Thumb Turn Interior

Note: Reference Hardware Section of the Price Catalog for Door Closers and Loose Hardware Items not included in Standard Entrance section.

Note: All Hardware on Powder coat products is furnished in a standard clear finish.

Order Number Example: **3684MS-B** (Size and Series) - (Hand or Pair)



SERIES 213 NARROW STILE						
HAND	DESCRIPTION	FINISH CODE / DOOR PRICE				
		#11 CLEAR	#21 BRONZE	#81 WHITE	#2604 POWDER	#2605 POWDER
RH	3684-A	\$719	\$748	\$748	\$857	\$934
LH	3684-B	\$719	\$748	\$748	\$857	\$934
RH	4284-A	\$761	\$785	\$785	\$907	\$987
LH	4284-B	\$761	\$785	\$785	\$907	\$987
PAIR	7284-J	\$1,468	\$1,532	\$1,532	\$1,723	\$1,845



SERIES 380 MEDIUM STILE						
HAND	DESCRIPTION	FINISH CODE / DOOR PRICE				
		#11 CLEAR	#21 BRONZE	#81 WHITE	#2604 POWDER	#2605 POWDER
RH	3684MS-A	\$793	\$823	\$823	\$956	\$1,042
LH	3684MS-B	\$793	\$823	\$823	\$956	\$1,042
RH	4284MS-A	\$840	\$865	\$865	\$1,015	\$1,105
LH	4284MS-B	\$840	\$865	\$865	\$1,015	\$1,105
PAIR	7284MS-J	\$1,619	\$1,710	\$1,710	\$1,940	\$2,040



SERIES 500 WIDE STILE						
HAND	DESCRIPTION	FINISH CODE / DOOR PRICE				
		#11 CLEAR	#21 BRONZE	#81 WHITE	#2604 POWDER	#2605 POWDER
RH	3684WS-A	\$846	\$877	\$877	\$1,025	\$1,116
LH	3684WS-B	\$846	\$877	\$877	\$1,025	\$1,116
RH	4284WS-A	\$895	\$918	\$918	\$1,083	\$1,178
LH	4284WS-B	\$895	\$918	\$918	\$1,083	\$1,178
PAIR	7284WS-J	\$1,725	\$1,791	\$1,791	\$2,079	\$2,230

Note: Add "DM001" to substitute DG101 Glass Stops used for 1" Insulated Glass.

**Butt Hinge Frame Package Includes**

- 1¾" or 2" x 4½" Open Back Frame
- Snap-in DS200 Door Stop w/pile
- ½" x 4" Threshold – Mill Finish
- Threshold Clips
- Prep for Lock Strike
- Prep for One Pair 4½" x 4" Butt Hinges
- Prep for Top & Bottom Flush Bolts (pair)
- Frame assembly fastener package

Note: All Hardware on Powder coat products is furnished in a standard clear finish.

Note: Standard Frame Height for Transom Frames = 10'-5 ½".

Order Number Example: 3684-B-FT2 (Size) - (Hand or Pair) - (Type)

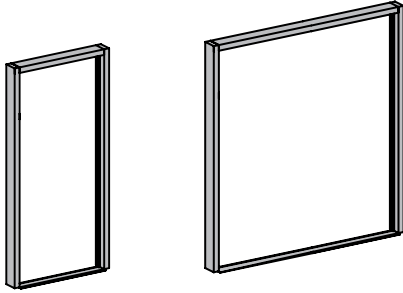

FL200 DOOR FRAME (Non-Transom)						
HAND	DESCRIPTION	FINISH CODE / FRAME PRICE				
		#11 CLEAR	#21 BRONZE	#81 WHITE	#2604 POWDER	#2605 POWDER
RH	3684-A-F2	\$425	\$436	\$436	\$534	\$576
LH	3684-B-F2	\$425	\$436	\$436	\$534	\$576
RH	4284-A-F2	\$436	\$445	\$445	\$546	\$588
LH	4284-B-F2	\$436	\$445	\$445	\$546	\$588
PAIR	7284-J-F2	\$506	\$516	\$516	\$634	\$682

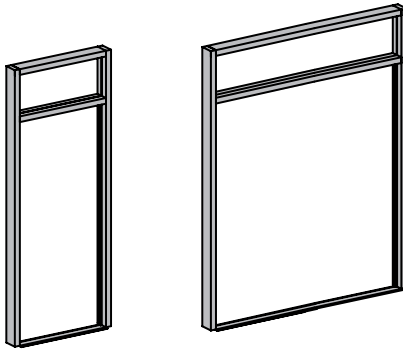

FL200 DOOR FRAME WITH TRANSOM						
HAND	DESCRIPTION	FINISH CODE / FRAME PRICE				
		#11 CLEAR	#21 BRONZE	#81 WHITE	#2604 POWDER	#2605 POWDER
RH	3684-A-FT2	\$588	\$604	\$604	\$732	\$787
LH	3684-B-FT2	\$588	\$604	\$604	\$732	\$787
RH	4284-A-FT2	\$602	\$618	\$618	\$753	\$809
LH	4284-B-FT2	\$602	\$618	\$618	\$753	\$809
PAIR	7284-J-FT2	\$705	\$724	\$724	\$896	\$963

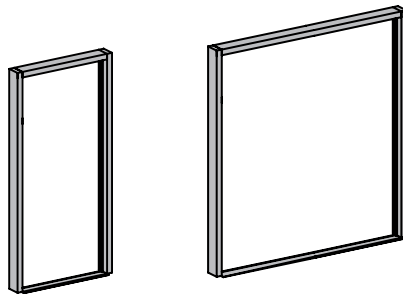

FL300 DOOR FRAME (Non-Transom)						
HAND	DESCRIPTION	FINISH CODE / FRAME PRICE				
		#11 CLEAR	#21 BRONZE	#81 WHITE	#2604 POWDER	#2605 POWDER
RH	3684-A-F3	\$436	\$447	\$447	\$545	\$587
LH	3684-B-F3	\$436	\$447	\$447	\$545	\$587
RH	4284-A-F3	\$446	\$456	\$456	\$560	\$602
LH	4284-B-F3	\$446	\$456	\$456	\$560	\$602
PAIR	7284-J-F3	\$521	\$533	\$533	\$651	\$700

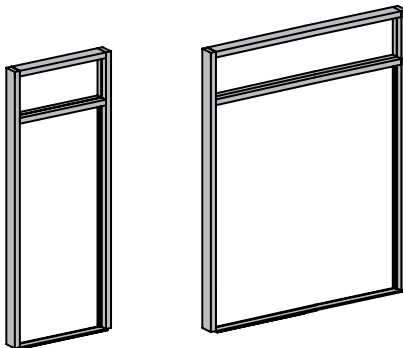

FL300 DOOR FRAME WITH TRANSOM						
HAND	DESCRIPTION	FINISH CODE / FRAME PRICE				
		#11 CLEAR	#21 BRONZE	#81 WHITE	#2604 POWDER	#2605 POWDER
RH	3684-A-FT3	\$635	\$657	\$657	\$829	\$898
LH	3684-B-FT3	\$635	\$657	\$657	\$829	\$898
RH	4284-A-FT3	\$650	\$671	\$671	\$850	\$920
LH	4284-B-FT3	\$650	\$671	\$671	\$850	\$920
PAIR	7284-J-FT3	\$748	\$773	\$773	\$993	\$1,074

# Entrances

## Standard Doors • Butt Hinge



### Butt Hinge Door Package Includes

- Traditional 1" rd Pull/Push Hardware
- Glass Stops for ¼" Glazing
- 1½ Pair 4½" x 4" Butt Hinges
- MS Hook Bolt - Single or Active Leaf
- Top & Bottom Flush Bolts Inactive Leaf
- Keyed Cylinder Exterior
- Thumb Turn Interior

Note: Reference Hardware Section of the Price Catalog for Door Closers and Loose Hardware Items not included in Standard Entrance section.  
 Note: All Hardware on Powder coat products is furnished in a standard clear finish.

Order Number Example: 3696MS-A (Size and Series) - (Hand or Pair)



SERIES 213 NARROW STILE						
HAND	DESCRIPTION	FINISH CODE / DOOR PRICE				
		#11 CLEAR	#21 BRONZE	#81 WHITE	#2604 POWDER	#2605 POWDER
RH	3696-A	\$780	\$813	\$813	\$936	\$1,019
LH	3696-B	\$780	\$813	\$813	\$936	\$1,019
RH	4296-A	\$829	\$854	\$854	\$992	\$1,078
LH	4296-B	\$829	\$854	\$854	\$992	\$1,078
PAIR	7296-J	\$1,601	\$1,668	\$1,668	\$1,884	\$2,015



SERIES 380 MEDIUM STILE						
HAND	DESCRIPTION	FINISH CODE / DOOR PRICE				
		#11 CLEAR	#21 BRONZE	#81 WHITE	#2604 POWDER	#2605 POWDER
RH	3696MS-A	\$864	\$896	\$896	\$1,046	\$1,138
LH	3696MS-B	\$864	\$896	\$896	\$1,046	\$1,138
RH	4296MS-A	\$916	\$942	\$942	\$1,109	\$1,204
LH	4296MS-B	\$916	\$942	\$942	\$1,109	\$1,204
PAIR	7296MS-J	\$1,764	\$1,833	\$1,833	\$2,124	\$2,278



SERIES 500 WIDE STILE						
HAND	DESCRIPTION	FINISH CODE / DOOR PRICE				
		#11 CLEAR	#21 BRONZE	#81 WHITE	#2604 POWDER	#2605 POWDER
RH	3696WS-A	\$922	\$956	\$956	\$1,124	\$1,221
LH	3696WS-B	\$922	\$956	\$956	\$1,124	\$1,221
RH	4296WS-A	\$976	\$1,002	\$1,002	\$1,187	\$1,290
LH	4296WS-B	\$976	\$1,002	\$1,002	\$1,187	\$1,290
PAIR	7296WS-J	\$1,883	\$1,951	\$1,951	\$2,279	\$2,445

Note: Add "DM001" to substitute DG101 Glass Stops used for 1" Insulated Glass.

### Butt Hinge Frame Package Includes

- 1½" or 2" x 4½" Open Back Frame
- Snap-in DS200 Door Stop w/pile
- ½" x 4" Threshold – Mill Finish
- Threshold Clips
- Prep for Lock Strike
- Prep for 1½ Pair 4½" x 4" Butt Hinges
- Prep for Top & Bottom Flush Bolts (pair)
- Frame assembly fastener package

Note: All Hardware on Powder coat products is furnished in a standard clear finish.

Note: Standard Frame Height for Transom Frames = 10'-5 ½".

Order Number Example: 3696-A-FT2 (Size) - (Hand or Pair) - (Type)

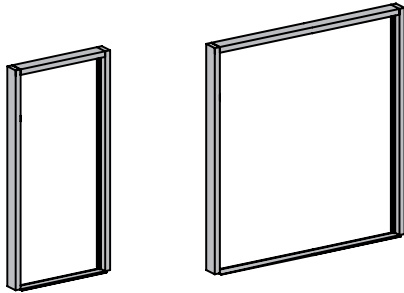

FL200 DOOR FRAME (Non-Transom)						
HAND	DESCRIPTION	FINISH CODE / FRAME PRICE				
		#11 CLEAR	#21 BRONZE	#81 WHITE	#2604 POWDER	#2605 POWDER
RH	3696-A-F2	\$469	\$481	\$481	\$592	\$636
LH	3696-B-F2	\$469	\$481	\$481	\$592	\$636
RH	4296-A-F2	\$479	\$491	\$491	\$605	\$651
LH	4296-B-F2	\$479	\$491	\$491	\$605	\$651
PAIR	7296-J-F2	\$553	\$568	\$568	\$704	\$756

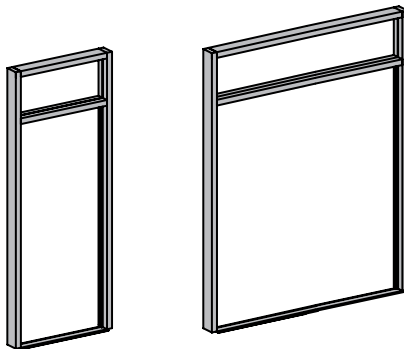

FL200 DOOR FRAME WITH TRANSOM						
HAND	DESCRIPTION	FINISH CODE / FRAME PRICE				
		#11 CLEAR	#21 BRONZE	#81 WHITE	#2604 POWDER	#2605 POWDER
RH	3696-A-FT2	\$611	\$627	\$627	\$760	\$816
LH	3696-B-FT2	\$611	\$627	\$627	\$760	\$816
RH	4296-A-FT2	\$625	\$641	\$641	\$781	\$840
LH	4296-B-FT2	\$625	\$641	\$641	\$781	\$840
PAIR	7296-J-FT2	\$733	\$752	\$752	\$921	\$990

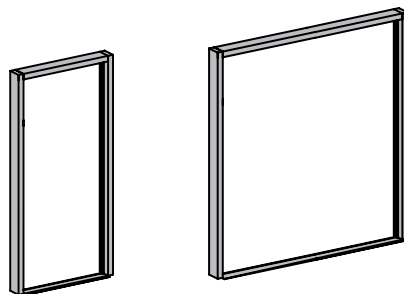

FL300 DOOR FRAME (Non-Transom)						
HAND	DESCRIPTION	FINISH CODE / FRAME PRICE				
		#11 CLEAR	#21 BRONZE	#81 WHITE	#2604 POWDER	#2605 POWDER
RH	3696-A-F3	\$481	\$494	\$494	\$606	\$651
LH	3696-B-F3	\$481	\$494	\$494	\$606	\$651
RH	4296-A-F3	\$490	\$502	\$502	\$620	\$667
LH	4296-B-F3	\$490	\$502	\$502	\$620	\$667
PAIR	7296-J-F3	\$570	\$586	\$586	\$723	\$776

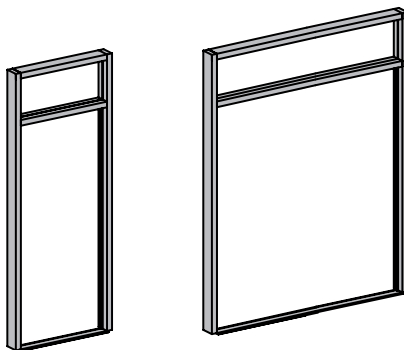

FL300 DOOR FRAME WITH TRANSOM						
HAND	DESCRIPTION	FINISH CODE / FRAME PRICE				
		#11 CLEAR	#21 BRONZE	#81 WHITE	#2604 POWDER	#2605 POWDER
RH	3696-A-FT3	\$646	\$665	\$665	\$832	\$898
LH	3696-B-FT3	\$646	\$665	\$665	\$832	\$898
RH	4296-A-FT3	\$660	\$679	\$679	\$851	\$920
LH	4296-B-FT3	\$660	\$679	\$679	\$851	\$920
PAIR	7296-J-FT3	\$763	\$787	\$787	\$990	\$1,070

# Entrances

## Standard Doors • Butt Hinge/Panic



### Butt Hinge CVR Panic Door Package Includes

- Traditional 1" rd Pull/Push Hardware
- Glass Stops for ¼" Glazing
- One Pair 4½" x 4" Butt Hinges
- DH3692 CVR Touch Bar Panic(s)
- Keyed Cylinder Exterior - Single or Active Leaf

Note: Reference Hardware Section of the Price Catalog for Door Closers and Loose Hardware Items not included in Standard Entrance section.  
Note: All Hardware on Powder coat products is furnished in a standard clear finish.

Order Number Example: **3684MS-BP** (Size and Series) - (Hand or Pair)



SERIES 213 NARROW STILE						
HAND	DESCRIPTION	FINISH CODE / DOOR PRICE				
		#11 CLEAR	#21 BRONZE	#81 WHITE	#2604 POWDER	#2605 POWDER
RH	3684-AP	\$1,116	\$1,133	\$1,133	\$1,247	\$1,325
LH	3684-BP	\$1,116	\$1,133	\$1,133	\$1,247	\$1,325
RH	4284-AP	\$1,143	\$1,162	\$1,162	\$1,272	\$1,352
LH	4284-BP	\$1,143	\$1,162	\$1,162	\$1,272	\$1,352
PAIR	7284-JP	\$2,270	\$2,307	\$2,307	\$2,510	\$2,632



SERIES 380 MEDIUM STILE						
HAND	DESCRIPTION	FINISH CODE / DOOR PRICE				
		#11 CLEAR	#21 BRONZE	#81 WHITE	#2604 POWDER	#2605 POWDER
RH	3684MS-AP	\$1,190	\$1,208	\$1,208	\$1,347	\$1,432
LH	3684MS-BP	\$1,190	\$1,208	\$1,208	\$1,347	\$1,432
RH	4284MS-AP	\$1,224	\$1,242	\$1,242	\$1,390	\$1,479
LH	4284MS-BP	\$1,224	\$1,242	\$1,242	\$1,390	\$1,479
PAIR	7284MS-JP	\$2,419	\$2,490	\$2,490	\$2,681	\$2,781



SERIES 500 WIDE STILE						
HAND	DESCRIPTION	FINISH CODE / DOOR PRICE				
		#11 CLEAR	#21 BRONZE	#81 WHITE	#2604 POWDER	#2605 POWDER
RH	3684WS-AP	\$1,245	\$1,261	\$1,261	\$1,415	\$1,507
LH	3684WS-BP	\$1,245	\$1,261	\$1,261	\$1,415	\$1,507
RH	4284WS-AP	\$1,277	\$1,296	\$1,296	\$1,459	\$1,553
LH	4284WS-BP	\$1,277	\$1,296	\$1,296	\$1,459	\$1,553
PAIR	7284WS-JP	\$2,525	\$2,561	\$2,561	\$2,861	\$3,014

Note: Add "DM001" to substitute DG101 Glass Stops used for 1" Insulated Glass.



**Butt Hinge CVR Panic Frame Package Includes**

- 1 3/4" or 2" x 4 1/2" Open Back Frame
- Snap-in DS200 Door Stop w/pile
- 1/2" x 4" Threshold – Mill Finish
- Threshold Clips
- Prep for One Pair 4 1/2" x 4" Butt Hinges
- Prep for DH3692 CVR Panic(s)
- Frame assembly fastener package

Note: All Hardware on Powder coat products is furnished in a standard clear finish.

Note: Standard Frame Height for Transom Frames = 10'-5 1/2".

Order Number Example: **3684-BP-FT2** (Size) - (Hand or Pair) - (Type)

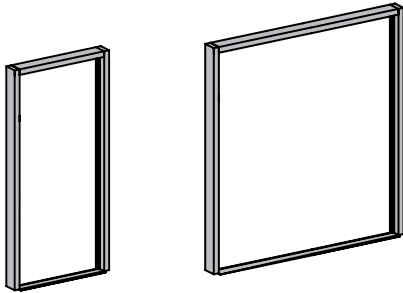

FL200 DOOR FRAME (Non-Transom)						
HAND	DESCRIPTION	FINISH CODE / FRAME PRICE				
		#11 CLEAR	#21 BRONZE	#81 WHITE	#2604 POWDER	#2605 POWDER
RH	3684-AP-F2	\$446	\$456	\$456	\$552	\$592
LH	3684-BP-F2	\$446	\$456	\$456	\$552	\$592
RH	4284-AP-F2	\$454	\$465	\$465	\$566	\$606
LH	4284-BP-F2	\$454	\$465	\$465	\$566	\$606
PAIR	7284-JP-F2	\$524	\$536	\$536	\$660	\$707

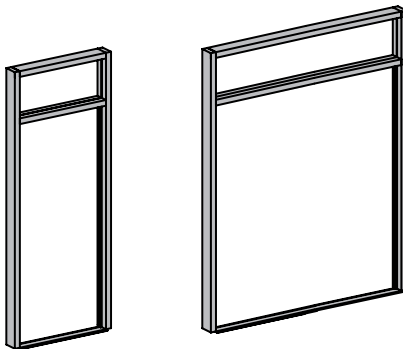

FL200 DOOR FRAME WITH TRANSOM						
HAND	DESCRIPTION	FINISH CODE / FRAME PRICE				
		#11 CLEAR	#21 BRONZE	#81 WHITE	#2604 POWDER	#2605 POWDER
RH	3684-AP-FT2	\$607	\$622	\$622	\$752	\$807
LH	3684-BP-FT2	\$607	\$622	\$622	\$752	\$807
RH	4284-AP-FT2	\$622	\$638	\$638	\$773	\$829
LH	4284-BP-FT2	\$622	\$638	\$638	\$773	\$829
PAIR	7284-JP-FT2	\$724	\$744	\$744	\$907	\$975

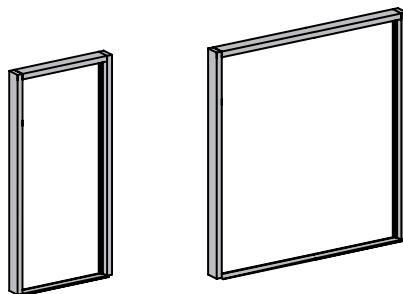

FL300 DOOR FRAME (Non-Transom)						
HAND	DESCRIPTION	FINISH CODE / FRAME PRICE				
		#11 CLEAR	#21 BRONZE	#81 WHITE	#2604 POWDER	#2605 POWDER
RH	3684-AP-F3	\$455	\$466	\$466	\$564	\$605
LH	3684-BP-F3	\$455	\$466	\$466	\$564	\$605
RH	4284-AP-F3	\$465	\$476	\$476	\$578	\$620
LH	4284-BP-F3	\$465	\$476	\$476	\$578	\$620
PAIR	7284-JP-F3	\$541	\$553	\$553	\$676	\$725

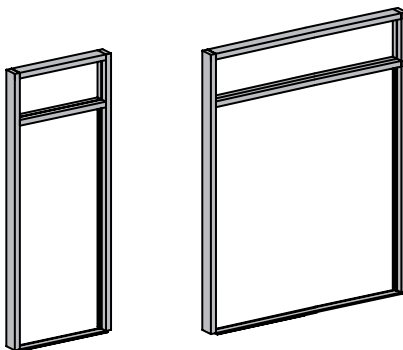

FL300 DOOR FRAME WITH TRANSOM						
HAND	DESCRIPTION	FINISH CODE / FRAME PRICE				
		#11 CLEAR	#21 BRONZE	#81 WHITE	#2604 POWDER	#2605 POWDER
RH	3684-AP-FT3	\$656	\$675	\$675	\$849	\$916
LH	3684-BP-FT3	\$656	\$675	\$675	\$849	\$916
RH	4284-AP-FT3	\$668	\$689	\$689	\$870	\$940
LH	4284-BP-FT3	\$668	\$689	\$689	\$870	\$940
PAIR	7284-JP-FT3	\$768	\$792	\$792	\$1,003	\$1,084

# Entrances

## Standard Doors • Butt Hinge/Panic

**Butt Hinge CVR Panic Door Package Includes**

- Traditional 1" rd Pull/Push Hardware
- Glass Stops for ¼" Glazing
- 1½ Pair 4½" x 4" Butt Hinges
- Keyed Cylinder Exterior - Single or Active Leaf
- DH3692 CVR Touch Bar Panic(s)

*Note: Reference Hardware Section of the Price Catalog for Door Closers and Loose Hardware Items not included in Standard Entrance section.  
Note: All Hardware on Powder coat products is furnished in a standard clear finish.*

Order Number Example: 3696MS-BP (Size and Series) - (Hand or Pair)



SERIES 213 NARROW STILE						
HAND	DESCRIPTION	FINISH CODE / DOOR PRICE				
		#11 CLEAR	#21 BRONZE	#81 WHITE	#2604 POWDER	#2605 POWDER
RH	3696-AP	\$1,179	\$1,198	\$1,198	\$1,327	\$1,410
LH	3696-BP	\$1,179	\$1,198	\$1,198	\$1,327	\$1,410
RH	4296-AP	\$1,211	\$1,230	\$1,230	\$1,366	\$1,452
LH	4296-BP	\$1,211	\$1,230	\$1,230	\$1,366	\$1,452
PAIR	7296-JP	\$2,403	\$2,442	\$2,442	\$2,671	\$2,802



SERIES 380 MEDIUM STILE						
HAND	DESCRIPTION	FINISH CODE / DOOR PRICE				
		#11 CLEAR	#21 BRONZE	#81 WHITE	#2604 POWDER	#2605 POWDER
RH	3696MS-AP	\$1,262	\$1,280	\$1,280	\$1,436	\$1,529
LH	3696MS-BP	\$1,262	\$1,280	\$1,280	\$1,436	\$1,529
RH	4296MS-AP	\$1,300	\$1,318	\$1,318	\$1,484	\$1,579
LH	4296MS-BP	\$1,300	\$1,318	\$1,318	\$1,484	\$1,579
PAIR	7296MS-JP	\$2,564	\$2,605	\$2,605	\$2,906	\$3,062



SERIES 500 WIDE STILE						
HAND	DESCRIPTION	FINISH CODE / DOOR PRICE				
		#11 CLEAR	#21 BRONZE	#81 WHITE	#2604 POWDER	#2605 POWDER
RH	3696WS-AP	\$1,322	\$1,341	\$1,341	\$1,515	\$1,612
LH	3696WS-BP	\$1,322	\$1,341	\$1,341	\$1,515	\$1,612
RH	4296WS-AP	\$1,357	\$1,378	\$1,378	\$1,562	\$1,663
LH	4296WS-BP	\$1,357	\$1,378	\$1,378	\$1,562	\$1,663
PAIR	7296WS-JP	\$2,683	\$2,724	\$2,724	\$3,063	\$3,229

*Note: Add "DM001" to substitute DG101 Glass Stops used for 1" Insulated Glass.*



**Butt Hinge CVR Panic Frame Package Includes**

- 1½" or 2" x 4½" Open Back Frame
- Snap-in DS200 Door Stop w/pile
- ½" x 4" Threshold – Mill Finish
- Threshold Clips
- Prep for 1½ Pair 4½" x 4" Butt Hinges
- Prep for DH3692 CVR Panic(s)
- Frame assembly fastener package

Note: All Hardware on Powder coat products is furnished in a standard clear finish.

Note: Standard Frame Height for Transom Frames = 10'-5 ½".

Order Number Example: **3696-BP-FT2** (Size) - (Hand or Pair) - (Type)

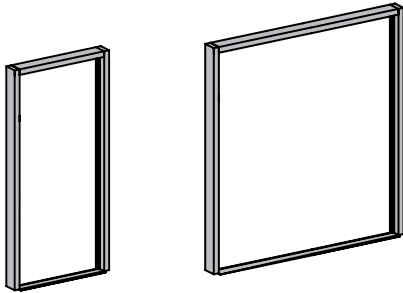

FL200 DOOR FRAME (Non-Transom)						
HAND	DESCRIPTION	FINISH CODE / FRAME PRICE				
		#11 CLEAR	#21 BRONZE	#81 WHITE	#2604 POWDER	#2605 POWDER
RH	3696-AP-F2	\$489	\$501	\$501	\$611	\$655
LH	3696-BP-F2	\$489	\$501	\$501	\$611	\$655
RH	4296-AP-F2	\$497	\$511	\$511	\$625	\$671
LH	4296-BP-F2	\$497	\$511	\$511	\$625	\$671
PAIR	7296-JP-F2	\$574	\$587	\$587	\$723	\$766

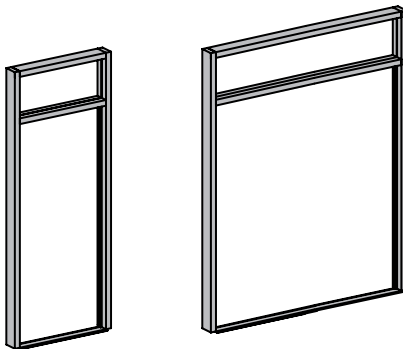

FL200 DOOR FRAME WITH TRANSOM						
HAND	DESCRIPTION	FINISH CODE / FRAME PRICE				
		#11 CLEAR	#21 BRONZE	#81 WHITE	#2604 POWDER	#2605 POWDER
RH	3696-AP-FT2	\$629	\$645	\$645	\$780	\$836
LH	3696-BP-FT2	\$629	\$645	\$645	\$780	\$836
RH	4296-AP-FT2	\$643	\$661	\$661	\$801	\$858
LH	4296-BP-FT2	\$643	\$661	\$661	\$801	\$858
PAIR	7296-JP-FT2	\$751	\$773	\$773	\$940	\$1,008

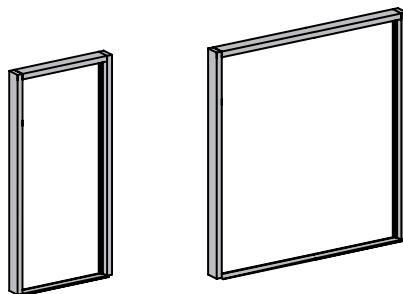

FL300 DOOR FRAME (Non-Transom)						
HAND	DESCRIPTION	FINISH CODE / FRAME PRICE				
		#11 CLEAR	#21 BRONZE	#81 WHITE	#2604 POWDER	#2605 POWDER
RH	3696-AP-F3	\$500	\$512	\$512	\$625	\$671
LH	3696-BP-F3	\$500	\$512	\$512	\$625	\$671
RH	4296-AP-F3	\$510	\$522	\$522	\$639	\$686
LH	4296-BP-F3	\$510	\$522	\$522	\$639	\$686
PAIR	7296-JP-F3	\$591	\$604	\$604	\$742	\$795

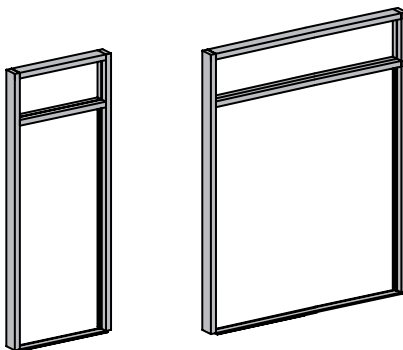

FL300 DOOR FRAME WITH TRANSOM						
HAND	DESCRIPTION	FINISH CODE / FRAME PRICE				
		#11 CLEAR	#21 BRONZE	#81 WHITE	#2604 POWDER	#2605 POWDER
RH	3696-AP-FT3	\$665	\$684	\$684	\$850	\$916
LH	3696-BP-FT3	\$665	\$684	\$684	\$850	\$916
RH	4296-AP-FT3	\$678	\$699	\$699	\$871	\$940
LH	4296-BP-FT3	\$678	\$699	\$699	\$871	\$940
PAIR	7296-JP-FT3	\$782	\$806	\$806	\$1,010	\$1,088

# Entrances

## Standard Doors • Butt Hinge/Offset Arm



### Butt Hinge - Offset Arm Door Package Includes

- Traditional 1" rd Pull/Push Hardware
- Glass Stops for 1/4" Glazing
- One Pair 4 1/2" x 4" Butt Hinges
- Slide Channel installed with Offset Arm
- MS Hook Bolt - Single or Active Leaf
- Top & Bottom Flush Bolts Inactive Leaf
- Keyed Cylinder Exterior
- Thumb Turn Interior

Note: Reference Hardware Section of the Price Catalog for Door Closers and Loose Hardware Items not included in Standard Entrance section.

Note: All Hardware on Powder coat products is furnished in a standard clear finish.

Note: D102 Top Rail on Narrow Stile Doors with offset arm.

Order Number Example: **3684MS-AO** (Size and Series) - (Hand or Pair)



SERIES 213 NARROW STILE						
HAND	DESCRIPTION	FINISH CODE / DOOR PRICE				
		#11 CLEAR	#21 BRONZE	#81 WHITE	#2604 POWDER	#2605 POWDER
RH	3684-AO	\$892	\$921	\$921	\$1,032	\$1,110
LH	3684-BO	\$892	\$921	\$921	\$1,032	\$1,110
RH	4284-AO	\$938	\$960	\$960	\$1,085	\$1,166
LH	4284-BO	\$938	\$960	\$960	\$1,085	\$1,166
PAIR	7284-JO	\$1,818	\$1,879	\$1,879	\$2,081	\$2,243



SERIES 380 MEDIUM STILE						
HAND	DESCRIPTION	FINISH CODE / DOOR PRICE				
		#11 CLEAR	#21 BRONZE	#81 WHITE	#2604 POWDER	#2605 POWDER
RH	3684MS-AO	\$957	\$986	\$986	\$1,116	\$1,201
LH	3684MS-BO	\$957	\$986	\$986	\$1,116	\$1,201
RH	4284MS-AO	\$1,006	\$1,027	\$1,027	\$1,176	\$1,264
LH	4284MS-BO	\$1,006	\$1,038	\$1,017	\$1,176	\$1,264
PAIR	7284MS-JO	\$1,946	\$2,030	\$2,030	\$2,252	\$2,428



SERIES 500 WIDE STILE						
HAND	DESCRIPTION	FINISH CODE / DOOR PRICE				
		#11 CLEAR	#21 BRONZE	#81 WHITE	#2604 POWDER	#2605 POWDER
RH	3684WS-AO	\$1,010	\$1,038	\$1,038	\$1,186	\$1,276
LH	3684WS-BO	\$1,010	\$1,038	\$1,038	\$1,186	\$1,276
RH	4284WS-AO	\$1,057	\$1,081	\$1,081	\$1,244	\$1,339
LH	4284WS-BO	\$1,057	\$1,081	\$1,081	\$1,244	\$1,339
PAIR	7284WS-JO	\$2,053	\$2,114	\$2,114	\$2,399	\$2,551

Note: Add "DM001" to substitute DG101 Glass Stops used for 1" Insulated Glass.

**Butt Hinge - Offset Arm Frame Package Includes**

- 1½" or 2" x 4½" Open Back Frame
- Snap-in DS200 Door Stop w/pile
- ½" x 4" Threshold – Mill Finish
- Threshold Clips
- Prep for Lock Strike
- Prep for One Pair 4½" x 4" Butt Hinges
- Prep for Top & Bottom Flush Bolts (pair)
- Prep for COC
- Frame assembly fastener package
- Applied DS202 Header Door stop

Note: All Hardware on Powder coat products is furnished in a standard clear finish.

Note: Standard Frame Height for Transom Frames = 10'-5 ½".

Order Number Example: **3684-BO-FT2** (Size) - (Hand or Pair) - (Type)

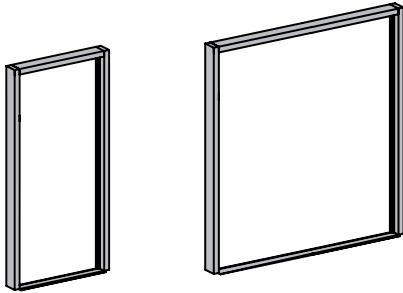

FL200 DOOR FRAME (Non-Transom)						
HAND	DESCRIPTION	FINISH CODE / FRAME PRICE				
		#11 CLEAR	#21 BRONZE	#81 WHITE	#2604 POWDER	#2605 POWDER
RH	3684-AO-F2	\$572	\$580	\$580	\$681	\$721
LH	3684-BO-F2	\$572	\$580	\$580	\$681	\$721
RH	4284-AO-F2	\$581	\$589	\$589	\$696	\$738
LH	4284-BO-F2	\$581	\$589	\$589	\$696	\$738
PAIR	7284-JO-F2	\$710	\$721	\$721	\$851	\$902

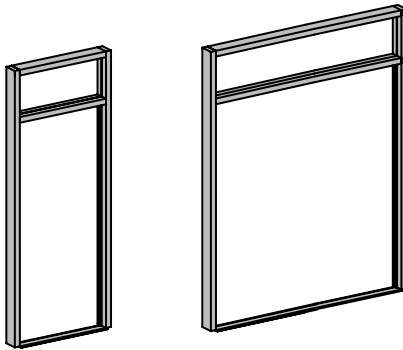

FL200 DOOR FRAME WITH TRANSOM						
HAND	DESCRIPTION	FINISH CODE / FRAME PRICE				
		#11 CLEAR	#21 BRONZE	#81 WHITE	#2604 POWDER	#2605 POWDER
RH	3684-AO-FT2	\$770	\$787	\$787	\$935	\$996
LH	3684-BO-FT2	\$770	\$787	\$787	\$935	\$996
RH	4284-AO-FT2	\$789	\$804	\$804	\$963	\$1,028
LH	4284-BO-FT2	\$789	\$804	\$804	\$963	\$1,028
PAIR	7284-JO-FT2	\$958	\$979	\$979	\$1,187	\$1,267

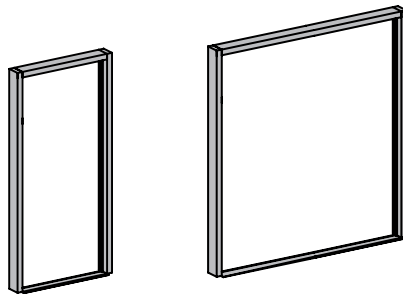

FL300 DOOR FRAME (Non-Transom)						
HAND	DESCRIPTION	FINISH CODE / FRAME PRICE				
		#11 CLEAR	#21 BRONZE	#81 WHITE	#2604 POWDER	#2605 POWDER
RH	3684-AO-F3	\$591	\$600	\$600	\$704	\$746
LH	3684-BO-F3	\$591	\$600	\$600	\$704	\$746
RH	4284-AO-F3	\$601	\$611	\$611	\$720	\$763
LH	4284-BO-F3	\$601	\$611	\$611	\$720	\$763
PAIR	7284-JO-F3	\$741	\$751	\$751	\$886	\$937

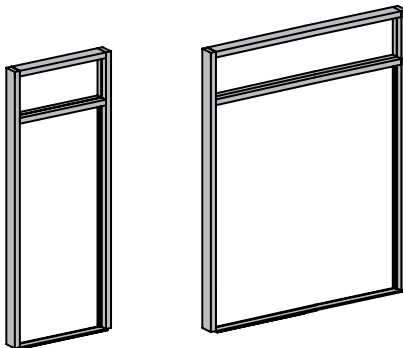

FL300 DOOR FRAME WITH TRANSOM						
HAND	DESCRIPTION	FINISH CODE / FRAME PRICE				
		#11 CLEAR	#21 BRONZE	#81 WHITE	#2604 POWDER	#2605 POWDER
RH	3684-AO-FT3	\$831	\$851	\$851	\$1,046	\$1,120
LH	3684-BO-FT3	\$831	\$851	\$851	\$1,046	\$1,120
RH	4284-AO-FT3	\$847	\$870	\$870	\$1,075	\$1,154
LH	4284-BO-FT3	\$847	\$870	\$870	\$1,075	\$1,154
PAIR	7284-JO-FT3	\$1,024	\$1,048	\$1,048	\$1,308	\$1,402

# Entrances

## Standard Doors • Butt Hinge/Offset Arm

### Butt Hinge - Offset Arm Door Package Includes

- Traditional 1" rd Pull/Push Hardware
- Glass Stops for ¼" Glazing
- 1½ Pair 4½" x 4" Butt Hinges
- Slide Channel installed with Offset Arm
- MS Hook Bolt - Single or Active Leaf
- Top & Bottom Flush Bolts Inactive Leaf
- Keyed Cylinder Exterior
- Thumb Turn Interior

Note: Reference Hardware Section of the Price Catalog for Door Closers and Loose Hardware Items not included in Standard Entrance section.

Note: All Hardware on Powder coat products is furnished in a standard clear finish.

Note: D102 Top Rail on Narrow Stile Doors with offset arm.

Order Number Example: 3696MS-BP (Size and Series) - (Hand or Pair)



SERIES 213 NARROW STILE						
HAND	DESCRIPTION	FINISH CODE / DOOR PRICE				
		#11 CLEAR	#21 BRONZE	#81 WHITE	#2604 POWDER	#2605 POWDER
RH	3696-AO	\$955	\$986	\$986	\$1,111	\$1,196
LH	3696-BO	\$955	\$986	\$986	\$1,111	\$1,196
RH	4296-AO	\$1,006	\$1,028	\$1,028	\$1,170	\$1,257
LH	4296-BO	\$1,006	\$1,028	\$1,028	\$1,170	\$1,257
PAIR	7296-JO	\$1,949	\$2,014	\$2,014	\$2,236	\$2,414



SERIES 380 MEDIUM STILE						
HAND	DESCRIPTION	FINISH CODE / DOOR PRICE				
		#11 CLEAR	#21 BRONZE	#81 WHITE	#2604 POWDER	#2605 POWDER
RH	3696MS-AO	\$1,027	\$1,058	\$1,058	\$1,207	\$1,298
LH	3696MS-BO	\$1,027	\$1,058	\$1,058	\$1,207	\$1,298
RH	4296MS-AO	\$1,080	\$1,103	\$1,103	\$1,270	\$1,365
LH	4296MS-BO	\$1,080	\$1,103	\$1,103	\$1,270	\$1,365
PAIR	7296MS-JO	\$2,092	\$2,156	\$2,156	\$2,444	\$2,599



SERIES 500 WIDE STILE						
HAND	DESCRIPTION	FINISH CODE / DOOR PRICE				
		#11 CLEAR	#21 BRONZE	#81 WHITE	#2604 POWDER	#2605 POWDER
RH	3696WS-AO	\$1,087	\$1,117	\$1,117	\$1,284	\$1,382
LH	3696WS-BO	\$1,087	\$1,117	\$1,117	\$1,284	\$1,382
RH	4296WS-AO	\$1,139	\$1,163	\$1,163	\$1,348	\$1,449
LH	4296WS-BO	\$1,139	\$1,163	\$1,163	\$1,348	\$1,449
PAIR	7296WS-JO	\$2,210	\$2,276	\$2,276	\$2,600	\$2,765

Note: Add "DM001" to substitute DG101 Glass Stops used for 1" Insulated Glass.

**Butt Hinge - Offset Arm Frame Package Includes**

- 1 3/4" or 2" x 4 1/2" Open Back Frame
- Snap-in DS200 Door Stop w/pile
- 1/2" x 4" Threshold – Mill Finish
- Threshold Clips
- Prep for Lock Strike
- Prep for 1 1/2 Pair 4 1/2" x 4" Butt Hinges
- Prep for Top & Bottom Flush Bolts (pair)
- Prep for COC
- Frame assembly fastener package
- Applied DS202 Header Door stop

Note: All Hardware on Powder coat products is furnished in a standard clear finish.

Note: Standard Frame Height for Transom Frames = 10'-5 1/2".

Order Number Example: **3696-BO-FT2** (Size) - (Hand or Pair) - (Type)

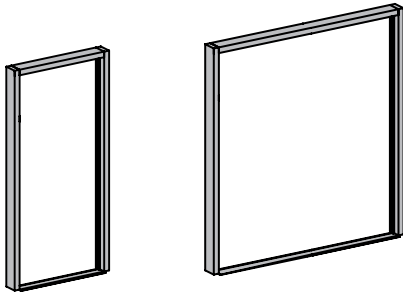

FL200 DOOR FRAME (Non-Transom)						
HAND	DESCRIPTION	FINISH CODE / FRAME PRICE				
		#11 CLEAR	#21 BRONZE	#81 WHITE	#2604 POWDER	#2605 POWDER
RH	3696-AO-F2	\$616	\$627	\$627	\$741	\$786
LH	3696-BO-F2	\$616	\$627	\$627	\$741	\$786
RH	4296-AO-F2	\$625	\$635	\$635	\$755	\$802
LH	4296-BO-F2	\$625	\$635	\$635	\$755	\$802
PAIR	7296-JO-F2	\$761	\$773	\$773	\$916	\$970

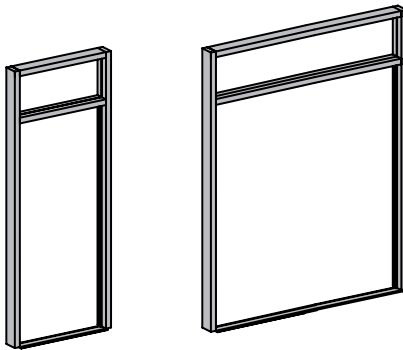

FL200 DOOR FRAME WITH TRANSMOM						
HAND	DESCRIPTION	FINISH CODE / FRAME PRICE				
		#11 CLEAR	#21 BRONZE	#81 WHITE	#2604 POWDER	#2605 POWDER
RH	3696-AO-FT2	\$794	\$809	\$809	\$963	\$1,026
LH	3696-BO-FT2	\$794	\$809	\$809	\$963	\$1,026
RH	4296-AO-FT2	\$811	\$826	\$826	\$991	\$1,057
LH	4296-BO-FT2	\$811	\$826	\$826	\$991	\$1,057
PAIR	7296-JO-FT2	\$986	\$1,007	\$1,007	\$1,221	\$1,302

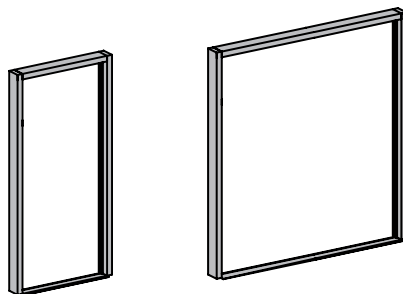

FL300 DOOR FRAME (Non-Transom)						
HAND	DESCRIPTION	FINISH CODE / FRAME PRICE				
		#11 CLEAR	#21 BRONZE	#81 WHITE	#2604 POWDER	#2605 POWDER
RH	3696-AO-F3	\$636	\$646	\$646	\$765	\$812
LH	3696-BO-F3	\$636	\$646	\$646	\$765	\$812
RH	4296-AO-F3	\$647	\$658	\$658	\$781	\$829
LH	4296-BO-F3	\$647	\$658	\$658	\$781	\$829
PAIR	7296-JO-F3	\$791	\$802	\$802	\$951	\$1,007

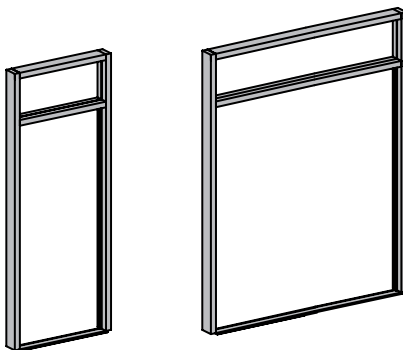

FL300 DOOR FRAME WITH TRANSMOM						
HAND	DESCRIPTION	FINISH CODE / FRAME PRICE				
		#11 CLEAR	#21 BRONZE	#81 WHITE	#2604 POWDER	#2605 POWDER
RH	3696-AO-FT3	\$842	\$861	\$861	\$1,047	\$1,120
LH	3696-BO-FT3	\$842	\$861	\$861	\$1,047	\$1,120
RH	4296-AO-FT3	\$860	\$879	\$879	\$1,077	\$1,154
LH	4296-BO-FT3	\$860	\$879	\$879	\$1,077	\$1,154
PAIR	7296-JO-FT3	\$1,039	\$1,064	\$1,064	\$1,315	\$1,407

# Entrances

## Standard Doors • Butt Hinge/Offset Arm/Panic



### Butt Hinge – CVR Panic – Offset Arm Door Package Includes

- Traditional 1" rd Pull/Push Hardware
- Slide Channel installed with Offset Arm
- Keyed Cylinder Exterior - Single or Active Leaf
- Glass Stops for ¼" Glazing
- One Pair 4½" x 4" Butt Hinges
- DH3692 CVR Touch Bar Panic(s)

Note: Reference Hardware Section of the Price Catalog for Door Closers and Loose Hardware Items not included in Standard Entrance section.

Note: All Hardware on Powder coat products is furnished in a standard clear finish.

Note: D102 Top Rail on Narrow Stile Doors with offset arm.

Order Number Example: 3684MS-AOP (Size and Series) - (Hand or Pair)



SERIES 213 NARROW STILE						
HAND	DESCRIPTION	FINISH CODE / DOOR PRICE				
		#11 CLEAR	#21 BRONZE	#81 WHITE	#2604 POWDER	#2605 POWDER
RH	3684-AOP	\$1,291	\$1,306	\$1,306	\$1,422	\$1,501
LH	3684-BOP	\$1,291	\$1,306	\$1,306	\$1,422	\$1,501
RH	4284-AOP	\$1,321	\$1,336	\$1,336	\$1,460	\$1,542
LH	4284-BOP	\$1,321	\$1,336	\$1,336	\$1,460	\$1,542
PAIR	7284-JOP	\$2,620	\$2,653	\$2,653	\$2,860	\$2,985



SERIES 380 MEDIUM STILE						
HAND	DESCRIPTION	FINISH CODE / DOOR PRICE				
		#11 CLEAR	#21 BRONZE	#81 WHITE	#2604 POWDER	#2605 POWDER
RH	3684MS-AOP	\$1,354	\$1,371	\$1,371	\$1,508	\$1,593
LH	3684MS-BOP	\$1,354	\$1,371	\$1,371	\$1,508	\$1,593
RH	4284MS-AOP	\$1,388	\$1,405	\$1,405	\$1,551	\$1,640
LH	4284MS-BOP	\$1,388	\$1,405	\$1,405	\$1,551	\$1,640
PAIR	7284MS-JOP	\$2,748	\$2,828	\$2,828	\$2,960	\$3,060



SERIES 500 WIDE STILE						
HAND	DESCRIPTION	FINISH CODE / DOOR PRICE				
		#11 CLEAR	#21 BRONZE	#81 WHITE	#2604 POWDER	#2605 POWDER
RH	3684WS-AOP	\$1,407	\$1,423	\$1,423	\$1,580	\$1,666
LH	3684WS-BOP	\$1,407	\$1,423	\$1,423	\$1,580	\$1,666
RH	4284WS-AOP	\$1,441	\$1,456	\$1,456	\$1,620	\$1,714
LH	4284WS-BOP	\$1,441	\$1,456	\$1,456	\$1,620	\$1,714
PAIR	7284WS-JOP	\$2,852	\$2,887	\$2,887	\$3,183	\$3,335

Note: Add "DM001" to substitute DG101 Glass Stops used for 1" Insulated Glass.



**Butt Hinge – CVR Panic – Offset Arm Frame Package Includes**

- 1 3/4" or 2" x 4 1/2" Open Back Frame
- Snap-in DS200 Door Stop w/pile
- 1/2" x 4" Threshold – Mill Finish
- Prep for DH3692 CVR Panic(s)
- Prep for One Pair 4 1/2" x 4" Butt Hinges
- Threshold Clips
- Prep for COC
- Frame assembly fastener package
- Applied DS202 Header Door stop

Note: All Hardware on Powder coat products is furnished in a standard clear finish.

Note: Standard Frame Height for Transom Frames = 10' - 5 1/2".

Order Number Example: 3684-AOP-FT2 (Size) - (Hand or Pair) - (Type)

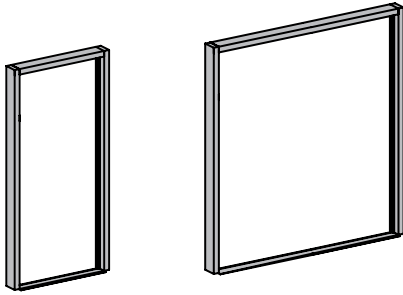

FL200 DOOR FRAME (Non-Transom)						
HAND	DESCRIPTION	FINISH CODE / FRAME PRICE				
		#11 CLEAR	#21 BRONZE	#81 WHITE	#2604 POWDER	#2605 POWDER
RH	3684-AOP-F2	\$591	\$600	\$600	\$700	\$741
LH	3684-BOP-F2	\$591	\$600	\$600	\$700	\$741
RH	4284-AOP-F2	\$601	\$608	\$608	\$714	\$756
LH	4284-BOP-F2	\$601	\$608	\$608	\$714	\$756
PAIR	7284-JOP-F2	\$731	\$740	\$740	\$871	\$920

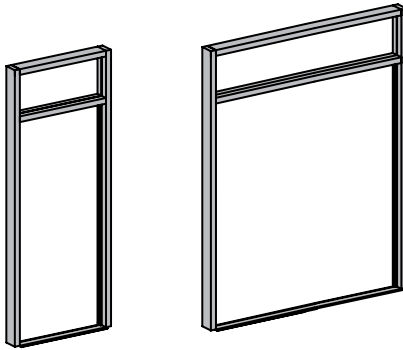

FL200 DOOR FRAME WITH TRANSOM						
HAND	DESCRIPTION	FINISH CODE / FRAME PRICE				
		#11 CLEAR	#21 BRONZE	#81 WHITE	#2604 POWDER	#2605 POWDER
RH	3684-AOP-FT2	\$791	\$805	\$805	\$954	\$1,015
LH	3684-BOP-FT2	\$791	\$805	\$805	\$954	\$1,015
RH	4284-AOP-FT2	\$807	\$823	\$823	\$982	\$1,046
LH	4284-BOP-FT2	\$807	\$823	\$823	\$982	\$1,046
PAIR	7284-JOP-FT2	\$978	\$997	\$997	\$1,206	\$1,287

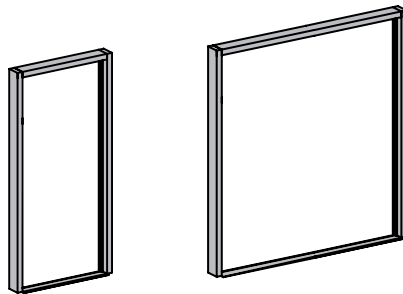

FL300 DOOR FRAME (Non-Transom)						
HAND	DESCRIPTION	FINISH CODE / FRAME PRICE				
		#11 CLEAR	#21 BRONZE	#81 WHITE	#2604 POWDER	#2605 POWDER
RH	3684-AOP-F3	\$611	\$620	\$620	\$724	\$766
LH	3684-BOP-F3	\$611	\$620	\$620	\$724	\$766
RH	4284-AOP-F3	\$621	\$629	\$629	\$739	\$783
LH	4284-BOP-F3	\$621	\$629	\$629	\$739	\$783
PAIR	7284-JOP-F3	\$761	\$770	\$770	\$905	\$956

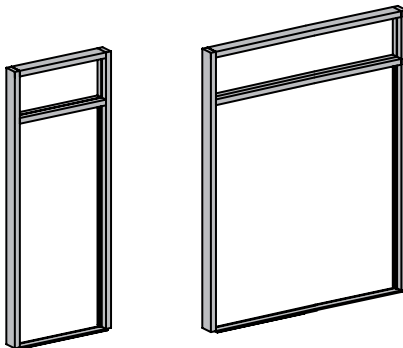

FL300 DOOR FRAME WITH TRANSOM						
HAND	DESCRIPTION	FINISH CODE / FRAME PRICE				
		#11 CLEAR	#21 BRONZE	#81 WHITE	#2604 POWDER	#2605 POWDER
RH	3684-AOP-FT3	\$852	\$872	\$872	\$1,066	\$1,140
LH	3684-BOP-FT3	\$852	\$872	\$872	\$1,066	\$1,140
RH	4284-AOP-FT3	\$868	\$889	\$889	\$1,094	\$1,172
LH	4284-BOP-FT3	\$868	\$889	\$889	\$1,094	\$1,172
PAIR	7284-JOP-FT3	\$1,043	\$1,068	\$1,068	\$1,326	\$1,421

# Entrances

## Standard Doors • Butt Hinge/Offset Arm/Panic

### Butt Hinge – CVR Panic – Offset Arm Door Package Includes

- Traditional 1" rd Pull/Push Hardware
- Slide Channel installed with Offset Arm
- Glass Stops for ¼" Glazing
- 1½ Pair 4½" x 4" Butt Hinges
- Keyed Cylinder Exterior - Single or Active Leaf
- DH3692 CVR Touch Bar Panic(s)

Note: Reference Hardware Section of the Price Catalog for Door Closers and Loose Hardware Items not included in Standard Entrance section.

Note: All Hardware on Powder coat products is furnished in a standard clear finish.

Note: D102 Top Rail on Narrow Stile Doors with offset arm.

Order Number Example: **3696MS-AOP** (Size and Series) - (Hand or Pair)



SERIES 213 NARROW STILE						
HAND	DESCRIPTION	FINISH CODE / DOOR PRICE				
		#11 CLEAR	#21 BRONZE	#81 WHITE	#2604 POWDER	#2605 POWDER
RH	3696-AOP	\$1,353	\$1,371	\$1,371	\$1,502	\$1,586
LH	3696-BOP	\$1,353	\$1,371	\$1,371	\$1,502	\$1,586
RH	4296-AOP	\$1,388	\$1,406	\$1,406	\$1,544	\$1,633
LH	4296-BOP	\$1,388	\$1,406	\$1,406	\$1,544	\$1,633
PAIR	7296-JOP	\$2,751	\$2,789	\$2,789	\$3,021	\$3,156



SERIES 380 MEDIUM STILE						
HAND	DESCRIPTION	FINISH CODE / DOOR PRICE				
		#11 CLEAR	#21 BRONZE	#81 WHITE	#2604 POWDER	#2605 POWDER
RH	3696MS-AOP	\$1,424	\$1,442	\$1,442	\$1,597	\$1,689
LH	3696MS-BOP	\$1,424	\$1,442	\$1,442	\$1,597	\$1,689
RH	4296MS-AOP	\$1,462	\$1,481	\$1,481	\$1,655	\$1,750
LH	4296MS-BOP	\$1,462	\$1,481	\$1,481	\$1,655	\$1,750
PAIR	7296MS-JOP	\$2,891	\$2,929	\$2,929	\$3,228	\$3,383



SERIES 500 WIDE STILE						
HAND	DESCRIPTION	FINISH CODE / DOOR PRICE				
		#11 CLEAR	#21 BRONZE	#81 WHITE	#2604 POWDER	#2605 POWDER
RH	3696WS-AOP	\$1,484	\$1,502	\$1,502	\$1,674	\$1,773
LH	3696WS-BOP	\$1,484	\$1,502	\$1,502	\$1,674	\$1,773
RH	4296WS-AOP	\$1,522	\$1,540	\$1,540	\$1,723	\$1,824
LH	4296WS-BOP	\$1,522	\$1,540	\$1,540	\$1,723	\$1,824
PAIR	7296WS-JOP	\$3,010	\$3,047	\$3,047	\$3,384	\$3,551

Note: Add "DM001" to substitute DG101 Glass Stops used for 1" Insulated Glass.



**Butt Hinge – CVR Panic – Offset Arm Frame Package Includes**

- 1 ¼" or 2" x 4 ½" Open Back Frame
- Snap-in DS200 Door Stop w/pile
- ½" x 4" Threshold – Mill Finish
- Prep for DH3692 CVR Panic(s)
- Prep for 1 ½ Pair 4 ½" x 4" Butt Hinges
- Threshold Clips
- Prep for COC
- Frame assembly fastener package
- Applied DS202 Header Door stop

*Note: All Hardware on Powder coat products is furnished in a standard clear finish.*

*Note: Standard Frame Height for Transom Frames = 10'-5 ½".*

*Order Number Example: 3696-AOP-FT2 (Size) - (Hand or Pair) - (Type)*

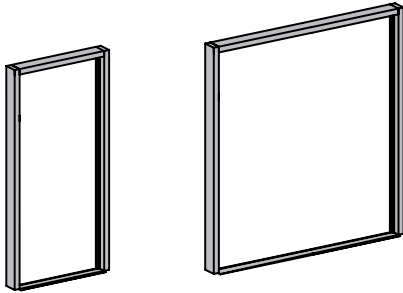

FL200 DOOR FRAME (Non-Transom)						
HAND	DESCRIPTION	FINISH CODE / FRAME PRICE				
		#11 CLEAR	#21 BRONZE	#81 WHITE	#2604 POWDER	#2605 POWDER
RH	3696-AOP-F2	\$636	\$645	\$645	\$759	\$804
LH	3696-BOP-F2	\$636	\$645	\$645	\$759	\$804
RH	4296-AOP-F2	\$646	\$655	\$655	\$774	\$821
LH	4296-BOP-F2	\$646	\$655	\$655	\$774	\$821
PAIR	7296-JOP-F2	\$780	\$791	\$791	\$935	\$989

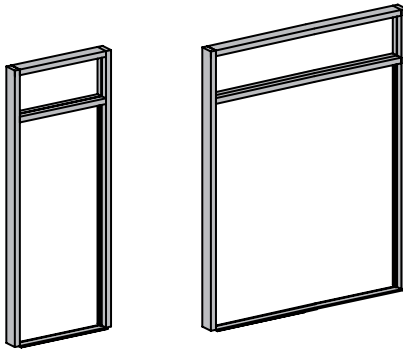

FL200 DOOR FRAME WITH TRANSOM						
HAND	DESCRIPTION	FINISH CODE / FRAME PRICE				
		#11 CLEAR	#21 BRONZE	#81 WHITE	#2604 POWDER	#2605 POWDER
RH	3696-AOP-FT2	\$814	\$829	\$829	\$983	\$1,045
LH	3696-BOP-FT2	\$814	\$829	\$829	\$983	\$1,045
RH	4296-AOP-FT2	\$829	\$846	\$846	\$1,010	\$1,075
LH	4296-BOP-FT2	\$829	\$846	\$846	\$1,010	\$1,075
PAIR	7296-JOP-FT2	\$1,007	\$1,025	\$1,025	\$1,239	\$1,322

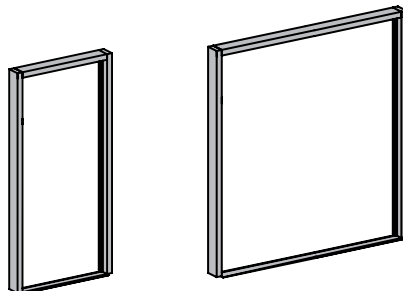

FL300 DOOR FRAME (Non-Transom)						
HAND	DESCRIPTION	FINISH CODE / FRAME PRICE				
		#11 CLEAR	#21 BRONZE	#81 WHITE	#2604 POWDER	#2605 POWDER
RH	3696-AOP-F3	\$657	\$667	\$667	\$784	\$832
LH	3696-BOP-F3	\$657	\$667	\$667	\$784	\$832
RH	4296-AOP-F3	\$667	\$677	\$677	\$800	\$849
LH	4296-BOP-F3	\$667	\$677	\$677	\$800	\$849
PAIR	7296-JOP-F3	\$811	\$822	\$822	\$970	\$1,026

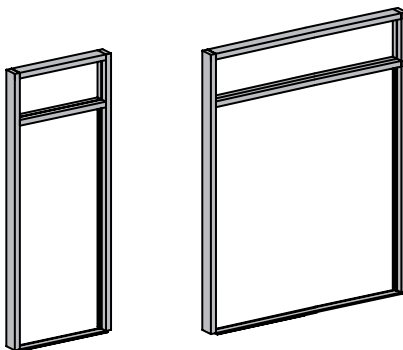

FL300 DOOR FRAME WITH TRANSOM						
HAND	DESCRIPTION	FINISH CODE / FRAME PRICE				
		#11 CLEAR	#21 BRONZE	#81 WHITE	#2604 POWDER	#2605 POWDER
RH	3696-AOP-FT3	\$861	\$880	\$880	\$1,067	\$1,140
LH	3696-BOP-FT3	\$861	\$880	\$880	\$1,067	\$1,140
RH	4296-AOP-FT3	\$878	\$898	\$898	\$1,096	\$1,173
LH	4296-BOP-FT3	\$878	\$898	\$898	\$1,096	\$1,173
PAIR	7296-JOP-FT3	\$1,059	\$1,082	\$1,082	\$1,333	\$1,425

# Entrances

## Standard Doors • Center Pivot



### Center Pivot Door Package Includes

- Traditional 1" BTB Push Bars
- Glass Stops for 1/4" Glazing
- DH114 Center Pivot Btm Door
- DH147 Side Load Arm Package
- MS Hook Bolt - Single or Active Leaf
- Top & Bottom Flush Bolts Inactive Leaf
- Keyed Cylinder Exterior
- Thumb Turn Interior

*Note: Reference Hardware Section of the Price Catalog for Door Closers and Loose Hardware Items not included in Standard Entrance section.*

*Note: All Hardware on Powder coat products is furnished in a standard clear finish.*

Order Number Example: **3684MS-H**(Size and Series) - (Hand or Pair)



SERIES 213 NARROW STILE						
HAND	DESCRIPTION	FINISH CODE / DOOR PRICE				
		#11 CLEAR	#21 BRONZE	#81 WHITE	#2604 POWDER	#2605 POWDER
RH	3684-G	\$843	\$908	\$908	\$985	\$1,061
LH	3684-H	\$843	\$908	\$908	\$985	\$1,061
RH	4284-G	\$926	\$956	\$956	\$1,078	\$1,155
LH	4284-H	\$926	\$956	\$956	\$1,078	\$1,155
PAIR	7284-M	\$1,728	\$1,861	\$1,861	\$2,000	\$2,110



SERIES 380 MEDIUM STILE						
HAND	DESCRIPTION	FINISH CODE / DOOR PRICE				
		#11 CLEAR	#21 BRONZE	#81 WHITE	#2604 POWDER	#2605 POWDER
RH	3684MS-G	\$933	\$1,003	\$1,003	\$1,095	\$1,175
LH	3684MS-H	\$933	\$1,003	\$1,003	\$1,095	\$1,175
RH	4284MS-G	\$1,021	\$1,056	\$1,056	\$1,194	\$1,278
LH	4284MS-H	\$1,021	\$1,056	\$1,056	\$1,194	\$1,278
PAIR	7284MS-M	\$1,892	\$2,032	\$2,032	\$2,222	\$2,359



SERIES 500 WIDE STILE						
HAND	DESCRIPTION	FINISH CODE / DOOR PRICE				
		#11 CLEAR	#21 BRONZE	#81 WHITE	#2604 POWDER	#2605 POWDER
RH	3684WS-G	\$985	\$1,056	\$1,056	\$1,163	\$1,249
LH	3684WS-H	\$985	\$1,056	\$1,056	\$1,163	\$1,249
RH	4284WS-G	\$1,073	\$1,110	\$1,110	\$1,263	\$1,353
LH	4284WS-H	\$1,073	\$1,110	\$1,110	\$1,263	\$1,353
PAIR	7284WS-M	\$1,997	\$2,140	\$2,140	\$2,353	\$2,501

*Note: Add "DM001" to substitute DG101 Glass Stops used for 1" Insulated Glass.*

**Center Pivot Frame Package Includes**

- 1¼" or 2" x 4½" Open Back Frame
- ½" x 4" Threshold – Mill Finish
- DH116 Center Pivot Threshold Mounted
- Threshold Clips
- Prep for Lock Strike
- Prep for Top & Bottom Flush Bolts (pair)
- Prep for COC
- CS112 COC Cover Plate
- Frame assembly fastener package

Note: All Hardware on Powder coat products is furnished in a standard clear finish.

Note: Standard Frame Height for Transom Frames = 10'-5 ½".

Order Number Example: **3684-DO-FT2** (Size) - (Hand or Pair) - (Type)

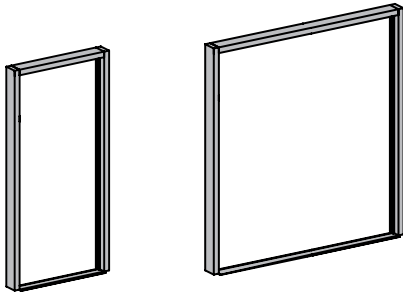

FL200 DOOR FRAME (Non-Transom)						
HAND	DESCRIPTION	FINISH CODE / FRAME PRICE				
		#11 CLEAR	#21 BRONZE	#81 WHITE	#2604 POWDER	#2605 POWDER
RH	3684-G-F2	\$600	\$615	\$615	\$681	\$711
LH	3684-H-F2	\$600	\$615	\$615	\$681	\$711
RH	4284-G-F2	\$607	\$624	\$624	\$690	\$720
LH	4284-H-F2	\$607	\$624	\$624	\$690	\$720
PAIR	7284-M-F2	\$707	\$728	\$728	\$804	\$835

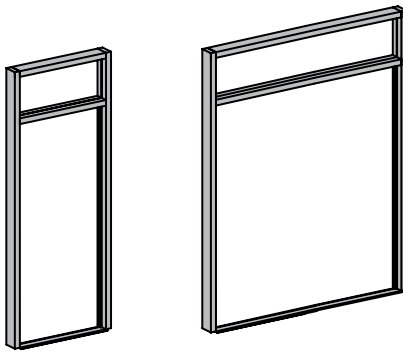

FL200 DOOR FRAME WITH TRANSOM						
HAND	DESCRIPTION	FINISH CODE / FRAME PRICE				
		#11 CLEAR	#21 BRONZE	#81 WHITE	#2604 POWDER	#2605 POWDER
RH	3684-G-FT2	\$773	\$805	\$805	\$938	\$991
LH	3684-H-FT2	\$773	\$805	\$805	\$938	\$991
RH	4284-G-FT2	\$789	\$822	\$822	\$961	\$1,017
LH	4284-H-FT2	\$789	\$822	\$822	\$961	\$1,017
PAIR	7284-M-FT2	\$938	\$981	\$981	\$1,141	\$1,207

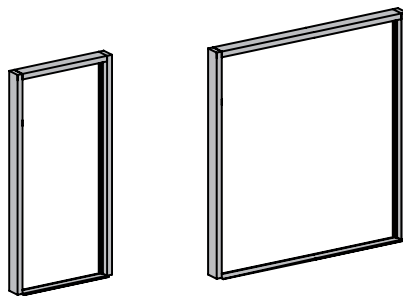

FL300 DOOR FRAME (Non-Transom)						
HAND	DESCRIPTION	FINISH CODE / FRAME PRICE				
		#11 CLEAR	#21 BRONZE	#81 WHITE	#2604 POWDER	#2605 POWDER
RH	3684-G-F3	\$620	\$635	\$635	\$701	\$731
LH	3684-H-F3	\$620	\$635	\$635	\$701	\$731
RH	4284-G-F3	\$629	\$647	\$647	\$719	\$749
LH	4284-H-F3	\$629	\$647	\$647	\$719	\$749
PAIR	7284-M-F3	\$737	\$758	\$758	\$838	\$871

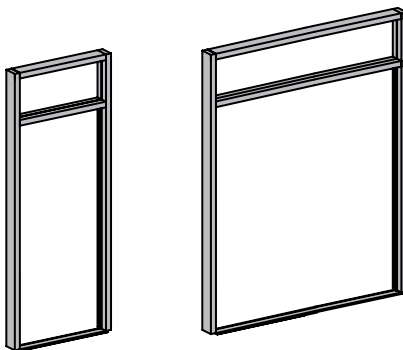

FL300 DOOR FRAME WITH TRANSOM						
HAND	DESCRIPTION	FINISH CODE / FRAME PRICE				
		#11 CLEAR	#21 BRONZE	#81 WHITE	#2604 POWDER	#2605 POWDER
RH	3684-G-FT3	\$832	\$865	\$865	\$1,005	\$1,061
LH	3684-H-FT3	\$832	\$865	\$865	\$1,005	\$1,061
RH	4284-G-FT3	\$847	\$882	\$882	\$1,025	\$1,085
LH	4284-H-FT3	\$847	\$882	\$882	\$1,025	\$1,085
PAIR	7284-M-FT3	\$993	\$1,035	\$1,035	\$1,207	\$1,276

# Entrances

## Standard Doors • Center Pivot



### Center Pivot Door Package Includes

- Traditional 1" BTB Push Bars
- Glass Stops for 1/4" Glazing
- DH114 Center Pivot Btm Door
- DH147 Side Load Arm Package
- MS Hook Bolt - Single or Active Leaf
- Top & Bottom Flush Bolts Inactive Leaf
- Keyed Cylinder Exterior
- Thumb Turn Interior

*Note: Reference Hardware Section of the Price Catalog for Door Closers and Loose Hardware Items not included in Standard Entrance section.  
Note: All Hardware on Powder coat products is furnished in a standard clear finish.*

Order Number Example: **3696MS-H**(Size and Series) - (Hand or Pair)



SERIES 213 NARROW STILE						
HAND	DESCRIPTION	FINISH CODE / DOOR PRICE				
		#11 CLEAR	#21 BRONZE	#81 WHITE	#2604 POWDER	#2605 POWDER
RH	3696-G	\$870	\$938	\$938	\$1,029	\$1,109
LH	3696-H	\$870	\$938	\$938	\$1,029	\$1,109
RH	4296-G	\$957	\$990	\$990	\$1,125	\$1,207
LH	4296-H	\$957	\$990	\$990	\$1,125	\$1,207
PAIR	7296-M	\$1,785	\$1,923	\$1,923	\$2,100	\$2,230



SERIES 380 MEDIUM STILE						
HAND	DESCRIPTION	FINISH CODE / DOOR PRICE				
		#11 CLEAR	#21 BRONZE	#81 WHITE	#2604 POWDER	#2605 POWDER
RH	3696MS-G	\$969	\$1,042	\$1,042	\$1,148	\$1,235
LH	3696MS-H	\$969	\$1,042	\$1,042	\$1,148	\$1,235
RH	4296MS-G	\$1,062	\$1,101	\$1,101	\$1,253	\$1,343
LH	4296MS-H	\$1,062	\$1,101	\$1,101	\$1,253	\$1,343
PAIR	7296MS-M	\$1,966	\$2,113	\$2,113	\$2,331	\$2,480



SERIES 500 WIDE STILE						
HAND	DESCRIPTION	FINISH CODE / DOOR PRICE				
		#11 CLEAR	#21 BRONZE	#81 WHITE	#2604 POWDER	#2605 POWDER
RH	3696WS-G	\$1,027	\$1,102	\$1,102	\$1,226	\$1,319
LH	3696WS-H	\$1,027	\$1,102	\$1,102	\$1,226	\$1,319
RH	4296WS-G	\$1,119	\$1,159	\$1,159	\$1,330	\$1,425
LH	4296WS-H	\$1,119	\$1,159	\$1,159	\$1,330	\$1,425
PAIR	7296WS-M	\$2,082	\$2,230	\$2,230	\$2,534	\$2,714

*Note: Add "DM001" to substitute DG101 Glass Stops used for 1" Insulated Glass.*

**Center Pivot Frame Package Includes**

- 1 3/4" or 2" x 4 1/2" Open Back Frame
- 1/2" x 4" Threshold – Mill Finish
- DH116 Center Pivot Threshold Mounted
- Threshold Clips
- Prep for Lock Strike
- Prep for Top & Bottom Flush Bolts (pair)
- Prep for COC
- CS112 COC Cover Plate
- Frame assembly fastener package

Note: All Hardware on Powder coat products is furnished in a standard clear finish.

Note: Standard Frame Height for Transom Frames = 10'-5 1/4".

Order Number Example: **3696-H-FT2** (Size) - (Hand or Pair) - (Type)

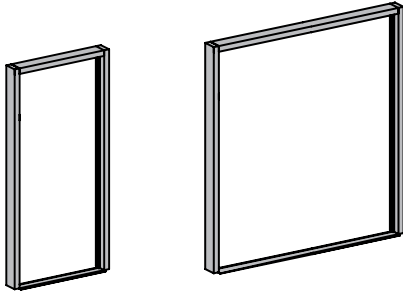

FL200 DOOR FRAME (Non-Transom)						
HAND	DESCRIPTION	FINISH CODE / FRAME PRICE				
		#11 CLEAR	#21 BRONZE	#81 WHITE	#2604 POWDER	#2605 POWDER
RH	3696-G-F2	\$618	\$636	\$636	\$711	\$742
LH	3696-H-F2	\$618	\$636	\$636	\$711	\$742
RH	4296-G-F2	\$626	\$643	\$643	\$721	\$753
LH	4296-H-F2	\$626	\$643	\$643	\$721	\$753
PAIR	7296-M-F2	\$678	\$699	\$699	\$839	\$890

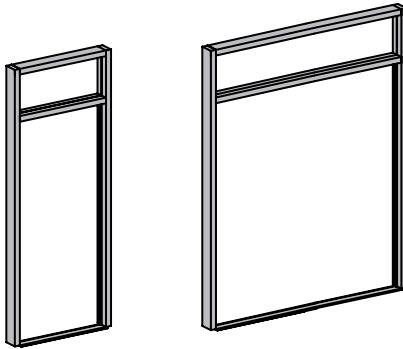

FL200 DOOR FRAME WITH TRANSOM						
HAND	DESCRIPTION	FINISH CODE / FRAME PRICE				
		#11 CLEAR	#21 BRONZE	#81 WHITE	#2604 POWDER	#2605 POWDER
RH	3696-G-FT2	\$766	\$795	\$795	\$923	\$975
LH	3696-H-FT2	\$766	\$795	\$795	\$923	\$975
RH	4296-G-FT2	\$782	\$813	\$813	\$945	\$998
LH	4296-H-FT2	\$782	\$813	\$813	\$945	\$998
PAIR	7296-M-FT2	\$882	\$921	\$921	\$1,122	\$1,196

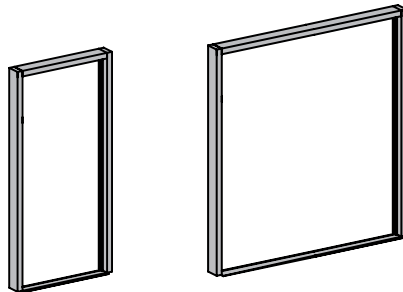

FL300 DOOR FRAME (Non-Transom)						
HAND	DESCRIPTION	FINISH CODE / FRAME PRICE				
		#11 CLEAR	#21 BRONZE	#81 WHITE	#2604 POWDER	#2605 POWDER
RH	3696-G-F3	\$632	\$649	\$649	\$728	\$761
LH	3696-H-F3	\$632	\$649	\$649	\$728	\$761
RH	4296-G-F3	\$646	\$663	\$663	\$741	\$783
LH	4296-H-F3	\$646	\$663	\$663	\$741	\$783
PAIR	7296-M-F3	\$708	\$729	\$729	\$869	\$920

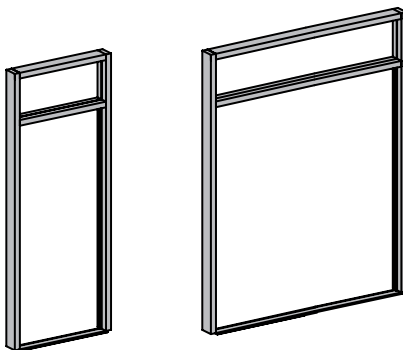

FL300 DOOR FRAME WITH TRANSOM						
HAND	DESCRIPTION	FINISH CODE / FRAME PRICE				
		#11 CLEAR	#21 BRONZE	#81 WHITE	#2604 POWDER	#2605 POWDER
RH	3696-G-FT3	\$824	\$854	\$854	\$989	\$1,042
LH	3696-H-FT3	\$824	\$854	\$854	\$989	\$1,042
RH	4296-G-FT3	\$838	\$872	\$872	\$1,011	\$1,067
LH	4296-H-FT3	\$838	\$872	\$872	\$1,011	\$1,067
PAIR	7296-M-FT3	\$936	\$975	\$975	\$1,187	\$1,263s

# Entrances

## Showroom Doors

**Continuous Geared Hinge – Door Package Includes**

- Traditional 1" rd Pull/Push Hardware (Active Only)
- Glass Stops for ¼" Glazing
- Heavy Duty Continuous Hinge
- Caster Support (Inactive Leaf)
- MS Hook Bolt - Single or Active Leaf
- Top & Bottom Steel Flush Bolts Inactive Leaf
- Keyed Cylinder Exterior
- Thumb Turn Interior

*Note: Reference Hardware Section of the Price Catalog for Door Closers and Loose Hardware Items not included in Standard Entrance section.  
Note: All Hardware on Powder coat products is furnished in a standard clear finish.*



Order Number Example: **9684JS-R**(Size and Series) - (Hand or Pair)

SERIES 213 NARROW STILE DOORS						
HAND	DESCRIPTION	FINISH CODE / DOOR PRICE				
		#11 CLEAR	#21 BRONZE	#81 WHITE	#2604 POWDER	#2605 POWDER
PAIR	9684-JSL	\$2,120	\$2,320	\$2,320	\$2,622	\$2,807
PAIR	9684-JSR	\$2,120	\$2,320	\$2,320	\$2,622	\$2,807



Order Number Example: **9684MS-R**(Size and Series) - (Hand or Pair)

SERIES 380 MEDIUM STILE DOORS						
HAND	DESCRIPTION	FINISH CODE / DOOR PRICE				
		#11 CLEAR	#21 BRONZE	#81 WHITE	#2604 POWDER	#2605 POWDER
PAIR	9684MS-JSL	\$2,303	\$2,522	\$2,522	\$2,850	\$3,052
PAIR	9684MS-JSR	\$2,303	\$2,522	\$2,522	\$2,850	\$3,052

**Continuous Geared Hinge –Frame Package Includes**

- 1½" or 2" x 4½" Open Back Frame
- Snap-in DS200 Door Stop w/pile
- ½ x 4" Threshold - Mill Finish
- Threshold clips
- Prep for Lock Strike
- Prep for Top and Bottom Flush Bolts (pair)
- Frame Assembly Fastener Package

*Note: Reference Hardware Section of the Price Catalog for Door Closers and Loose Hardware Items not included in Standard Entrance section.  
Note: All Hardware on Powder coat products is furnished in a standard clear finish.*

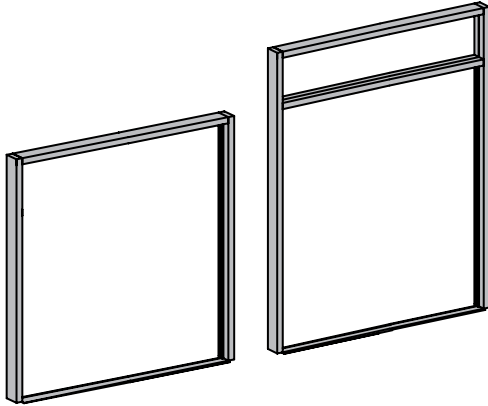

FL200 DOOR FRAMES						
HAND	DESCRIPTION	FINISH CODE / FRAME PRICE				
		#11 CLEAR	#21 BRONZE	#81 WHITE	#2604 POWDER	#2605 POWDER
PAIR	9684-JSL-F2 9684-JSR-F2	\$581	\$593	\$593	\$723	\$771
PAIR	9684-JSL-FT2 9684-JSR-FT2	\$826	\$888	\$888	\$1,083	\$1,154

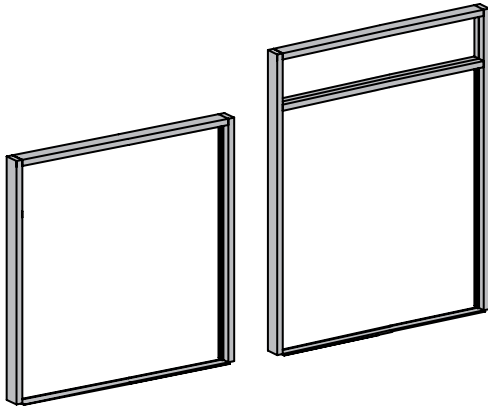

FL300 DOOR FRAMES						
HAND	DESCRIPTION	FINISH CODE / FRAME PRICE				
		#11 CLEAR	#21 BRONZE	#81 WHITE	#2604 POWDER	#2605 POWDER
PAIR	9684-JSL-F3 9684-JSR-F3	\$597	\$651	\$651	\$794	\$846
PAIR	9684-JSL-FT3 9684-JSR-FT3	\$871	\$892	\$892	\$1,088	\$1,160



# Entrances

## Showroom Doors

**Continuous Geared Hinge – Door Package Includes**

- Traditional 1" rd Pull/Push Hardware (Active Only)
- Glass Stops for 1/4" Glazing
- Heavy Duty Continuous Hinge
- Caster Support (Inactive Leaf)
- MS Hook Bolt - Single or Active Leaf
- Top & Bottom Steel Flush Bolts Inactive Leaf
- Keyed Cylinder Exterior
- Thumb Turn Interior

*Note: Reference Hardware Section of the Price Catalog for Door Closers and Loose Hardware Items not included in Standard Entrance section.*

*Note: All Hardware on Powder coat products is furnished in a standard clear finish.*



Order Number Example: **9684JS-R**(Size and Series) - (Hand or Pair)

SERIES 213 NARROW STILE DOORS						
HAND	DESCRIPTION	FINISH CODE / DOOR PRICE				
		#11 CLEAR	#21 BRONZE	#81 WHITE	#2604 POWDER	#2605 POWDER
PAIR	9696-JSL	\$2,299	\$2,534	\$2,534	\$2,863	\$3,066
PAIR	9696-JSR	\$2,299	\$2,534	\$2,534	\$2,863	\$3,066



Order Number Example: **9684JS-R**(Size and Series) - (Hand or Pair)

SERIES 380 MEDIUM STILE DOORS						
HAND	DESCRIPTION	FINISH CODE / DOOR PRICE				
		#11 CLEAR	#21 BRONZE	#81 WHITE	#2604 POWDER	#2605 POWDER
PAIR	9696MS-JSL	\$2,499	\$2,757	\$2,757	\$3,115	\$3,336
PAIR	9696MS-JSR	\$2,499	\$2,757	\$2,757	\$3,115	\$3,336



**Continuous Geared Hinge –Frame Package Includes**

- 1¼" or 2" x 4½" Open Back Frame
- Snap-in DS200 Door Stop w/pile
- ½ x 4" Threshold - Mill Finish
- Threshold clips
- Prep for Lock Strike
- Prep for Top and Bottom Flush Bolts (pair)
- Frame Assembly Fastener Package

*Note: Reference Hardware Section of the Price Catalog for Door Closers and Loose Hardware Items not included in Standard Entrance section.*

*Note: All Hardware on Powder coat products is furnished in a standard clear finish.*

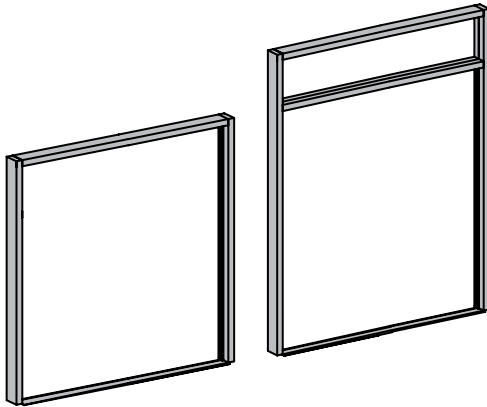

FL200 DOOR FRAMES						
HAND	DESCRIPTION	FINISH CODE / FRAME PRICE				
		#11 CLEAR	#21 BRONZE	#81 WHITE	#2604 POWDER	#2605 POWDER
PAIR	9696-JSL-F2 9696-JSR-F2	\$609	\$667	\$667	\$814	\$867
PAIR	9696-JSL-FT2 9696-JSR-FT2	\$829	\$896	\$896	\$1,093	\$1,165

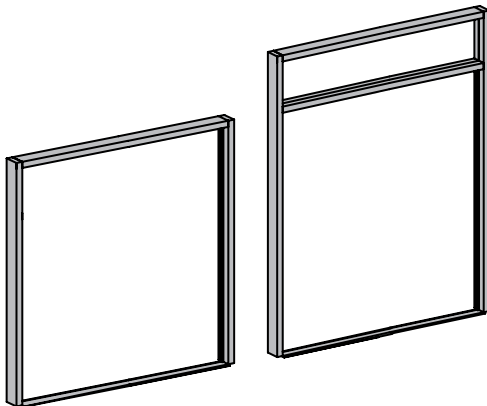

FL300 DOOR FRAMES						
HAND	DESCRIPTION	FINISH CODE / FRAME PRICE				
		#11 CLEAR	#21 BRONZE	#81 WHITE	#2604 POWDER	#2605 POWDER
PAIR	9696-JSL-F3 9696-JSR-F3	\$626	\$683	\$683	\$833	\$888
PAIR	9696-JSL-FT3 9696-JSR-FT3	\$838	\$906	\$906	\$1,105	\$1,178

Page Left Intentionally Blank

Section A2  
 Table of Contents

**ENTRANCES**

**Adds, Substitutions, and Modifications**

Glass Stops ..... 1

Push / Pulls ..... 1

Top Rail Substitutions - Stock Door..... 2

Bottom Rail Substitutions - Stock Door ..... 3

Horizontal Muntin Mid-Rail Adds - Standard Door ..... 4

Hinge Modifications and Substitutions ..... 5

Lock Substitutions .....6-7

Cylinder Substitutions ..... 8

Panic / Exit Devices..... 9



Door Width and Height Add ..... 10

Frame Width and Height Add..... 11

Page Left Intentionally Blank

Note: Part Finsh #11 = Clear & #21 Bronze

GLASS STOPS									
ITEM	DESCRIPTION	LENGTH	P/N	FINISH CODE / DOOR PRICE					
				#11	#21	#81	#99	#89	
<b>DG101</b> 	<b>Substitute</b> DG101 1" Glass Stops	N/A	DM001	N/C					

PUSH / PULL									
ITEM	DESCRIPTION	LENGTH	P/N	FINISH CODE / DOOR PRICE					
				#10	#20	#81	#99	#89	
<b>PB401</b> 	<b>Substitute</b> DH41 Back to Back Push Bars	36"	DM010	\$42	\$49	Default Finish is #10 unless otherwise specified  <b>Note: Hardware Finish</b> #10 = Clear #20 = Bronze			
		42"	DM011	\$51	\$65				
		60"	DM012	\$73	\$91				
<b>PH401</b> 	<b>Substitute</b> DH42 Back to Back Pull Handles	36"	DM013	\$0	\$0				
		42"	DM014	\$0	\$0				
		60"	DM015	\$0	\$0				

# Entrances



Adds, Substitutions, & Modifications



Note: Part Finish #11 = Clear & #21 Bronze

TOP RAIL								
ITEM	DESCRIPTION	LENGTH	P/N	FINISH CODE / DOOR PRICE				
				#11	#21	#81	#99	#89
	<b>Substitute</b> D102 for D101	36"	DM020	\$12	\$14	\$14	\$14	\$19
		42"	DM021	\$14	\$17	\$17	\$17	\$21
		60"	DM022	\$21	\$26	\$26	\$26	\$31
	<b>Substitute</b> D108 for D102	36"	DM023	\$14	\$19	\$19	\$19	\$26
		42"	DM024	\$17	\$21	\$21	\$21	\$28
		60"	DM025	\$26	\$31	\$31	\$31	\$41

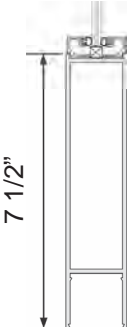
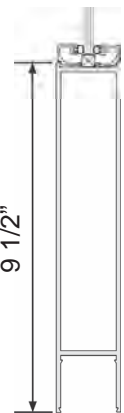
Note: Part Finish #11 = Clear & #21 Bronze

BOTTOM RAIL								
ITEM	DESCRIPTION	LENGTH	P/N	FINISH CODE / DOOR PRICE				
				#11	#21	#81	#99	#89
 <p>7 1/2"</p>	Substitute D108 for D102	36"	DM032	\$14	\$19	\$19	\$19	\$26
		42"	DM033	\$17	\$21	\$21	\$21	\$28
		60"	DM034	\$26	\$31	\$31	\$31	\$41
 <p>9 1/2"</p>	Substitute D109 for D102	36"	DM035	\$19	\$23	\$23	\$23	\$30
		42"	DM036	\$21	\$26	\$26	\$26	\$33
		60"	DM037	\$30	\$35	\$35	\$35	\$45
 <p>9 1/2"</p>	Substitute D109 for D108	36"	DM038	\$7	\$10	\$10	\$10	\$14
		42"	DM039	\$10	\$13	\$13	\$13	\$17
		60"	DM040	\$13	\$16	\$16	\$16	\$20

# Entrances

Adds, Substitutions, & Modifications



Note: Part Finish #11 = Clear & #21 Bronze

HORIZONTAL MUNTIN								
ITEM	DESCRIPTION	LENGTH	P/N	FINISH CODE / DOOR PRICE				
				#11	#21	#81	#99	#89
	<b>Add</b> 5/8" Horizontal Muntin	36"	DM050	\$163	\$167	\$167	\$167	\$174
		42"	DM051	\$167	\$174	\$174	\$174	\$182
		60"	DM052	\$189	\$202	\$202	\$202	\$213
	<b>Add</b> 2" Horizontal Muntin	36"	DM053	\$185	\$189	\$189	\$189	\$198
		42"	DM054	\$189	\$198	\$198	\$198	\$205
		60"	DM055	\$224	\$233	\$233	\$233	\$244
	<b>Add</b> 4" Mid-Rail	36"	DM056	\$189	\$198	\$198	\$198	\$205
		42"	DM057	\$194	\$202	\$202	\$202	\$213
		60"	DM059	\$229	\$240	\$240	\$240	\$255
	<b>Add</b> 7-1/2" Mid-Rail	36"	DM060	\$209	\$213	\$213	\$213	\$233
		42"	DM061	\$220	\$229	\$229	\$229	\$251
		60"	DM062	\$266	\$279	\$279	\$279	\$310
	<b>Add</b> 9-1/2" Mid-Rail	36"	DM063	\$220	\$229	\$229	\$229	\$255
		42"	DM064	\$236	\$244	\$244	\$244	\$275
		60"	DM065	\$290	\$301	\$301	\$301	\$345

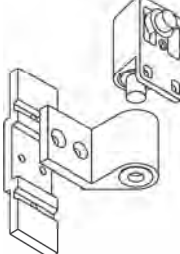
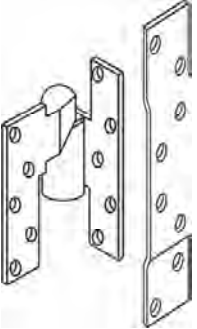
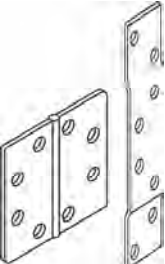
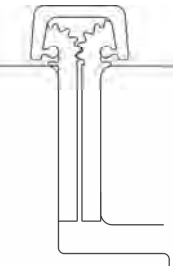

HINGE/PIVOT									
ITEM	DESCRIPTION	LENGTH	P/N	FINISH CODE / DOOR PRICE					
				#10	#20	#81	#99	#89	
<b>DH100</b> 	<b>Add</b> Standard DH100 Intermediate Pivot, Includes back-up plate and screws	N/A	DM075	\$101	\$105				
	<b>Substitute</b> DH107 LH or DH108 RH Intermediate Pivot, Includes back-up plates and screws	N/A	DM076	\$28	\$28				
<b>DH107/ DH108</b> 	<b>Add</b> DH107 LH or DH108 RH Intermediate Pivot, Includes back-up plates and screws	N/A	DM077	\$129	\$133				
	<b>Substitute</b> DH110SS Butt Hinge (Stainless Steel), Includes back-up plates and screws	N/A	DM081	\$14	\$14				
<b>DH110SS</b> 	<b>Add</b> DH110SS Butt Hinge (Stainless Steel), Includes back-up plates and screws	N/A	DM082	\$77	\$77				
	<b>DH111HD</b> 	<b>Substitute</b> HD Continuous Gear Hinge for Butt Hinge	84"	DM090	\$182	\$238			
96"			DM091	\$196	\$273				
108"			DM092	\$315	\$392				

Default Finish is #10 unless otherwise specified

Note: Hardware Finish  
#10 = Clear  
#20 = Bronze

# Entrances

Adds, Substitutions, & Modifications

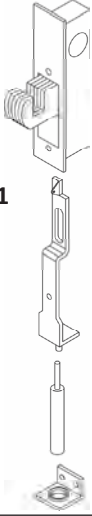
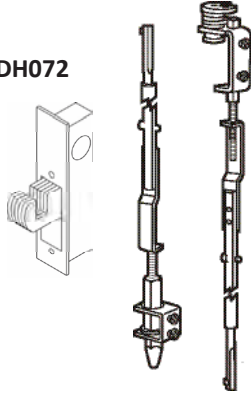
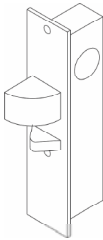
LOCKS								
ITEM	DESCRIPTION	LENGTH	P/N	FINISH CODE / DOOR PRICE				
				#10	#20	#81	#99	#89
 <p><b>DH071</b></p>	<p><b>Substitute</b> DH071 2 Pt Lock, Includes faceplate</p>	N/A	DM100	\$121	\$121			
 <p><b>DH072</b></p>	<p><b>Substitute</b> DH072 3 Pt Lock, Includes faceplate</p>	N/A	DM101	\$147	\$147			
 <p><b>DH084</b></p>	<p><b>Substitute</b> DH084 Deadlatch Includes faceplate</p>	N/A	DM104	\$112	\$112			

Default Finish is #10 unless otherwise specified

**Note: Hardware Finish**  
#10 = Clear  
#20 = Bronze

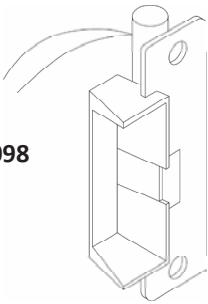
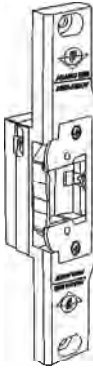
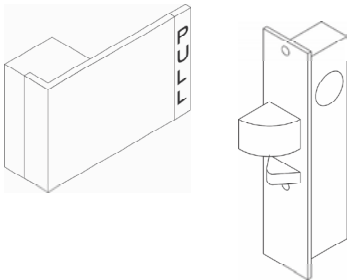
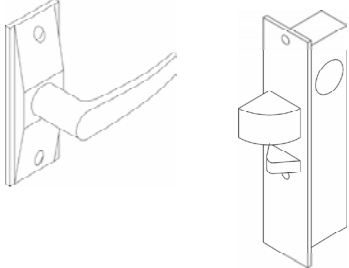
LOCKS						
ITEM	DESCRIPTION	LENGTH	P/N	FINISH CODE / DOOR PRICE		
				#10	#20	
 <p><b>DH098</b></p>	<p><b>Add</b> DH098 Electric Strike</p>	N/A	DM105	\$359	\$359	
 <p><b>DH099</b></p>	<p><b>Add</b> DH099 Electric Strike for Rim Panic</p>	N/A	DM106	\$455	\$455	
 <p><b>DH091</b>      <b>DH084</b></p>	<p><b>Substitute</b> DH084 Deadlatch with Cam and Paddle Handle</p>	N/A	DM110	\$166	\$166	
 <p><b>DH093</b>      <b>DH084</b></p>	<p><b>Substitute</b> DH084 Deadlatch with Cam and DH093 Lever</p>	N/A	DM111	\$146	\$146	



Default Finish is #10  
unless otherwise  
specified

**Note: Hardware Finish**  
#10 = Clear  
#20 = Bronze

# Entrances

## Adds, Substitutions, & Modifications

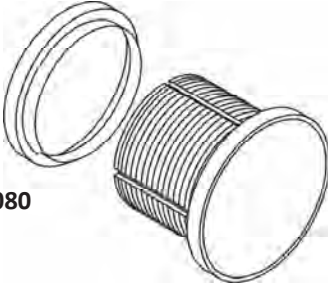

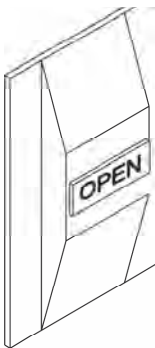
Note: 10=Clear 20=Bronze

CYLINDERS								
ITEM	DESCRIPTION	LENGTH	P/N	FINISH CODE / DOOR PRICE				
				#10	#20	#81	#99	#89
 <p><b>DH078</b></p>	<p><b>Substitute</b> DH078 Cylinder</p>	N/A	DM120	N/C	N/C			
 <p><b>DH080</b></p>	<p><b>Substitute</b> DH080 Dummy Cylinder</p>	N/A	DM121	N/C	N/C			
 <p><b>DH082</b></p>	<p><b>Add</b> DH082 Cylinder Guard</p>	N/A	DM122	\$14	\$14			
 <p><b>DH074</b></p>	<p><b>Add</b> DH074 Lock Indicator</p>	N/A	DM123	\$14	\$14			

Default Finish is #10  
unless otherwise  
specified

**Note: Hardware Finish**  
#10 = Clear  
#20 = Bronze

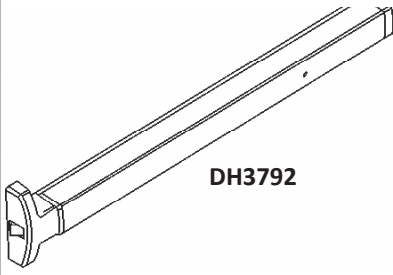
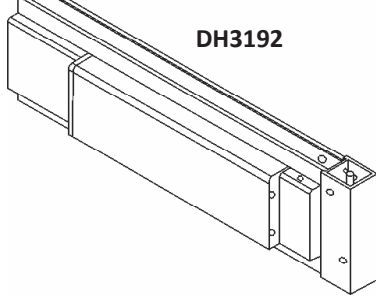
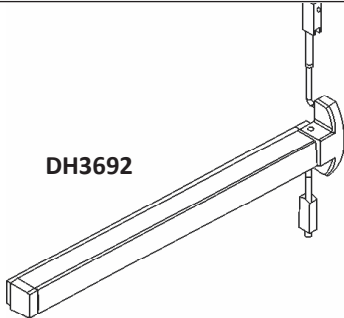
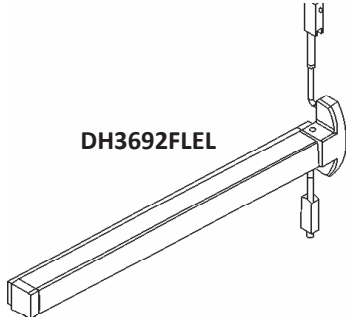

Note: 10=Clear 20=Bronze



PANICS / EXIT DEVICES								
ITEM	DESCRIPTION	LENGTH	P/N	FINISH CODE / DOOR PRICE				
				#10	#20	#81	#99	#89
 <p><b>DH3792</b></p>	<p><b>Add</b> First Choice 3792 RIM Panic (Priced Per Leaf)</p>	36"	DM135	\$483	\$493	Default Finish is #10 unless otherwise specified  <b>Note: Hardware Finish</b> #10 = Clear #20 = Bronze		
		42"	DM136	\$402	\$404			
		48"	DM137	\$409	\$411			
 <p><b>DH3192</b></p>	<p><b>Add</b> First Choice 3192 Mid Panel Panic (Priced Per Leaf)</p>	36"	DM138	\$868	\$882	\$882	\$896	\$910
		42"	DM139	\$896	\$910	\$910	\$924	\$938
		48"	DM140	\$924	\$938	\$938	\$952	\$966
 <p><b>DH3692</b></p>	<p><b>Add</b> First Choice 3692 Panic (Priced Per Leaf)</p>	36"	DM141	\$532	\$539	Default Finish is #10 unless otherwise specified  <b>Note: Hardware Finish</b> #10 = Clear #20 = Bronze		
		42"	DM142	\$539	\$546			
		48"	DM143	\$546	\$553			
 <p><b>DH3692FLEL</b></p>	<p><b>Add</b> First Choice 3692FLEL Panic Motorized Electric (Priced Per Leaf)</p>	36"	DM147	\$1,820	\$1,820	Default Finish is #10 unless otherwise specified  <b>Note: Hardware Finish</b> #10 = Clear #20 = Bronze		
		42"	DM148	\$1,890	\$1,890			
		48"	DM149	\$1,960	\$1,960			
 <p><b>DHC-EPT</b></p>	<p><b>Add</b> Securitron Electrical Power Transfer (Priced Per Leaf)</p>	N/A	DM180	\$259				

# Entrances

## Adds, Substitutions, & Modifications

Note: Part Finsh #11 = Clear & #21 Bronze

DOOR WIDTH ADD								
ITEM	DESCRIPTION	STILE	P/N	FINISH CODE / DOOR PRICE				
				#11	#21	#81	#99	#89
	ADD Single Door Width >42" up to 48"	NS	DM201	\$112	\$119	\$119	\$126	\$133
		MS	DM202	\$119	\$126	\$126	\$133	\$140
		WS	DM203	\$126	\$133	\$133	\$140	\$147
	ADD Pair Door Width >72" up to 84"	NS	DM206	\$224	\$238	\$238	\$252	\$266
		MS	DM207	\$238	\$252	\$252	\$266	\$280
		WS	DM208	\$252	\$266	\$266	\$280	\$294

DOOR HEIGHT ADD								
ITEM	DESCRIPTION	STILE	P/N	FINISH CODE / DOOR PRICE				
				#10	#21	#81	#99	#89
	ADD Single Door Height >96" up to 108"	NS	DM210	\$63	\$70	\$70	\$84	\$91
		MS	DM211	\$70	\$77	\$77	\$91	\$98
		WS	DM212	\$77	\$84	\$84	\$98	\$84
	ADD Pair Door Height >96" up to 108"	NS	DM216	\$126	\$140	\$140	\$168	\$182
		MS	DM217	\$140	\$154	\$154	\$182	\$196
		WS	DM218	\$154	\$168	\$168	\$196	\$210

Note: Part Finish #11 = Clear & #21 Bronze

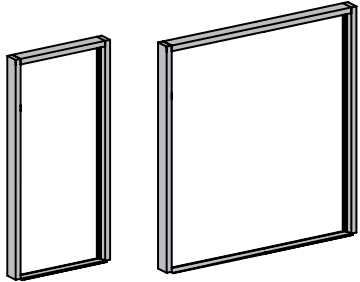
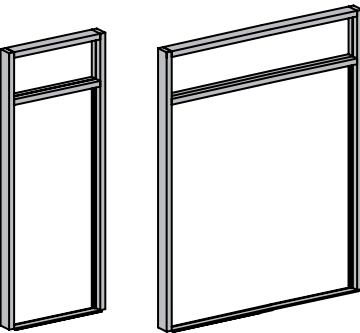
FRAME WIDTH ADD							
ITEM	DESCRIPTION	P/N	FINISH CODE / DOOR PRICE				
			#11	#21	#81	#99	#89
	Non Transom Single Door Frame Door Opening Width >42" Up To 48"	DM220	\$28	\$35	\$35	\$42	\$49
	Non Transom Pair Door Frame Door Opening Width >72" Up To 84"	DM221	\$35	\$42	\$42	\$49	\$56
	Transom Single Door Frame Door Opening Width >42" Up To 48"	DM230	\$35	\$42	\$42	\$49	\$56
	Transom Pair Door Frame Door Opening Width >72" Up To 84"	DM231	\$42	\$49	\$49	\$56	\$63

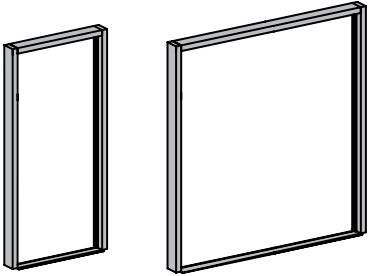
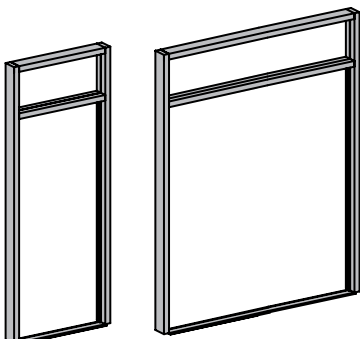
FRAME HEIGHT ADD							
ITEM	DESCRIPTION	P/N	FINISH CODE / DOOR PRICE				
			#10	#21	#81	#99	#89
	Non Transom Single Door Frame Door Opening Height >96" Up To 108"	DM240	\$26	\$28	\$28	\$35	\$42
	Non Transom Pair Door Frame Door Opening Height >96" Up To 108"	DM241	\$26	\$28	\$28	\$35	\$42
	Transom Single Door Frame Frame Height >125-1/2" Up To 144"	DM250	\$42	\$49	\$49	\$70	\$84
	Transom Pair Door Frame Frame Height >125-1/2" Up To 144"	DM251	\$42	\$49	\$49	\$70	\$84

Page Left Intentionally Blank











## Section A3 Table of Contents

### **ENTRANCES**

#### **Standard Loose Hardware**



Offset Pivots / Intermediate Pivots.....	1
Butt Hinges .....	2
Traditional Push / Pull Hardware .....	3
Locks, Cylinders, and Accesories .....	4 -7
Surface Closers .....	8
Concealed Overhead Closers.....	9
Center Pivots .....	10
First Choice Parts.....	11
Panic Devices.....	12 - 13
Removable Mullions and Door Sweeps .....	14
Stock Prefabricated Thresholds.....	15

Page Left Intentionally Blank

OFFSET PIVOTS / INTERMEDIATE PIVOTS							
ITEM	DESCRIPTION	P/N	FINISH CODE / DOOR PRICE				
			#10	#20	#81	#99	#89
DH101 	Top Frame Portion	DH101	\$7	\$7			
DH102 	Top Door Portion	DH102	\$7	\$7			
DH103 	Bottom Door Portion	DH103	\$11	\$11			
DH104 DH105 	Right Hand Floor Portion	DH104	\$7	\$7			
	Left Hand Floor Portion	DH105					
DH100 	Standard Intermediate Pivot. Sold as Package Only. Includes Frame Portion, Backup Plate, and Screws.	DH100	\$36	\$36			Default Finish is #10 unless otherwise specified  <b>Note: Hardware Finish</b> #10 = Clear #20 = Bronze
DH107 DH108 	Optional Left Hand Intermediate Pivot. Backup Plate and Screws Sold Separately.	DH107	\$36	\$36			
	Optional Right Hand Intermediate Pivot. Backup Plate and Screws Sold Separately.	DH108					
BP451 BP461 	Framed Backup Plate For DH107 or DH108	BP451	\$7	\$7			
	Framed Backup Plate For DH107 or DH108	BP461					
AS3-90 AS3-91 	12-24 x 1/2" PFHUCMS SS Screws for Intermediate Piv- ots, Butt Hinges and Backup Plates (100 per Pkg)	AS3-90	\$7	\$7			
		AS3-91					







# Entrances



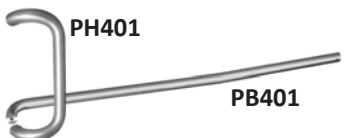
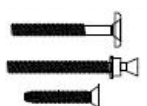

## Standard Loose Hardware

BUTT HINGES							
ITEM	DESCRIPTION	P/N	FINISH CODE / DOOR PRICE				
			#10	#20	#81	#99	#89
 <p><b>DH110SS</b></p>	<p>Standard Butt Hinge (Stainless Steel) 4½" x 4" Screws and Backup Plates Sold Separately</p>	DH110SS	\$22	\$22			
 <p><b>BP459</b> <b>BP450</b></p>	<p>Hinge Backup Plate For Doors (for DH109 - DH110SS)</p>	BP450	\$7	\$7			
		BP459					
	<p>Continuous Gear for 84" Door Height</p>	DH111HD-83	\$252	\$315			
	<p>Continuous Gear for 96" Door Height</p>	DH111HD-95	\$307	\$390			
	<p>Continuous Gear for 120" Door Height</p>	DH111HD -120	\$427	\$545			

Default Finish is #10  
unless otherwise  
specified

**Note: Hardware Finish**  
#10 = Clear  
#20 = Bronze





TRADITIONAL PUSH / PULL HARDWARE							
ITEM	DESCRIPTION	P/N	FINISH CODE / DOOR PRICE			#81	#89
			#10	#27	#20		
 <b>PB401</b>	1" Round Push Bar (Single) Includes DH159 Fastener Pkg	PB401-33 Doors up to 36"	\$55	\$72	\$72	Default Finish is #10 unless otherwise specified  <b>Note: Hardware Finish</b> #10 = Clear #20 = Bronze #27 = Champagne	
		PB401-39 Doors up to 42"	\$80	\$93	\$93		
		PB401-60 Doors up to 60"	\$118	\$152	\$152		
 <b>PH401</b>	1" Round x 90° Offset x 9" Ctrs Offset Pull Handle Includes DHXXX Fastener Pkg	PH401	\$34	\$38	\$47		
 <b>PH401</b> <b>PB401</b>	1" Round x 90° Offset x 9" Ctrs Offset Pull Handle 1" Round Push Bar Combo Includes DH157 Fastener Pkg	DH4036 (up to 36")	\$84	\$97	\$135		
		DH4042 (up to 42")	\$97	\$105	\$147		
		DH4060 (up to 60")	\$294	\$324	\$378		
	Hardware Fastener Package	DH157	\$13	N/A	\$16		
	1" Round Push Bar (Combo) Includes DH159 Fastener Pkg	DH4136	\$160	\$168	\$252		
		DH4142	\$194	\$210	\$219		
		DH4160	\$419	\$434	\$490		
		DH159	\$13	N/A	\$16		
	1" Round x 90° Offset x 9" Ctrs Offset Pull Handle Combo Includes DH158 Fastener Pkg	DH42	\$76	\$84	\$110		
	Hardware Fastener Package	DH158	\$13	N/A	N/A		

LOCKS, CYLINDERS, AND ACCESSORIES							
ITEM	DESCRIPTION	P/N	FINISH CODE / DOOR PRICE				
			#10	#20	#81	#99	#89
	Standard Hook Bolt Lock 1 1/2" Backset	DH070	\$17	N/A			
	Bevel Faceplate LH	DH060	\$4	\$4			
	Bevel Faceplate RH	DH061	\$4	\$4			
	Radius Faceplate	DH062	\$4	\$4			
	Standard Dead Latch (Latch Lock) 1 1/2" Backset Field Reversible Handing	DH084	\$22	N/A			
	Bevel Faceplate LH	DH065	\$4	\$4			
	Bevel Faceplate RH	DH064	\$4	\$4			
	Dead Latch Strike Includes Back Up Plate, Dust Box and Screws	DH090	\$11	N/A			

Default Finish is #10  
unless otherwise  
specified

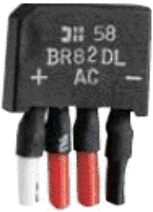
**Note: Hardware Finish**  
#10 = Clear  
#20 = Bronze

**LOCKS, CYLINDERS, AND ACCESSORIES**

ITEM	DESCRIPTION	P/N	FINISH CODE / DOOR PRICE				
			#10	#20	#81	#99	#89
	Electric Strike Door or Frame 1 1/4" x 6 7/8"	DH098	\$223	\$223			
	Adams Rite 4603 Rectifier Rated 2 amps (200PIV)	DHC-4603	\$18	\$N/A			
	Adams Rite 4605 Transformer Converts 120VAC to 12VAC/24VAC Rated 40 volt-amp output	DHC-4605	\$63	\$N/A			
	MS Dead Bolt Lever Handle With Lock Indicator Includes AR Cam	DH094L LH	\$245	\$245			
		DH094R RH	\$245	\$245			
	Latch Lock Lever Handle Field Reversible Includes AR Cam	DH093	\$22	\$22			
	Latch Lock Paddle Handle Field Reversible Includes AR Cam	DH091 LH	\$43	\$43			
		DH092 RH	\$43	\$43			



Default Finish is #10 unless otherwise specified

**Note: Hardware Finsh**  
#10 = Clear  
#20 = Bronze

# Entrances





## Standard Loose Hardware

Note: 10=Clear 20=Bronze

LOCKS, CYLINDERS, AND ACCESSORIES								
ITEM	DESCRIPTION	P/N	FINISH CODE / DOOR PRICE					
			#10	#20	#81	#99	#89	
	Impact-Resistant 3 Point Lock 1 1/2" Cylinder Backset	DH072	\$68					N/A
	Lock Indicator (Use With Dead Bolt Only)	DH074	\$7	\$7				
	Lever Operated Flush Bolt Standard With Nylon Tip	DH076 Up To 84"	\$11	\$11				Default Finish is #10 unless otherwise specified  Note: Hardware Finish #10 = Clear #20 = Bronze
		DH07696 Up To 96"	\$14	\$14				
	Lever Operated Flush Bolt Impact-Resistant With Steel Tips	DH176 Up To 84"	\$18	\$21				
		DH17696 Up To 96"	\$22	\$26				



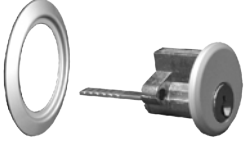



Note: 10=Clear 20=Bronze







LOCKS, CYLINDERS, AND ACCESSORIES							
ITEM	DESCRIPTION	P/N	FINISH CODE / DOOR PRICE				
			#10	#20	#81	#99	#89
	1 1/2" Diameter 5 Pin Keyed Lock Cylinder	DH078	\$7	\$7			
	1 1/2" Diameter Thumb Turn	DH079	\$7	\$7			
	1 1/2" Diameter Dummy Cylinder	DH080	\$7	\$7			
	1 1/2" Diameter 5 Pin Keyed Rim Cylinder	DH081	\$11	\$11			
	Cylinder Guard With Hardened Steel Collar	DH082	\$11	\$11			

Default Finish is #10  
 unless otherwise  
 specified  
 Note: Hardware Finsh  
 #10 = Clear  
 #20 = Bronze

# Entrances

## Standard Loose Hardware

SURFACE CLOSERS							
ITEM	DESCRIPTION	P/N	FINISH CODE / DOOR PRICE				
			#10	#20	#81	#99	#89
	<p><b>Tri-Style Surface Closer</b></p> <p>The Industry's most popular hole pattern, the CL026 Tri-Style Surface Closer is the most diverse 9-1/16" commercial door closer on the market today. It provides adjustments for sweep, back check, latch speed, and an adjustment spring tension of 1 to 5.</p> <ul style="list-style-type: none"> <li>• Grade 1 ANSI A156.4</li> <li>• Exceeds ADA Requirements ANSI 117.1</li> <li>• Adjustable back check sweep and latch speeds</li> <li>• Power adjustable 1 to 5</li> <li>• Tri-packed</li> <li>• Cover included</li> <li>• 9-1/16" x 3/4" hole pattern</li> <li>• Self-drilling screws</li> <li>• Includes Parallel arm bracket</li> </ul>	CL026	\$106	\$106			
	<p><b>Top Jamb Bracket</b></p>	CL030	\$18	\$18			
	<p><b>Drop Plate</b></p>	CL031	\$18	\$18			Default Finish is #10 unless otherwise specified
	<p><b>Barrier Free Adjustable Surface Closer</b></p> <p>The CL028 is one of the most reliable cast iron surface closers on the market today. Coral Architectural Products recommends this closer be used in medium to heavy traffic applications. The CL028 is fully adjustable and will service the heaviest doors, down to ADA compliant.</p> <ul style="list-style-type: none"> <li>• Grade 1 ANSI A156.4</li> <li>• Exceeds ADA Requirements ANSI 117.1</li> <li>• Adjustable back check sweep and latch speeds</li> <li>• Power adjustable 1 to 6</li> <li>• Tri-packed</li> <li>• Cover included</li> <li>• Self-drilling screws</li> <li>• Includes Parallel arm bracket</li> </ul>	CL028	\$240	\$240			Note: Hardware Finish #10 = Clear #20 = Bronze
	<p><b>Drop Plate</b></p>	CL033	\$43	\$43			



CONCEALED OVERHEAD CLOSERS						
ITEM	DESCRIPTION	P/N	FINISH CODE / DOOR PRICE			
			#10	#20	#81	#99
	Concealed Overhead Closer <ul style="list-style-type: none"> <li>• Dual Valves to Control Closing and Latching</li> <li>• Fits 1-3/4" x 4-1/2" 2" x 4-1/2" and 2-1/2" x 5" Headers</li> <li>• Closer Body Only</li> </ul>	CL190 90° Hold Open	\$231	N/A		
		CL105 105° Hold Open				
		CL290 90° No Hold Open				
		CL205 105° No Hold Open				
	Side Load Top Arm Assembly	DH147	\$43	N/A		
	Offset Arm Assembly Requires D102 (4") Top Rail on Narrow Stile 213 & 281 Doors	DH152	\$29	N/A		
	Slide Channel For Use With Offset Arm	DH153	\$29	N/A		
	Square Corner Cover Plate For Center Pivot	CS112-1	\$26	\$29		
	Rounded Corners Cover Plate For Offset Arm Applications	DH117	\$47	\$51		



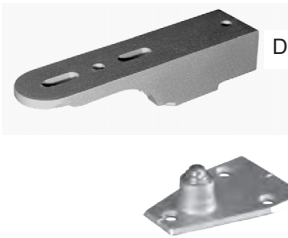

Default Finish is #10 unless otherwise specified

**Note: Hardware Finish**  
#10 = Clear  
#20 = Bronze

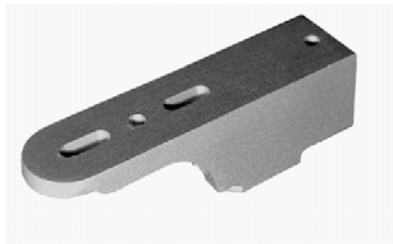
# Entrances





## Standard Loose Hardware





CENTER PIVOTS							
ITEM	DESCRIPTION	P/N	FINISH CODE / DOOR PRICE				
			#10	#20	#81	#99	#89
 DH114	Floor Mount Bottom Center Pivot Assembly	DH145	\$76	N/A	Default Finish is #10 unless otherwise specified  <b>Note: Hardware Finish</b> #10 = Clear #20 = Bronze		
	Bottom Threshold Portion Center Pivot	DH116	\$36	N/A			
	Bottom Door Portion Center Pivot	DH114	\$39.60	N/A			

FIRST CHOICE PARTS							
ITEM	DESCRIPTION	P/N	FINISH CODE / DOOR PRICE				
			#10	#20	#81	#99	#89
	First Choice CVR SS Pinion Gear Stainless Steel	DHC-16001007-SS	\$30	N/A			
	First Choice Panic Dogging Key	DHC-819	\$7	N/A			
	First Choice Connecting Cable for EL Device x 36"	DHC-EL3000-3CAB	\$36	N/A			Default Finish is #10 unless otherwise specified  Note: Hardware Finsh #10 = Clear #20 = Bronze
	First Choice Connecting Cable for EL Device x 36"	DHC-EL3000-3SP	\$43	N/A			
	First Choice 3692 CVR SS Top Strike Kit Stainless Steel	DHC-9038	\$36	N/A			

# Entrances

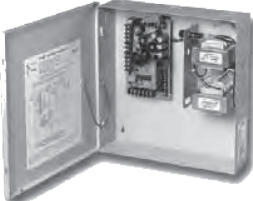
## Standard Loose Hardware

PANIC DEVICES							
ITEM	DESCRIPTION	P/N	FINISH CODE / DOOR PRICE				
			#10	#20	#81	#99	#89
	First Choice - Standard Concealed Vertical Rod Exit Device Hand Reversible	DH369236 Up To 3'-0"	\$349	\$357	Default Finish is #10 unless otherwise specified  Note: Hardware Finish #10 = Clear #20 = Bronze		
		DH369242 Up To 3'-6"	\$300	\$308			
		DH369248 Up To 4'-0"	\$303	\$310			
	First Choice - Standard Concealed Vertical Rod Exit Device Hand Reversible Motorized Electric Retraction Panic	DH369236FLEL Up To 3'-0"	\$1,540	\$1,540			
		DH369242FLEL Up To 3'-6"	\$1,610	\$1,610			
		DH369248FLEL Up To 4'-0"	\$1,680	\$1,680			
	First Choice - Standard RIM Exit Device Non-Handed	DH379236 Up To 3'-0"	\$292	\$299			
		DH379242 Up To 3'-6"	\$295	\$302			
		DH379248 Up To 4'-0"	\$306	\$313			
	Electric Strike For Rim Panic	DH099	\$317	\$317			
	Securitron Electrical Power Transfer (Priced Per Leaf)	DHC-EPT	\$100	\$117			

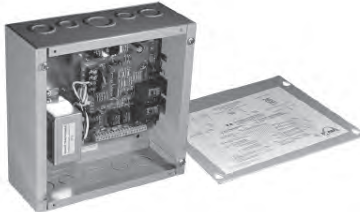
PANIC DEVICES							
ITEM	DESCRIPTION	P/N	FINISH CODE / DOOR PRICE				
			#10	#20	#81	#99	#89
	First Choice PSME1500 Power Supply (Single)	DHC-PSME1500	\$546	N/A			
	First Choice PSME2000 Power Supply (Pair)	DHC-PSME2000	\$779	N/A			
	Jackson Concealed Vertical Rod Exit Device Handed Up To 3'-0" x 7'-0"	DH2086L	\$1,172	\$1,214			
		DH2086R					
	Jackson Concealed Vertical Rod Exit Device Handed Up To 4'-0" x 7'-0"	DH2086L-48	\$1,214	\$1,235			
		DH2086R-48					
	Jackson 2086 Concealed Vertical Rod Exit Device Handed Electric Latch Retraction Up To 4'-0" x 7'-0"	DH2086ELL-48	\$2,302	\$2,407			
	Jackson 2086 Concealed Vertical Rod Exit Device Handed Electric Latch Retraction Up To 4'-0" x 7'-0"	DH2086ELR-48	\$2,302	\$2,407			
	Jackson 2086 Cylinder Mounting Pad	DH073	\$32	\$32			
	Jackson 30-2616 Power Supply	DHC-30-2616	\$1,040	\$N/A			

Default Finish is #10  
unless otherwise  
specified

**Note: Hardware Finish**  
#10 = Clear  
#20 = Bronze

# Entrances

## Standard Loose Hardware

REMOVABLE MULLIONS AND DOOR SWEEPS							
ITEM	DESCRIPTION	P/N	FINISH CODE / DOOR PRICE				
			#10	#20	#81	#99	#89
	First Choice Removable Mullion For Pair of Doors with Rim Exit Devices	DHRM370-7 Up To 7'	\$655	\$680			
		DHRM370-8 Up To 8'	\$670	\$690			
		DHRM370-9 Up To 9'	\$690	\$710			
	Surface Applied Bottom Rail Door Sweep Includes Screws	WS136 Up To 3'	\$11	\$11			
		WS148 Up To 4'	\$14	\$14			

Default Finish is #10 unless otherwise specified

**Note: Hardware Finish**  
 #10 = Clear  
 #20 = Bronze



**STOCK PREFABRICATED THRESHOLDS**

ITEM	DESCRIPTION	LENGTH	HAND	P/N	MILL
 <p>4" x 1/2" Mill Finish Threshold</p>	Standard Butt Hinge Threshold	36"	N/A	TH4-36-AB	\$33
		42"	N/A	TH4-42-AB	\$35
		48"	N/A	TH4-48-AB	\$39
		72"	N/A	TH4-72-J	\$50
		84"	N/A	TH4-84-J	\$55
	Standard Butt Hinge Threshold Panic	36"	RH	TH4-36-AP	\$39
		36"	LH	TH4-36-BP	\$39
		42"	RH	TH4-42-AP	\$42
		42"	LH	TH4-42-BP	\$42
		48"	RH	TH4-48-AP	\$46
		48"	LH	TH4-48-BP	\$46
		72"	N/A	TH4-72-JP	\$55
		84"	N/A	TH4-84-JP	\$61
	Standard Offset Pivot Threshold	36"	RH	TH4-36-C	\$33
		36"	LH	TH4-36-D	\$33
		42"	RH	TH4-42-C	\$35
		42"	LH	TH4-42-D	\$35
		48"	RH	TH4-48-C	\$39
		48"	LH	TH4-48-D	\$39
		72"	N/A	TH4-72-K	\$50
		84"	N/A	TH4-84-K	\$55
	Standard Offset Pivot Threshold Panic	36"	RH	TH4-36-CP	\$39
		36"	LH	TH4-36-DP	\$39
		42"	RH	TH4-42-CP	\$42
		42"	LH	TH4-42-DP	\$42
		48"	RH	TH4-48-CP	\$46
		48"	LH	TH4-48-DP	\$46
		72"	RH	TH4-72-KP	\$55
		72"	LH	TH4-84-KP	\$61
Standard Center Pivot Threshold	36"	N/A	TH4-36-GH	\$44	
	42"	N/A	TH4-42-GH	\$50	
	48"	N/A	TH4-48-GH	\$55	
	72"	N/A	TH4-72-M	\$66	
	84"	N/A	TH4-84-M	\$72	

Page Left Intentionally Blank

**Section B**  
**STOREFRONT SYSTEMS**  
**Table of Contents**

FL200 Storefront System.....	B1
FL300 Storefront System.....	B2
FL300T Thermal Storefront System.....	B3
FS400T Thermal Storefront System.....	B4
Angles, Channels, Flat Bars, & Tubes.....	B5
FL100 Removable Office Partitions.....	B6
FL600 Storefront System.....	B7
FS600T Thermal Storefront System.....	B8
FS600UT Thermal Storefront System.....	B9









Page Left Intentionally Blank

Section B1  
 Table of Contents

**FL200**  
 STOREFRONT SYSTEM  
 1<sup>3</sup>/<sub>4</sub>" X 4<sup>1</sup>/<sub>2</sub>"

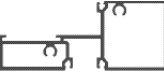
	<i>Page</i>
Standard Framing Extrusions.....	1
Optional Framing Extrusions .....	2-3
Door Framing Extrusions .....	4
Optional Door Extrusions .....	5
Accessories.....	6
Steel Reinforcing.....	7
Glazing Infill Charts and Setting Block/Setting Chair Charts .....	7

Page Left Intentionally Blank





STANDARD FRAMING EXTRUSIONS									
PART DESCRIPTION	PART NO.	PART LENGTH	PCS. PER BOX	FINISH CODE/STOCK LENGTH LIST PRICE					
				#11 CLEAR	#21 BRONZE	#81 WHITE	#2604 POWDER	#2605 POWDER	
 <b>Head/Wall Jamb</b> (Deep Pocket)	FL201	24'	3	\$265	\$289	\$289	\$319	\$357	
 <b>Sill/Optional Head</b> (Deep Pocket)	FL202	24'	4	\$230	\$250	\$250	\$255	\$282	
 <b>Glass Stop</b>	FL203	24'	10	\$65	\$72	\$72	\$123	\$146	
 <b>Shallow Pocket Filler</b>	FL205	24'	10	\$94	\$104	\$104	\$145	\$167	
 <b>Intermediate Horizontal</b>	FL206	24'	3	\$252	\$266	\$266	\$349	\$391	
 <b>Standard Vertical Mullion</b>	FL204	24'	4	\$194	\$212	\$212	\$277	\$318	
 <b>Expansion Male Mullion</b> (Requires VG10 Gasket Mates w/FL211 Expansion Mullion)\	FL210	24'	4	\$182	\$198	\$198	\$255	\$290	
 <b>Expansion Female Mullion</b> (Mates w/FL210 Expansion Mullion)	FL211	24'	4	\$188	\$203	\$203	\$236	\$265	
 <b>Sub-Sill Flashing</b>	FL219	24'	10	\$133	\$145	\$145	\$199	\$227	

Note: Add Finish Code to the Part Number when ordering (Ex: **FL201-11** for Clear Anodized Finish)

# FL200·1<sup>3</sup>/<sub>4</sub>"x4<sup>1</sup>/<sub>2</sub>"





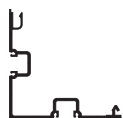
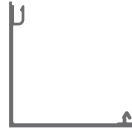
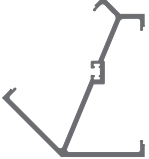

## Non-Thermal Screw-Spline Storefront



OPTIONAL FRAMING EXTRUSIONS								
PART DESCRIPTION	PART NO.	PART LENGTH	PCS. PER BOX	FINISH CODE/STOCK LENGTH LIST PRICE				
				#11 CLEAR	#21 BRONZE	#81 WHITE	#2604 POWDER	#2605 POWDER
 <b>Deep Pocket Filler</b> (Required w/CS135)	FL213	24'	10	\$103	\$112	\$112	\$149	\$173
 <b>Head/Vertical Mullion</b>	FL214	24'	4	\$222	\$241	\$241	\$298	\$339
 <b>Heavy Vertical Mullion</b>	FL216	24'	3	\$271	\$287	\$287	\$355	\$397
 <b>Single Pocket Corner Post Mullion</b>	FL251	24'	4	\$272	\$292	\$292	\$348	\$391
 <b>Double Pocket Corner Post Mullion</b>	FL252	24'	4	\$310	\$334	\$334	\$360	\$399
 <b>90° Corner Post Trim</b>	FL350	24'	4	\$233	\$251	\$251	\$336	\$381
 <b>135° Corner Post Mullion</b> (Mates w/FL213 Filler)	CS135	24'	2	\$374	\$397	\$397	\$446	\$490

Note: Add Finish Code to the Part Number when ordering (Ex: FL201-11 for Clear Anodized Finish)



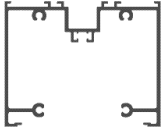







OPTIONAL FRAMING EXTRUSIONS									
PART DESCRIPTION	PART NO.	PART LENGTH	PCS. PER BOX	FINISH CODE/STOCK LENGTH LIST PRICE					
				#11 CLEAR	#21 BRONZE	#81 WHITE	#2604 POWDER	#2605 POWDER	
 <p><b>1/2" Reveal Adapter</b> (Snap fits with Open Back Wall Jambs/Head Members)</p>	<b>CS102</b>	24'	10	\$125	\$136	\$136	\$164	\$187	
 <p><b>Flat Filler</b> Snap fits with Open Back Wall Jambs/Head Members)</p>	<b>CS104</b>	24'	10	\$93	\$101	\$101	\$149	\$173	
 <p><b>1/4" Snap-In Glazing Pocket Filler</b></p>	<b>CS105</b>	21'-5"	12	\$26	\$33	\$33	\$53	\$66	
 <p><b>Interlocking Stop</b> (Snap fits with CS119 Head Expander - Requires VG10 Gasket)</p>	<b>CS118</b>	24'	10	\$55	\$61	\$61	\$118	\$140	
 <p><b>Head Expander</b> (Snap fits with CS118 Head Expander - Requires VG10 Gasket)</p>	<b>CS119</b>	24'	6	\$154	\$168	\$168	\$189	\$213	
 <p><b>Head/Wall Jamb Anchor Clip</b></p>	<b>CS300</b>	24'	2	Mill-00 \$108	N/A	N/A	N/A	N/A	
 <p><b>Bulk Head Base</b> (4 1/2" x 4 1/2" for 1/4" Glazing Requires Two FL203 Glass Stops)</p>	<b>CS453</b>	24'	2	\$437	\$469	\$469	\$479	\$513	

Note: Add Finish Code to the Part Number when ordering (Ex: **FL201-11** for Clear Anodized Finish)







# FL200·1<sup>3</sup>/<sub>4</sub>"x4<sup>1</sup>/<sub>2</sub>"

## Non-Thermal Screw-Spline Storefront



DOOR FRAME EXTRUSIONS									
PART DESCRIPTION	PART NO.	PART LENGTH	PCS. PER BOX	FINISH CODE/STOCK LENGTH LIST PRICE					
				#11 CLEAR	#21 BRONZE	#81 WHITE	#2604 POWDER	#2605 POWDER	
 <b>Door Header for Offset Doors</b> (Requires DS200 Door Stop)	FL207	24'-6"	3	\$318	\$334	\$334	\$455	\$509	
 <b>Door Header for Center Hung Doors</b> (Requires CS112 Cover)	FL208	24'	4	\$223	\$237	\$237	\$326	\$369	
 <b>Open Back Door Jamb for Offset Doors</b> (Requires DS200 Door Stop)	FL209	24'	4	\$215	\$233	\$233	\$298	\$339	
 <b>Tubular Door Header for COC Offset Doors</b> (Requires DS202 Door Stop)	FL212	24'	4	\$248	\$258	\$258	\$429	\$489	
 <b>Open Back Door Jamb Center Hung Doors</b>	FL217	24'	3	\$180	\$194	\$194	\$290	\$335	
 <b>Snap-In Cover for Center Hung Door Header</b> (Mates with FL208 Door Header)	CS112	21'-2"	20	\$98	\$105	\$105	\$155	\$180	
 <b>Snap-In Door Stop for 1/4" Glass</b> (Requires WP200 Weathering)	DS200	16'	20	\$44	\$48	\$48	\$89	\$110	
 <b>Transom Sash Base for 1/4" Glass</b> (Requires FL518 Glass Stop)	CS113	24'	12	\$63	\$70	\$70	\$80	\$90	
 <b>Glass Stop for Transom Sash</b> (Mates with CS113 and CS115 Transom Sash Base)	FL518	24'	12	\$49	\$54	\$54	\$114	\$138	











Note: Add Finish Code to the Part Number when ordering (Ex: **FL201-11** for Clear Anodized Finish)









OPTIONAL DOOR EXTRUSIONS									
PART DESCRIPTION		PART NO.	PART LENGTH	PCS. PER BOX	FINISH CODE/STOCK LENGTH LIST PRICE				
					#11 CLEAR	#21 BRONZE	#81 WHITE	#2604 POWDER	#2605 POWDER
	Door Rail Shoe Base	DB124	24'	8	Mill-00	N/A	N/A	N/A	N/A
					\$38				
	1/16" Door Rail Base Extension	DB123	24'	8	\$96	\$103	\$103	\$154	\$177
	Mid Rail Adapter <small>(Use with D102, 108, or 109)</small>	D113	24'	10	Mill-00	N/A	N/A	N/A	N/A
					\$49				
	4" Muntin or Sidelite Base	D102	16'-0"	4	\$195	\$205	\$205	\$263	\$293
	7 1/2" Muntin or Sidelite Base	D108	16'-0"	4	\$313	\$327	\$327	\$439	\$486
	9 1/2" Muntin or Sidelite Base	D109	16'-0"	4	\$380	\$395	\$395	\$537	\$597
	Door Glass Stop for 1/4" Glazing <small>(Use NG4 Gasket)</small>	DG100	16'-0"	20	\$33	\$41	\$41	\$67	\$80
	Door Glass Stop for 1" Glazing <small>(Use NG415 Gasket)</small>	DG101	16'-0"	18	\$28	\$38	\$38	\$61	\$73

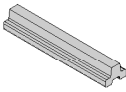
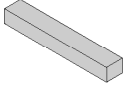

Note: Add Finish Code to the Part Number when ordering (Ex: FL201-11 for Clear Anodized Finish)

# FL200·1<sup>3</sup>/<sub>4</sub>" x 4<sup>1</sup>/<sub>2</sub>"

## Non-Thermal Screw-Spline Storefront

ACCESSORIES			
PART DESCRIPTION	PART NO.	QTY	PRICE PER BOX
 <b>Spline Screw</b> #14 x 1 HHSTS (Assembly Screw)	AS16	100 (AS16-1)	\$17
 <b>#6 x 3/8" PPH</b> <b>Type AB</b> (Attaches End Dams)	AS31	100 (AS31-1)	\$8
 <b>#10-24 x 3/8"</b> <b>UCPFH</b> (Attaching SR101 or SR102 Steel Reinforcing)	AS24	100 (AS24-1)	\$27
 <b>Setting Chair</b> (Two Per Lite Required at Sill Member)	CS100-1	50 (CS100-2)	\$70
 <b>Drill Jig for</b> <b>Screw Spline</b> (Required for Series FL200 Storefront)	DJ200	1	\$202
 <b>End Dam for</b> <b>Sill Flashing</b> (Requires Two AS21 Screws)	ED219-1	20 (ED219-2)	\$36
 <b>EPDM Gasket</b> (Standard Gasket for 1/2" Glazing)	NG1	300 FT. (Per Roll)	\$163
 <b>Heavy Glazing</b> <b>Gasket</b>	NG2	500 FT. (Per Roll)	\$410
 <b>3/8" Glazing</b> <b>Gasket</b>	NG3	250 FT. (Per Roll)	\$158
 <b>Caulking Stop</b> (Used at FL214 Head and Jambs)	NG41S	250 FT. (Per Roll)	\$136

ACCESSORIES			
PART DESCRIPTION	PART NO.	QTY	PRICE PER BOX
 <b>4" Long EPDM</b> <b>Setting Block</b> for 1/2" Glass (Exterior Glazing - Two Per Lite)	SB2	100 (SB2-1)	\$70
 <b>4" Long EPDM</b> <b>Setting Block</b> for Int. Glazing (Horizontal - Two Per Lite)	SB5	100 (SB5-1)	\$82
 <b>Water Diverter</b> (Horizontal - Two Per Lite)	WD200-1	50 (WD200-2)	\$74
 <b>Vinyl Gasket</b> (Standard Weathering Gasket for FL210 and CS118 / CS119)	VG10	250 FT. (VG10-1) (Per Roll)	\$221
 <b>Joint Sealant</b> <b>Tape</b> (1/8" x 1/2" for Sealing Horizontal to Vertical Member Connections)	SM5601	30 FT. (Per Roll)	\$44
 <b>Weathering</b> <b>for D200</b>	WP200	500 FT. (Per Roll)	\$116
 <b>Steel Bracket for</b> <b>Muntin Assembly</b> <b>to Door Stile</b>	TH401	50 (TH401-2)	\$112
 <b>#8 x 3/4" POH</b> <b>TEK Screw</b>	AS7	100 (AS7-1)	\$33
 <b>Caulking Stop</b> (Used at FL214 Head and Jambs)	CS104P-1	10	\$426

STEEL REINFORCING			
PART DESCRIPTION	PART NO.	QUANTITY LENGTH	PRICE
 <b>1<sup>1</sup>/<sub>4</sub>" x 4<sup>3</sup>/<sub>16</sub>" x 10 Ga. Steel Reinforcing</b> (For Standard Vertical Mullions)	SR101	1	\$311
		10'-0"	
 <b>1<sup>1</sup>/<sub>4</sub>" x 4<sup>3</sup>/<sub>16</sub>" x 10 Ga. Steel Reinforcing</b> (For Standard Vertical Mullions)	SR102	1	\$181
		10'-0"	

GLAZING INFILL CHART					
SYSTEM	GLAZING ADAPTER	REGLET WIDTH	INFILL THICKNESS	GASKET COMBINATIONS	
FL200	N/A	5/8"	3/16"	NG2	NG1
			1/4"	NG1	NG1
			5/16"	NG1	NG3
			3/8"	NG3	NG3

SETTING BLOCK AND SETTING CHAIR CHART					
GLASS SIZE	PART DESCRIPTION	PART NO.	GLAZING APPLICATION	SETTING BLOCK PART NO.	SETTING CHAIR PART NO.
1/4"	Sill Member	FL202	Exterior Glazed	SB2	CS100-1
		FL203	Interior Glazed	SB2	CS100-2
1/4"	Intermediate Horizontal	FL206	Exterior Glazed	SB2	Not Required
		FL206	Interior Glazed	SB5	Not Required
1/4"	Bulk Head Base	CS453	Exterior Glazed	SB2	CS100-1
		CS453	Interior Glazed	SB2	CS100-1

Page Left Intentionally Blank

## Section B2 Table of Contents

# FL300







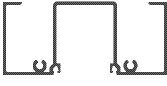
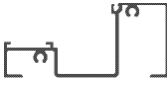

STOREFRONT SYSTEM

2" x 4½"

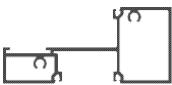
	<i>Page</i>
Standard Framing Extrusions.....	1
Optional Framing Extrusions .....	2-3
Door Framing Extrusions .....	4
Optional Door Extrusions .....	5
Accessories.....	6
Steel Reinforcing.....	7
Glazing Infill Charts and Setting Block/Setting Chair Charts .....	7

Page Left Intentionally Blank







STANDARD FRAMING EXTRUSIONS									
PART DESCRIPTION	PART NO.	PART LENGTH	PCS. PER BOX	FINISH CODE/STOCK LENGTH LIST PRICE					
				#11 CLEAR	#21 BRONZE	#81 WHITE	#2604 POWDER	#2605 POWDER	
 <b>Head/Wall Jamb</b> (Deep Pocket)	<b>FL301</b>	24'	3	\$287	\$311	\$311	\$332	\$369	
 <b>Sill/Optional Head</b> (Deep Pocket)	<b>FL302</b>	24'	4	\$244	\$265	\$265	\$270	\$290	
 <b>Glass Stop</b>	<b>FL303</b>	24'	10	\$65	\$72	\$72	\$123	\$145	
 <b>Shallow Pocket Filler</b>	<b>FL305</b>	24'	10	\$94	\$104	\$104	\$145	\$167	
 <b>Intermediate Horizontal</b>	<b>FL306</b>	24'	3	\$254	\$268	\$268	\$338	\$376	
 <b>Thin Wall Vertical/Wall Jamb</b>	<b>FL304</b>	24'	4	\$213	\$231	\$231	\$286	\$327	
 <b>Expansion Male Mullion</b> (Requires VG10 Gasket Mates w/FL311 Expansion Mullion)	<b>FL310</b>	24'	4	\$213	\$231	\$231	\$310	\$340	
 <b>Expansion Female Mullion</b> (Mates w/FL310 Expansion Mullion)	<b>FL311</b>	24'	4	\$234	\$254	\$254	\$259	\$287	
 <b>Sub-Sill</b> Use ED319-1	<b>FL319</b>	24'	10	\$139	\$150	\$150	\$179	\$202	
 <b>High Performance Sub-Sill</b> Use ED340-1	<b>FL340</b>	24'	10	\$233	\$251	\$251	\$264	\$288	

Note: Add Finish Code to the Part Number when ordering (Ex: **FL201-11** for Clear Anodized Finish)



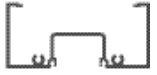

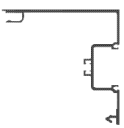
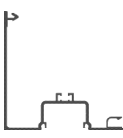
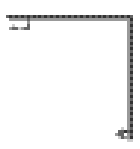

# FL300·2" x 4½"

## Non-Thermal Screw-Spline Storefront

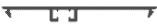

OPTIONAL FRAMING EXTRUSIONS									
PART DESCRIPTION	PART NO.	PART LENGTH	PCS. PER BOX	FINISH CODE/STOCK LENGTH LIST PRICE					
				#11 CLEAR	#21 BRONZE	#81 WHITE	#2604 POWDER	#2605 POWDER	
 <b>Deep Pocket Filler</b> (Required w/CS135)	FL313	24'	10	\$128	\$140	\$140	\$166	\$189	
 <b>Head/Vertical Mullion</b>	FL314	24'	4	\$241	\$262	\$262	\$318	\$357	
 <b>Standard Vertical Mullion</b>	FL315	24'	4	\$237	\$255	\$255	\$311	\$350	
 <b>Heavy Vertical Mullion</b>	FL316	24'	3	\$345	\$364	\$364	\$414	\$454	
 <b>Single Pocket Corner Post Mullion</b>	FL351	24'	4	\$300	\$322	\$322	\$356	\$397	
 <b>Single Pocket Corner Post Mullion</b>	FL353	24'	4	\$297	\$320	\$320	\$353	\$392	
 <b>90° Corner Post Trim</b>	FL350	24'	4	\$233	\$251	\$251	\$336	\$381	
 <b>Axle Interlock</b>	FL320	24'	4	\$173	\$187	\$187	\$204	\$227	
 <b>135° Corner Post Mullion</b> (Mates w/FL313 Expansion Mullion)	CS135	24'	2	\$374	\$397	\$397	\$446	\$490	



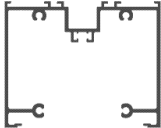



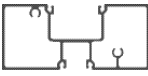

Note: Add Finish Code to the Part Number when ordering (Ex: FL201-11 for Clear Anodized Finish)

OPTIONAL FRAMING EXTRUSIONS								
PART DESCRIPTION	PART NO.	PART LENGTH	PCS. PER BOX	FINISH CODE/STOCK LENGTH LIST PRICE				
				#11 CLEAR	#21 BRONZE	#81 WHITE	#2604 POWDER	#2605 POWDER
 <p><b>½" Reveal Adapter</b> (Snap fits with Open Back Wall Jamb/Head Members)</p>	<b>CS102</b>	24'	10	\$125	\$136	\$136	\$164	\$187
 <p><b>Flat Filler</b> Snap fits with Open Back Wall Jamb/Head Members)</p>	<b>CS104</b>	24'	10	\$93	\$101	\$101	\$149	\$173
 <p><b>1" Snap-In Pocket Filler</b></p>	<b>CS106</b>	21'-6"	12	\$35	\$40	\$40	\$84	\$105
 <p><b>¼" Glass Adapter</b></p>	<b>CS107</b>	24'	12	\$33	\$41	\$41	\$62	\$75
 <p><b>Interlocking Stop</b> (Snap fits with CS119 Head Expander - Requires VG10 Gasket)</p>	<b>CS118</b>	24'	10	\$55	\$61	\$61	\$118	\$140
 <p><b>Head Expander</b> (Snap fits with CS119 Head Expander - Requires VG10 Gasket)</p>	<b>CS119</b>	24'	6	\$154	\$168	\$168	\$189	\$213
 <p><b>Head/Wall Jamb Anchor Clip</b></p>	<b>CS300</b>	24'-3"	2	Mill-00	N/A	N/A	N/A	N/A
				\$108				
 <p><b>Bulk Head Base</b> (4½" x 4¼" for 1" Glazing Requires Two FL303 Glass Stops)</p>	<b>CS453</b>	24'	2	\$437	\$469	\$469	\$479	\$513







Note: Add Finish Code to the Part Number when ordering (Ex: **FL201-11** for Clear Anodized Finish)

# FL300·2" x 4½"

## Non-Thermal Screw-Spline Storefront

DOOR FRAME EXTRUSIONS									
PART DESCRIPTION	PART NO.	PART LENGTH	PCS. PER BOX	FINISH CODE/STOCK LENGTH LIST PRICE					
				#11 CLEAR	#21 BRONZE	#81 WHITE	#2604 POWDER	#2605 POWDER	
 <b>Door Header for Offset Doors</b> (Requires DS200 Door Stop)	FL307	24'-6"	3	\$342	\$357	\$357	\$470	\$523	
 <b>Door Header for Center Hung Doors</b> (Requires CS112 Cover)	FL308	24'	4	\$237	\$251	\$251	\$345	\$390	
 <b>Open Back Door Jamb for Offset Doors</b> (Requires DS200 Door Stop)	FL309	24'	4	\$227	\$245	\$245	\$335	\$377	
 <b>Tubular Door Header for COC Offset Doors</b> (Requires DS202 Door Stop)	FL312	24'	4	\$328	\$339	\$339	\$513	\$577	
 <b>Open Back Door Jamb Center Hung Doors</b>	FL317	24'	3	\$191	\$206	\$206	\$305	\$3452	
 <b>Snap-In Cover for Center Hung Door Header</b> (Mates with FL208 Door Header)	CS112	21'-2"	20	\$98	\$105	\$105	\$155	\$180	
 <b>Snap-In Door Stop for 1" Glass</b> (Requires WP200 Weathering)	DS201	16'	20	\$59	\$66	\$66	\$118	\$142	
 <b>Transom Sash for 1" Glass</b> (Requires FL518 Glass Stop)	CS115	24'	12	\$80	\$87	\$87	\$135	\$157	
 <b>Glass Stop for Transom Sash</b>	FL518	24'	12	\$49	\$54	\$54	\$114	\$138	











Note: Add Finish Code to the Part Number when ordering (Ex: **FL201-11** for Clear Anodized Finish)

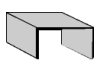







OPTIONAL DOOR EXTRUSIONS									
PART DESCRIPTION		PART NO.	PART LENGTH	PCS. PER BOX	FINISH CODE/STOCK LENGTH LIST PRICE				
					#11 CLEAR	#21 BRONZE	#81 WHITE	#2604 POWDER	#2605 POWDER
	Door Rail Shoe Base	DB124	24'	8	Mill-00	N/A	N/A	N/A	N/A
					\$38				
	1/16" Door Rail Base Extension	DB123	24'	8	\$96	\$103	\$103	\$154	\$177
	Mid Rail Adapter	D113	24"	10	Mill-00	N/A	N/A	N/A	N/A
					\$49				
	4" Muntin or Sidelite Base	D102	16'-0"	4	\$195	\$205	\$205	\$263	\$293
	8" Muntin or Sidelite Base	D108	16'-0"	4	\$313	\$327	\$327	\$439	\$486
	9½" Muntin or Sidelite Base	D109	16'-0"	4	\$380	\$395	\$395	\$537	\$597
	Door Glass Stop for 1/4" Glazing	DG100	16'-0"	20	\$33	\$41	\$41	\$67	\$80
	Door Glass Stop for 1" Glazing	DG101	16'-0"	18	\$28	\$38	\$38	\$61	\$73



Note: Add Finish Code to the Part Number when ordering (Ex: FL201-11 for Clear Anodized Finish)

# FL300·2" x 4½"

## Non-Thermal Screw-Spline Storefront

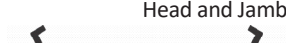
ACCESSORIES			
PART DESCRIPTION	PART NO.	QTY	PRICE PER BOX
 <b>Spline Screw #14 x 1 HHSTS</b> (Assembly Screw)	AS16	100 (AS16-1)	\$17
 <b>#6 x 3/8" PPH Type AB</b> (Attaches End Dams)	AS31	100 (AS21-1)	\$8
 <b>#10-24 x 3/8" UCPFH</b> (Attaching SR101 or SR102 Steel Reinforcing)	AS24	100 (AS24-1)	\$27
 <b>Setting Chair</b> (Two Per Lite Required at Sill Member)	CS101-1	50 (CS101-2)	\$100
 <b>Drill Jig for Screw Spline</b> (Required for Series FL300 Storefront)	DJ300	1	\$218
 <b>End Dam for FL319 Sub Sill</b> (Requires Two AS21 Screws)	ED319-1	20 (ED319-2)	\$36
 <b>End Dam for FL340 High Performance Sub Sill</b> (Requires Two AS21 Screws)	ED340-1	20 (ED340-2)	\$36
 <b>EPDM Gasket</b> (Standard Gasket for 1/2" Glazing)	NG1	300 FT. (Per Roll)	\$163
 <b>Heavy Glazing Gasket</b>	NG2	500 FT. (Per Roll)	\$410
 <b>3/8" Glazing Gasket</b>	NG3	250 FT. (Per Roll)	\$158
 <b>HD</b>	NG41S	250 FT. (Per Roll)	\$136

ACCESSORIES			
PART DESCRIPTION	PART NO.	QTY	PRICE PER BOX
 <b>4" Long EPDM Setting Block for 1" Glass</b> (Exterior Glazing - Two Per Lite)	SB3	100 (SB3-1)	\$116
 <b>4" Long EPDM Setting Block for Int. Glazing</b> (Horizontal - Two Per Lite)	SB4	100 (SB4-1)	\$318
 <b>Water Diverter</b> (Horizontal - Two Per Lite)	WD300-1	50 (WD300-2)	\$74
 <b>Vinyl Gasket</b> (Standard Weathering Gasket for FL210 and CS118 / CS119)	VG10	250 FT. (VG10-1) (Per Roll)	\$221
 <b>Joint Sealant Tape</b> (1/4" x 1/2" for Sealing Horizontal to Vertical Member Connections)	SM5601	30 FT. (Per Roll)	\$44
 <b>Weathering for D200</b>	WP200	500 FT. (Per Roll)	\$116
 <b>Steel Bracket for Muntin Assembly to Door Stile</b>	TH401	50 (TH401-2)	\$112
 <b>#8 x 3/4" POH TEK Screw</b>	AS7	100 (AS7-1)	\$33
 <b>Caulking Stop</b> (Used at FL314 Head and Jambs)	CS104P-1	10	\$426
 <b>Caulking Stop</b> (Used at FL301/ Head and Jambs)	FL301P-1	10	\$539

STEEL REINFORCING			
PART DESCRIPTION	PART NO.	QUANTITY LENGTH	PRICE
 <b>1¼" x 4¾" x 10 Ga. Steel Reinforcing</b> (For Standard Vertical Mullions)	SR101	1	\$311
		10'-0"	
 <b>1¼" x 4¾" x 10 Ga. Steel Reinforcing</b> (For Standard Vertical Mullions)	SR102	1	\$181
		10'-0"	

GLAZING INFILL CHART					
SYSTEM	GLAZING ADAPTER	REGLET WIDTH	INFILL THICKNESS	GASKET COMBINATIONS	
FL300	N/A	1⅜"	⅞"	NG2	NG2
			15/16"	NG2	NG1
			1"	NG1	NG1
			1⅛"	NG1	NG3
			1⅞"	NG3	NG3

SETTING BLOCK AND SETTING CHAIR CHART					
GLASS SIZE	PART DESCRIPTION	PART NO.	GLAZING APPLICATION	SETTING BLOCK PART NO.	SETTING CHAIR PART NO.
1"	Sill Member	FL302	Exterior Glazed	SB3	CS101-1
		FL303	Interior Glazed	SB4	CS101-1
1"	Intermediate Horizontal	FL306	Exterior Glazed	SB3	Not Required
		FL306	Interior Glazed	SB4	Not Required
1"	Bulk Head Base	CS453	Exterior Glazed	SB3	CS101-1
		CS453	Interior Glazed	SB4	CS101-1

Page Left Intentionally Blank













## Section B3 Table of Contents

### **FL300T** THERMAL STOREFRONT SYSTEM

2" x 4½"

	<i>Page</i>
Standard Framing Extrusions.....	1
Optional Framing Extrusions .....	2-3
Door Framing Extrusions .....	4
Optional Door Extrusions .....	5
Accessories.....	6
Steel Reinforcing.....	7
Glazing Infill Charts and Setting Block/Setting Chair Charts .....	7

Page Left Intentionally Blank





STANDARD FRAMING EXTRUSIONS									
PART DESCRIPTION	PART NO.	PART LENGTH	PCS. PER BOX	FINISH CODE/STOCK LENGTH LIST PRICE					
				#11 CLEAR	#21 BRONZE	#81 WHITE	#2604 POWDER	#2605 POWDER	
 <b>Head/Wall Jamb</b> (Deep Pocket)	FL321T	24'	3	\$332	\$357	\$357	\$373	\$411	
 <b>Sill/Optional Head</b>	FL322T	24'	4	\$252	\$272	\$272	\$277	\$304	
 <b>Glass Stop</b>	FL303	24'	10	\$65	\$72	\$72	\$123	\$145	
 <b>Shallow Pocket Filler</b>	FL325T	24'	10	\$145	\$156	\$156	\$189	\$212	
 <b>Intermediate Horizontal</b>	FL326T	24'	3	\$297	\$313	\$313	\$377	\$416	
 <b>Standard Vertical Mullion</b>	FL334T	24'	4	\$290	\$314	\$314	\$351	\$392	
 <b>Expansion Male Mullion</b> (Requires VG10 Gasket)	FL310T	24'	4	\$247	\$265	\$265	\$344	\$375	
 <b>Expansion Female Mullion</b> (Mates w/FL310 Expansion Mullion)	FL311T	24'	4	\$268	\$289	\$289	\$294	\$322	
 <b>Sub-Sill</b> Use ED319-1	FL339T	24'	10	\$216	\$231	\$231	\$243	\$266	
 <b>High Performance Sub-Sill</b> Use ED340-1	FL340T	24'	10	\$266	\$285	\$285	\$295	\$313	

Note: Add Finish Code to the Part Number when ordering (Ex: **FL321T-11** for Clear Anodized Finish)





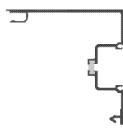
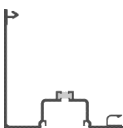
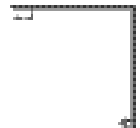

# FL300T·2" x 4½"

## Thermal Screw-Spline Storefront

### OPTIONAL FRAMING EXTRUSIONS

PART DESCRIPTION	PART NO.	PART LENGTH	PCS. PER BOX	FINISH CODE/STOCK LENGTH LIST PRICE				
				#11 CLEAR	#21 BRONZE	#81 WHITE	#2604 POWDER	#2605 POWDER
 <b>Rotating Mullion</b> (Use with FL320T)	FL331T	24'	10	\$264	\$283	\$283	\$312	\$345
 <b>Deep Pocket Filler</b> (Required w/CS135)	FL313T	24'	10	\$161	\$174	\$174	\$200	\$223
 <b>Heavy Vertical Mullion</b>	FL316T	24'	3	\$378	\$399	\$399	\$448	\$489
 <b>Single Pocket Corner Post Mullion</b>	FL351T	24'	4	\$334	\$357	\$357	\$391	\$430
 <b>Single Pocket Corner Post Mullion</b>	FL353T	24'	4	\$331	\$353	\$353	\$387	\$427
 <b>90° Corner Post Trim</b>	FL350	24'	4	\$233	\$251	\$251	\$366	\$381
 <b>Axle Interlock</b> (Use with FL331T)	FL320T	24'	4	\$206	\$222	\$222	\$239	\$267



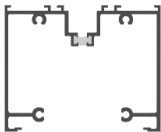



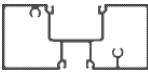

Note: Add Finish Code to the Part Number when ordering (Ex: FL321T-11 for Clear Anodized Finish)

OPTIONAL FRAMING EXTRUSIONS								
PART DESCRIPTION	PART NO.	PART LENGTH	PCS. PER BOX	FINISH CODE/STOCK LENGTH LIST PRICE				
				#11 CLEAR	#21 BRONZE	#81 WHITE	#2604 POWDER	#2605 POWDER
 <p><b>135° Corner Post Mullion</b> (Use w/FL313T Fillers)</p>	CS135T	24'	2	\$408	\$430	\$430	\$480	\$525
 <p><b>½" Reveal Adapter</b> (Snap fits with Open Back Wall Jamb/Head Members)</p>	CS102T	24'	10	\$159	\$171	\$171	\$199	\$221
 <p><b>Flat Filler</b> Snap fits with Open Back Wall Jamb/Head Members)</p>	CS104T	24'	10	\$126	\$135	\$135	\$183	\$206
 <p><b>1" Snap-In Glazing Pocket Filler</b></p>	CS106	21'-5"	12	\$35	\$40	\$40	\$84	\$105
 <p><b>Interlocking Stop</b> (Snap fits with CS118 interlocking stop)</p>	CS118	24'	10	\$55	\$61	\$61	\$118	\$140
 <p><b>Head Expander</b> (Snap fits with CS119 Head Expander - Requires VG10 Gasket)</p>	CS119T	24'	6	\$189	\$202	\$202	\$224	\$246
 <p><b>Head/Wall Jamb Anchor Clip</b></p>	CS300T	24'-3"	2	Mill-00	N/A	N/A	N/A	N/A
				\$142				
 <p><b>Bulk Head Base</b> (4½" x 4½" for 1" Glazing Requires Two FL303 Glass Stops)</p>	CS453T	24'	2	\$471	\$503	\$503	\$513	\$548







Note: Add Finish Code to the Part Number when ordering (Ex: **FL321T-11** for Clear Anodized Finish)

# FL300T·2" x 4½"

## Thermal Screw-Spline Storefront

DOOR FRAME EXTRUSIONS									
PART DESCRIPTION	PART NO.	PART LENGTH	PCS. PER BOX	FINISH CODE/STOCK LENGTH LIST PRICE					
				#11 CLEAR	#21 BRONZE	#81 WHITE	#2604 POWDER	#2605 POWDER	
 <b>Door Header for Offset Doors</b> (Requires DS200 Door Stop)	FL307	24'	3	\$342	\$357	\$357	\$470	\$523	
 <b>Door Header for Center Hung Doors</b> (Requires CS112 Cover)	FL308	24'	4	\$237	\$251	\$251	\$345	\$390	
 <b>Open Back Door Jamb for Offset Doors</b> (Requires DS200 Door Stop)	FL309	24'	4	\$227	\$245	\$245	\$335	\$377	
 <b>Tubular Door Header for COC Offset Doors</b> (Requires DS202 Door Stop)	FL312	24'	4	\$328	\$339	\$339	\$513	\$577	
 <b>Open Back Door Jamb Center Hung Doors</b>	FL317	24'	3	\$191	\$206	\$206	\$305	\$352	
 <b>Snap-In Cover for Center Hung Door Header</b> (Mates with FL208 Door Header)	CS112	16'	20	\$98	\$105	\$105	\$155	\$180	
 <b>Snap-In Door Stop for 1" Glass</b> (Requires WP200 Weathering)	DS201	16'	20	\$59	\$66	\$66	\$118	\$142	
 <b>Transom Sash for 1" Glass</b> (Requires FL518 Glass Stop)	CS115	24'	12	\$80	\$87	\$87	\$135	\$157	
 <b>Glass Stop for Transom Sash</b>	FL518	24'	12	\$49	\$54	\$54	\$114	\$138	











Note: Add Finish Code to the Part Number when ordering (Ex: FL321T-11 for Clear Anodized Finish)









OPTIONAL DOOR EXTRUSIONS									
PART DESCRIPTION	PART NO.	PART LENGTH	PCS. PER BOX	FINISH CODE/STOCK LENGTH LIST PRICE					
				#11 CLEAR	#21 BRONZE	#81 WHITE	#2604 POWDER	#2605 POWDER	
 <b>Door Rail Shoe Base</b>	<b>DB124</b>	24'-3"	8	Mill-00	N/A	N/A	N/A	N/A	N/A
				\$38					
 <b>1/16" Door Rail Base Extension</b>	<b>DB123</b>	24'-3"	8	\$96	\$103	\$103	\$154	\$177	
 <b>Mid Rail Adapter</b>	<b>D113</b>	19'-9"	10	Mill-00	N/A	N/A	N/A	N/A	N/A
				\$49					
	<b>4" Muntin or Sidelite Base</b>	<b>D102</b>	16'	4	\$195	\$205	\$205	\$263	\$293
	<b>7-1/2" Muntin or Sidelite Base</b>	<b>D108</b>	16'	4	\$313	\$327	\$327	\$439	\$486
	<b>9-1/2" Muntin or Sidelite Base</b>	<b>D109</b>	16'	4	\$380	\$395	\$395	\$537	\$597
 <b>Door Glass Stop for 1/4" Glazing</b> (Use NG4 Gasket)	<b>DG100</b>	16'	20	\$33	\$41	\$41	\$67	\$80	
 <b>Door Glass Stop for 1" Glazing</b> (Use NG41S Gasket)	<b>DG101</b>	16'	18	\$28	\$38	\$38	\$61	\$73	

Note: Add Finish Code to the Part Number when ordering (Ex: **FL321T-11** for Clear Anodized Finish)



# FL300T·2" x 4½"

## Thermal Screw-Spline Storefront

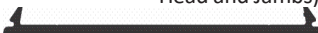
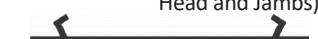
ACCESSORIES			
PART DESCRIPTION	PART NO.	QTY	PRICE PER BOX
 <b>Spline Screw</b> #14 x 1 HHSTS (Assembly Screw)	AS16	100 (AS16-1)	\$17
 <b>#6 x ¾" PPH</b> <b>Type AB</b> (Attaches End Dams)	AS31	100 (AS31-1)	\$8
 <b>#10-24 x ¾"</b> <b>UCPFH</b> (Attaching SR101 or SR102 Steel Reinforcing)	AS24	100 (AS24-1)	\$27
 <b>Setting Chair</b> (Two Per Lite Required at Sill Member)	CS101-1	50 (CS101-2)	\$100
 <b>Drill Jig for</b> <b>Screw Spline</b> (Required for Series FL300 Storefront)	DJ300	1	\$218
 <b>End Dam for</b> <b>FL319 Sub Sill</b> (Requires Two AS21 Screws)	ED319-1	20 (ED319-2)	\$36
 <b>End Dam for</b> <b>FL340T High Performance</b> <b>Sub Sill</b> (Requires Two AS21 Screws)	ED340-1	20 (ED340-2)	\$36
 <b>EPDM Gasket</b> (Standard Gasket for ¼" Glazing)	NG1	300 FT. (Per Roll)	\$163
 <b>Heavy Glazing</b> <b>Gasket</b>	NG2	500 FT. (Per Roll)	\$410
 <b>¾" Glazing</b> <b>Gasket</b>	NG3	250 FT. (Per Roll)	\$158

ACCESSORIES			
PART DESCRIPTION	PART NO.	QTY	PRICE PER BOX
 <b>4" Long EPDM</b> <b>Setting Block</b> <b>for 1" Glass</b> (Exterior Glazing - Two Per Lite)	SB3	100 (SB3-1)	\$116
 <b>4" Long EPDM</b> <b>Setting Block</b> <b>for Int. Glazing</b> (Horizontal - Two Per Lite)	SB4	100 (SB4-1)	\$318
 <b>Water Diverter</b> (Horizontal - Two Per Lite)	WD300-1	50 (WD300-2)	\$74
 <b>Vinyl Gasket</b> (Standard Weathering Gasket for FL210 and CS118 / CS119)	VG10	250 FT. (VG10-1) (Per Roll)	\$221
 <b>Joint Sealant</b> <b>Tape</b> (½" x ½" for Sealing Horizontal to Vertical Member Connections)	SM5601	30 FT. (Per Roll)	\$44
 <b>Weathering</b> <b>for D200</b>	WP200	500 FT. (Per Roll)	\$116
 <b>Steel Bracket for</b> <b>Muntin Assembly</b> <b>to Door Stile</b>	TH401	50 (TH401-2)	\$112
 <b>#8 x ¾" POH</b> <b>TEK Screw</b>	AS7	100 (AS7-1)	\$33
 <b>Caulking Stop</b> (Used at FL334T Head and Jambs)	CS104P-1	10	\$426
 <b>Caulking Stop</b> (Used at FL321T Head and Jambs)	FL301P-1	10	\$539



STEEL REINFORCING			
PART DESCRIPTION	PART NO.	QUANTITY LENGTH	PRICE
 <b>1¼" x 4¾" x 10 Ga. Steel Reinforcing</b> (For Standard Vertical Mullions)	SR101	1	\$311
		10'-0"	
 <b>1¼" x 4¾" x 10 Ga. Steel Reinforcing</b> (For Standard Vertical Mullions)	SR102	1	\$181
		10'-0"	

GLAZING INFILL CHART					
SYSTEM	GLAZING ADAPTER	REGLET WIDTH	INFILL THICKNESS	GASKET COMBINATIONS	
FL300T	N/A	1⅜"	⅞"	NG2	NG2
			15/16"	NG2	NG1
			1"	NG1	NG1
			1⅛"	NG1	NG3
			1⅞"	NG3	NG3

SETTING BLOCK AND SETTING CHAIR CHART					
GLASS SIZE	PART DESCRIPTION	PART NO.	GLAZING APPLICATION	SETTING BLOCK PART NO.	SETTING CHAIR PART NO.
1"	Sill Member	FL322T	Exterior Glazed	SB3	CS101-1
		FL303	Interior Glazed	SB4	CS101-1
1"	Intermediate Horizontal	FL326T	Exterior Glazed	SB3	Not Required
		FL306	Interior Glazed	SB4	Not Required
1"	Bulk Head Base	CS453T	Exterior Glazed	SB3	CS101-1
		CS453T	Interior Glazed	SB4	CS101-1

Page Left Intentionally Blank











Section B4  
Table of Contents

**FS400T**  
THERMAL STOREFRONT SYSTEM

2" x 4½"  
Front Set

	<i>Page</i>
Standard Framing Extrusions Exterior Glazed System .....	1
Standard Framing Extrusions Interior Glazed System .....	2
Accessories .....	3
Steel Reinforcing.....	4
Glazing Infill Charts and Setting Block/Setting Chair Charts .....	4

Page Left Intentionally Blank

STANDARD FRAMING EXTRUSIONS - EXTERIOR GLAZED SYSTEM									
PART DESCRIPTION	PART NO.	PART LENGTH	PCS. PER BOX	FINISH CODE/STOCK LENGTH LIST PRICE					
				#11 CLEAR	#21 BRONZE	#81 WHITE	#2604 POWDER	#2605 POWDER	
 <b>Head Exterior Glazed</b>	FS402T Thermal	24'	4	\$297	\$320	\$320	\$342	\$370	
 <b>Sill Exterior Glazed</b> (Use CS403 Stop)	FS409T Thermal	24'	4	\$272	\$293	\$273	\$317	\$340	
 <b>Glass Stop Exterior Glaze</b>	CS403	24'	12	\$38	\$473	\$47	\$107	\$128	
 <b>Flat Filler</b>	FS405	24'	10	\$54	\$59	\$59	\$118	\$140	
 <b>Intermediate Horizontal Exterior Glazed</b> (Use CS403 Stop)	FS408T Thermal	24'	4	\$292	\$313	\$313	\$326	\$359	
 <b>Wall Jamb</b>	FS407T Thermal	24'	3	\$261	\$280	\$280	\$315	\$352	
 <b>Standard Vertical Mullion</b>	FS404T Thermal	24'	4	\$278	\$300	\$300	\$332	\$369	
 <b>Expansion Male Mullion</b> Mates with FS411T	FS410T Thermal	24'	4	\$184	\$196	\$196	\$217	\$240	
 <b>Expansion Female Mullion</b> (Use VG10 Gasket) Mates with FS410T	FS411T Thermal	24'	4	\$259	\$278	\$278	\$312	\$349	
 <b>Sub-Sill Flashin</b>	FL339T Thermal Thermal	24'	10	\$216	\$231	\$231	\$243	\$266	











Note: Add Finish Code to the Part Number when ordering (Ex: **FS401T-11** for Clear Anodized Finish)

# FS400T·2" x 4½"









## Thermal Screw-Spline Storefront



### STANDARD FRAMING EXTRUSIONS - INTERIOR GLAZED SYSTEM

PART DESCRIPTION	PART NO.	PART LENGTH	PCS. PER BOX	FINISH CODE/STOCK LENGTH LIST PRICE				
				#11 CLEAR	#21 BRONZE	#81 WHITE	#2604 POWDER	#2605 POWDER
 <b>Head Interior Glazed</b> (Use with FS403 Stop)	FS401T Thermal	24'	3	\$251	\$268	\$268	\$285	\$329
 <b>Sill Interior Glazed</b>	FS402T Thermal	24'	4	\$297	\$320	\$320	\$342	\$370
 <b>Glass Stop Interior Glazed</b>	FS403	24'	10	\$94	\$104	\$104	\$145	\$166
 <b>Flat Filler</b>	FS405	24'	10	\$54	\$59	\$59	\$118	\$140
 <b>Intermediate Horizontal Interior Glazed</b> (Use SB12 Setting Block and FS403 Stop)	FS406T Thermal	24'	3	\$297	\$310	\$310	\$352	\$383
 <b>Wall Jamb</b>	FS407T Thermal	24'	3	\$261	\$280	\$280	\$315	\$352
 <b>Standard Vertical Mullion</b>	FS404T Thermal	24'	4	\$278	\$300	\$300	\$332	\$369
 <b>Expansion Male Mullion</b> Mates with FS411T	FS410T Thermal	24'	4	\$184	\$196	\$196	\$217	\$240
 <b>Expansion Female Mullion</b> (Mates w/FS410T Expansion Mullion) (Use VG10 Gasket)	FS411T Thermal	24'	4	\$259	\$278	\$278	\$312	\$349
 <b>Sub-Sill Flashing</b>	FL339T Thermal	24'	10	\$216	\$231	\$231	\$243	\$266









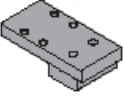

Note: Add Finish Code to the Part Number when ordering (Ex: FL401T-11 for Clear Anodized Finish)

DOOR FRAMING EXTRUSIONS									
PART DESCRIPTION	PART NO.	PART LENGTH	PCS. PER BOX	FINISH CODE/STOCK LENGTH LIST PRICE					
				#11 CLEAR	#21 BRONZE	#81 WHITE	#2604 POWDER	#2605 POWDER	
 Frame Jamb / Header / Transom Bar for Surface Mount Closer (11 & 21 Finish)	FS419	24'	2	\$313	\$327	\$327	\$401	\$446	
 Flat Filler (11 & 21 Finish)	FS405	24'	10	\$54	\$59	\$59	\$118	\$140	
 Transom Sash (Use CS111 Glass Stop)	CS110	24'	12	\$41	\$47	\$47	\$65	\$78	
 Transom Glass Stop (Use NG1)	CS111	24'	12	\$34	\$42	\$42	\$84	\$105	
 Clip Applied Door Stop (Use WP200 Pile with DH-MC175 Clip)	DS158	24'	10	\$51	\$56	\$56	\$116	\$138	
 Transom Header COC Double Acting	FL308	24'	4	\$237	\$251	\$251	\$345	\$390	
 Transom Header Filler	CS112	24'	20	\$98	\$105	\$105	\$155	\$180	
 Door Header/ Transom Bar (11 & 21 Finish)	FL312	24'	4	\$328	\$339	\$339	\$513	\$577	
 Door Stop (Use with FL312) (Use WP200 Pile)	DS202	24'	5	\$110	\$118	\$118	\$190	\$224	

Note: Add Finish Code to the Part Number when ordering (Ex: FL401T-11 for Clear Anodized Finish)

# FS400T·2" x 4½"

## Thermal Screw-Spline Storefront

ACCESSORIES			
PART DESCRIPTION	PART NO.	QUANTITY	PRICE PER BOX
 <b>Spline Screw</b> #14 x 1 HHSTS (Assembly Screw)	AS16	100 (AS16-1)	\$17
 <b>#6 x ¾" PPH</b> <b>Type AB</b> (Attaches End Dams)	AS31	100 (AS31-1)	\$8
 <b>Water Diverter</b> (Use at Intermediate Horizontals)	WD300-1	50 (WD300-2)	\$74
 <b>Drill Jig for</b> <b>Screw Spline</b> (Required for Series FS400T Storefront)	DJ401	1	\$226
 <b>End Dam for</b> <b>Sub Sill Flashing</b>	ED319-1	20 (ED319-2)	\$36
 <b>EPDM Gasket</b>	NG1	300 FT. (Per Roll)	\$163
 <b>Setting Block</b>	SB3	100 (SB3-1)	\$116
 <b>Setting Block</b> (Intermediate Horizontal Inside Glaze)	SB12	100 (SB12-1)	\$59
 <b>Expansion Mullion</b> <b>Gasket</b> (Use with FS411T)	VG10	250 FT. (VG10-1) (Per Roll)	\$221
 <b>Joint Sealant</b> <b>Tape</b> (¼" x ½" for Sealing Horizontal to Vertical Member Connections)	SM5601	30 FT. (Per Roll)	\$44
 <b>Screw</b> (Use with DH-MC175 Clip)	AS7	100	\$33
 <b>Weather Stripping</b>	WP200	500 FT.	\$116

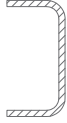

STEEL REINFORCING			
PART DESCRIPTION	PART NO.	QUANTITY	PRICE
 <b>2½" x 1¼" x 10 Ga. Steel Reinforcing</b> (For Standard Vertical Mullions)	SR404	1	\$215
		10'-0"	

GLAZING INFILL CHART					
SYSTEM	GLAZING ADAPTER	REGLET WIDTH	INFILL THICKNESS	GASKET COMBINATIONS	
FS400T	N/A	1¾"	⅞"	NG2	NG2
			15/16"	NG2	NG1
			1"	NG1	NG1

SETTING BLOCK AND SETTING CHAIR CHART					
GLASS SIZE	PART DESCRIPTION	PART NO.	GLAZING APPLICATION	SETTING BLOCK PART NO.	SETTING CHAIR PART NO.
1"	Sill Member	FS409	Exterior Glazed	SB3	Not Required
		FS402	Interior Glazed	SB3	Not Required
1"	Intermediate Horizontal	FS408	Exterior Glazed	SB3	Not Required
		FS406	Interior Glazed	SB12	Not Required











Page Left Intentionally Blank

## Section B5 Table of Contents

### Angles, Channels, Flat Bars, and Tubes

	<i>Page</i>
MISC PARTS - Angles, Channels, Bars, and Tubes .....	1

Page Left Intentionally Blank

STANDARD FRAMING EXTRUSIONS								
PART DESCRIPTION	PART NO.	PART LENGTH	PCS. PER BOX	FINISH CODE/STOCK LENGTH LIST PRICE				
				#11 CLEAR	#21 BRONZE	#81 WHITE	#2604 POWDER	#2605 POWDER
 1" x 1" x 1/8" Angle	A100	21'	12	\$61	\$70			
 1 1/2" x 1 1/2" x 1/8" Angle	A150	21'	12	\$91	\$98			
 1 1/2" x 1" x 1/8" Angle	A151	21'	12	\$76	\$84			
 1 3/4" x 1 3/4" x 1/8" Angle	A175	21'	12	\$107	\$114			
 1/2" x 1/2" Bar	B1	21'	12	\$59	\$73			
 5/16" x 2" Bar	B2	21'	12	\$135	\$146			
 1/2" x 1 1/2" Bar	B3	21'	12	\$171	\$181			
 1" x 1" x 1/8" Channel	CH100	21'	12	\$87	\$94			
 1" x 1" x 1/8" Tube	H100	21'	12	\$114	\$119			
 1 3/4" x 1 3/4" x 7/64" Tube	H175	21'	12	\$181	\$192			
 2" x 2" x 1/8" Tube	H200	21'	12	\$227	\$234			

Default Finish is #11 unless otherwise specified

Note: Add Finish Code to the Part Number when ordering (Ex: A100-11 for Clear Anodized Finish)

Page Left Intentionally Blank

## Section B6 Table of Contents

# FL100





REMOVABLE OFFICE PARTITIONS

1<sup>3</sup>/<sub>8</sub>" X 2<sup>1</sup>/<sub>2</sub>"

	<i>Page</i>
Standard Framing Extrusions.....	1
Optional Framing Extrusions .....	3
Door Framing Extrusions .....	5
Accessories .....	7



Page Left Intentionally Blank



STANDARD FRAMING EXTRUSIONS									
PART DESCRIPTION	PART NO.	PART LENGTH	PCS. PER BOX	FINISH CODE/STOCK LENGTH LIST PRICE					
				#11 CLEAR	#21 BRONZE	#81 WHITE	#2604 POWDER	#2605 POWDER	
 <p>Sill/Head/Intermediate Horizontal</p>	FL102	24'	4	\$149	\$161	\$161	\$190	NA	
 <p>Glass Stop</p>	FL103	24'	10	\$47	\$52	\$52	\$96	NA	
 <p>Shallow Pocket Filler</p>	FL105	24'	10	\$77	\$86	\$86	\$144	NA	
 <p>Standard Vertical Mullion</p>	FL104	24'	4	\$174	\$189	\$189	\$220	NA	

Note: Add Finish Code to the Part Number when ordering (Ex: **FL104-11** for Clear Anodized Finish)

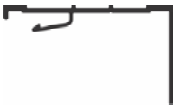
Page Left Intentionally Blank

OPTIONAL FRAMING EXTRUSIONS									
PART DESCRIPTION	PART NO.	PART LENGTH	PCS. PER BOX	FINISH CODE/STOCK LENGTH LIST PRICE					
				#11 CLEAR	#21 BRONZE	#81 WHITE	#2604 POWDER	#2605 POWDER	
 <b>Interlocking Stop</b> (Snap fits with CS019 Head Expander - Requires VG10 Gasket)	<b>CS018</b>	24'	10	\$49	\$55	\$55	\$98	NA	
 <b>Head Expander</b> (Snap fits with CS018 Head Expander - Requires VG10 Gasket)	<b>CS019</b>	24'	6	\$111	\$121	\$121	\$166	NA	
 <b>Wall Cover 4 <sup>3</sup>/<sub>8</sub> "</b>	<b>FL155</b>	24'	4	\$264	\$285	\$285	\$369	NA	
 <b>Wall Cover 4 <sup>7</sup>/<sub>8</sub> "</b>	<b>FL157</b>	24'	4	\$271	\$292	\$292	\$372	NA	



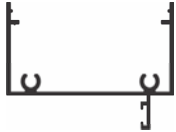
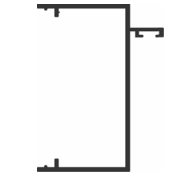
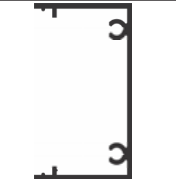

Note: Add Finish Code to the Part Number when ordering (Ex: **FL157-11** for Clear Anodized Finish)

Page Left Intentionally Blank

DOOR FRAME EXTRUSIONS								
PART DESCRIPTION	PART NO.	PART LENGTH	PCS. PER BOX	FINISH CODE/STOCK LENGTH LIST PRICE				
				#11 CLEAR	#21 BRONZE	#81 WHITE	#2604 POWDER	#2605 POWDER
 Door Header	FL107	24'	3	\$154	\$168	\$168	\$252	NA
 Door Jamb	FL109	24'	4	\$132	\$145	\$145	\$238	NA
 Door Jamb / Header Center Hung Doors	FL117	24'	3	\$140	\$153	\$153	\$217	NA

Note: Add Finish Code to the Part Number when ordering (Ex: FL117-11 for Clear Anodized Finish)

Page Left Intentionally Blank

ACCESSORIES			
PART DESCRIPTION	PART NO.	QTY	PRICE PER BOX
 <p><b>Spline Screw</b>  <b>#8 x 1 PHSTS</b>            (Assembly Screw)</p>	<b>AS62</b>	100 (AS62-1)	\$35
 <p><b>Glazing Gasket</b>  <b>3/8 Infill</b></p>	<b>NG1</b>	300 FT. (Per Roll)	\$163
 <p><b>Glazing Gasket</b>  <b>1/4 Infill</b></p>	<b>NG2</b>	500 FT. (Per Roll)	\$410
 <p><b>Glazing Gasket</b>  <b>1/2 Infill</b></p>	<b>NG3</b>	250 FT. (Per Roll)	\$158
 <p><b>4" Long EPDM</b>  <b>Setting Block</b>  <b>for 1/4" Glass</b>            (Exterior Glazing -            Two Per Lite)</p>	<b>SB10</b>	100 (SB10-1)	\$236

Page Left Intentionally Blank









Section B7  
Table of Contents

**FL600**  
STOREFRONT SYSTEM

2¼" x 6"

	<i>Page</i>
Standard Framing Extrusions.....	1
Optional Framing Extrusions .....	2
Door Framing Extrusions .....	3
Optional Door Extrusions .....	4
Accessories .....	5

Page Left Intentionally Blank



STANDARD FRAMING EXTRUSIONS									
PART DESCRIPTION	PART NO.	PART LENGTH	PCS. PER BOX	FINISH CODE/STOCK LENGTH LIST PRICE					
				#11 CLEAR	#21 BRONZE	#81 WHITE	#2604 POWDER	#2605 POWDER	
 <p><b>Head / Vertical / Jamb</b></p>	<b>FL634</b>	24'	4	\$418	\$450	\$450	\$511	\$562	
 <p><b>Sill / Intermediate Horizontal</b></p>	<b>FL626</b>	24'	3	\$478	\$497	\$497	\$613	\$667	
 <p><b>Glass Stop</b></p>	<b>FL303</b>	24'	10	\$65	\$72	\$72	\$123	\$145	
 <p><b>Shallow Pocket Filler</b></p>	<b>FL625</b>	24'	10	\$206	\$224	\$224	\$254	\$280	
 <p><b>Expansion Mullion</b> (Requires VG10 Gasket)</p>	<b>FL610</b>	24'	4	\$331	\$357	\$357	\$419	\$464	
 <p><b>Expansion Female Mullion</b> (Mates w/FL610 Expansion Mullion)</p>	<b>FL611</b>	24'	4	\$371	\$401	\$401	\$477	\$527	
 <p><b>Sub-Sill Flashing</b></p>	<b>FL639</b>	24'	10	\$343	\$370	\$370	\$380	\$413	

Note: Add Finish Code to the Part Number when ordering (Ex: **FL610T-11** for Clear Anodized Finish)







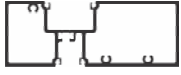

# FL600·2¼" x 6"

## Screw-Spline Storefront

### OPTIONAL FRAMING EXTRUSIONS

PART DESCRIPTION	PART NO.	PART LENGTH	PCS. PER BOX	FINISH CODE/STOCK LENGTH LIST PRICE				
				#11 CLEAR	#21 BRONZE	#81 WHITE	#2604 POWDER	#2605 POWDER
 <p><b>Flat Filler</b> Snap fits with Open Back Wall Jamb/Head Members)</p>	<b>CS604</b>	24'	10	\$199	\$216	\$216	\$259	\$287
 <p><b>Interlocking Stop</b> (Snap fits with CS118 interlocking stop)</p>	<b>CS118</b>	24'	10	\$55	\$61	\$61	\$118	\$140
 <p><b>Head Expander</b> (Snap fits with CS119 Head Expander - Requires VG10 Gasket)</p>	<b>CS619</b>	24'	6	\$237	\$255	\$255	\$274	\$297

Note: Add Finish Code to the Part Number when ordering (Ex: **CS604T-11** for Clear Anodized Finish)







DOOR FRAME EXTRUSIONS								
PART DESCRIPTION	PART NO.	PART LENGTH	PCS. PER BOX	FINISH CODE/STOCK LENGTH LIST PRICE				
				#11 CLEAR	#21 BRONZE	#81 WHITE	#2604 POWDER	#2605 POWDER
 <p><b>Door Header for Offset Doors</b> (Requires DS200 Door Stop)</p>	<b>FL607</b>	24'	3	\$555	\$576	\$576	\$742	\$810
 <p><b>Door Jamb for Offset Doors</b> (Requires DS200 Door Stop)</p>	<b>FL609</b>	24'	4	\$362	\$388	\$388	\$487	\$539
 <p><b>Door Header for COC Offset Doors</b> (Requires DS202 Door Stop) (Note: 2"x6" Doorframe Header Profile )</p>	<b>FL612</b>	24'	4	\$432	\$446	\$446	\$661	\$730
 <p><b>Heavy Wall Door Jamb</b></p>	<b>FL649</b>	24'	3	\$465	\$492	\$492	\$534	\$579
 <p><b>Snap-In Door Stop</b> (Requires WP200 Weathering)</p>	<b>DS200</b>	16'	20	\$44	\$48	\$48	\$89	\$110
 <p><b>Transom Sash for 1" Glass</b> (Requires FL518 Glass Stop)</p>	<b>CS115</b>	24'	12	\$80	\$87	\$87	\$135	\$157
 <p><b>Glass Stop for Transom Sash</b></p>	<b>FL518</b>	24'	12	\$49	\$54	\$54	\$114	\$138
 <p><b>Door Stop</b> (Use with FL612) (Use WP200 Pile)</p>	<b>DS202</b>	24'	5	\$110	\$118	\$118	\$190	\$224
 <p><b>Door Stop Thermal Door</b></p>	<b>DS600</b>	16'	10	\$41	\$45	\$45	\$79	\$96

Note: Add Finish Code to the Part Number when ordering (Ex: **FL612T-11** for Clear Anodized Finish)









# FL600·2¼" x 6"



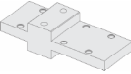



## Screw-Spline Storefront

### OPTIONAL DOOR EXTRUSIONS

PART DESCRIPTION	PART NO.	PART LENGTH	PCS. PER BOX	FINISH CODE/STOCK LENGTH LIST PRICE					
				#11 CLEAR	#21 BRONZE	#81 WHITE	#2604 POWDER	#2605 POWDER	
 Door Rail Shoe Base	DB124	24'-3"	8	Mill-00	N/A	N/A	N/A	N/A	
				\$38					
 ¼" Door Rail Base Extension	DB123	24'-3"	8	\$96	\$103	\$103	\$154	\$177	
 Mid Rail Adapter	D113	19'-9"	10	Mill-00	N/A	N/A	N/A	N/A	
				\$49					
	4" Muntin or Sidelite Base	D102	16'	4	\$195	\$205	\$205	\$263	\$293
	7-½" Muntin or Sidelite Base	D108	16'	4	\$313	\$327	\$327	\$439	\$486
	9-½" Muntin or Sidelite Base	D109	16'	4	\$380	\$395	\$395	\$537	\$597
 Door Glass Stop for ¼" Glazing (Use NG4 Gasket)	DG100	16'	20	\$33	\$41	\$41	\$67	\$80	
 Door Glass Stop for 1" Glazing (Use NG41S Gasket)	DG101	16'	18	\$28	\$38	\$38	\$61	\$73	

Note: Add Finish Code to the Part Number when ordering (Ex: **FL321T-11** for Clear Anodized Finish)

ACCESSORIES			
PART DESCRIPTION	PART NO.	QTY	PRICE PER BOX
 <b>Spline Screw</b> #14 x 1 HHSTS (Assembly Screw)	AS16	100 (AS16-1)	\$17
 <b>#6 x 3/8" PPH</b> <b>Type AB</b> (Attaches End Dams)	AS31	100 (AS21-1)	\$8
 <b>#10-24 x 3/8"</b> <b>UCPFH</b> (Attaching SR101 or SR102 Steel Reinforcing)	AS24	100 (AS24-1)	\$27
 <b>Drill Jig for</b> <b>Screw Spline</b> (Required for Series FL600 Storefront)	DJ600	1	\$426
 <b>End Dam for</b> <b>Sill Flashing</b> (Requires Two AS21 Screws)	ED639-1	20 (ED639-2)	\$42
 <b>EPDM Gasket</b> (Standard Gasket for 1/4" Glazing)	NG1	300 FT. (Per Roll)	\$163
 <b>Heavy Glazing</b> <b>Gasket</b>	NG2	500 FT. (Per Roll)	\$410
 <b>3/8" Glazing</b> <b>Gasket</b>	NG3	250 FT. (Per Roll)	\$158
 <b>Caulking Stop</b> (Used at FL634 Head and Jambs)	CS604P-1	10	\$658

ACCESSORIES			
PART DESCRIPTION	PART NO.	QTY	PRICE PER BOX
 <b>4" Long EPDM</b> <b>Setting Block</b> for 1" Glass (Exterior Glazing - Two Per Lite)	SB3	100 (SB3-1)	\$116
 <b>Water Diverter</b> (Horizontal - Two Per Lite)	WD300-1	50 (WD300-2)	\$74
 <b>Vinyl Gasket</b> (Standard Weathering Gasket for FL210 and CS118 / CS119)	VG10	250 FT. (VG10-1) (Per Roll)	\$221
 <b>Joint Sealant</b> <b>Tape</b> (1/8" x 1/2" for Sealing Horizontal to Vertical Member Connections)	SM5601	30 FT. (Per Roll)	\$44
 <b>Weathering</b> for D200	WP200	500 FT. (Per Roll)	\$116
 <b>Steel Bracket for</b> <b>Muntin Assembly</b> to Door Stile	TH401	50 (TH401-2)	\$112
 <b>#8 x 3/4" POH</b> <b>TEK Screw</b>	AS7	100 (AS7-1)	\$33

Page Left Intentionally Blank









Section B8  
Table of Contents

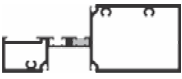

2¼" x 6"

	<i>Page</i>
Standard Framing Extrusions.....	1
Optional Framing Extrusions .....	2
Door Framing Extrusions .....	3
Optional Door Extrusions .....	4
Accessories .....	5

Page Left Intentionally Blank



STANDARD FRAMING EXTRUSIONS									
PART DESCRIPTION	PART NO.	PART LENGTH	PCS. PER BOX	FINISH CODE/STOCK LENGTH LIST PRICE					
				#11 CLEAR	#21 BRONZE	#81 WHITE	#2604 POWDER	#2605 POWDER	
 <b>Head / Vertical / Jamb</b>	<b>FL634T</b>	24'	4	\$455	\$492	\$492	\$590	\$639	
 <b>Sill / Intermediate Horizontal</b>	<b>FL626T</b>	24'	3	\$525	\$541	\$541	\$702	\$752	
 <b>Glass Stop</b>	<b>FL303</b>	24'	10	\$65	\$72	\$72	\$123	\$145	
 <b>Shallow Pocket Filler</b>	<b>FL625T</b>	24'	10	\$250	\$265	\$265	\$313	\$339	
 <b>Expansion Mullion</b> (Requires VG10 Gasket)	<b>FL610T</b>	24'	4	\$376	\$399	\$399	\$492	\$535	
 <b>Expansion Female Mullion</b> (Mates w/FL610 Expansion Mullion)	<b>FL611T</b>	24'	4	\$416	\$443	\$443	\$553	\$602	
 <b>Sub-Sill Flashing</b>	<b>FL639T</b>	24'	10	\$350	\$374	\$374	\$450	\$481	

Note: Add Finish Code to the Part Number when ordering (Ex: **FL610T-11** for Clear Anodized Finish)







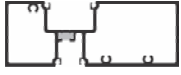

# FL600T·2¼" x 6"

## Thermal Screw-Spline Storefront

### OPTIONAL FRAMING EXTRUSIONS

PART DESCRIPTION	PART NO.	PART LENGTH	PCS. PER BOX	FINISH CODE/STOCK LENGTH LIST PRICE				
				#11 CLEAR	#21 BRONZE	#81 WHITE	#2604 POWDER	#2605 POWDER
 <p><b>Flat Filler</b> Snap fits with Open Back Wall Jamb/Head Members)</p>	<b>CS604T</b>	24'	10	\$237	\$254	\$254	\$294	\$324
 <p><b>Interlocking Stop</b> (Snap fits with CS118 interlocking stop)</p>	<b>CS118</b>	24'	10	\$55	\$61	\$61	\$118	\$140
 <p><b>Head Expander</b> (Snap fits with CS119 Head Expander - Requires VG10 Gasket)</p>	<b>CS619T</b>	24'	6	\$279	\$300	\$300	\$330	\$360

Note: Add Finish Code to the Part Number when ordering (Ex: **CS604T-11** for Clear Anodized Finish)







DOOR FRAME EXTRUSIONS								
PART DESCRIPTION	PART NO.	PART LENGTH	PCS. PER BOX	FINISH CODE/STOCK LENGTH LIST PRICE				
				#11 CLEAR	#21 BRONZE	#81 WHITE	#2604 POWDER	#2605 POWDER
 <b>Door Header for Offset Doors</b> (Requires DS200 Door Stop)	<b>FL607T</b>	24'	3	\$593	\$614	\$614	\$840	\$906
 <b>Door Jamb for Offset Doors</b> (Requires DS200 Door Stop)	<b>FL609T</b>	24'	4	\$399	\$426	\$426	\$565	\$616
 <b>Door Header for COC Offset Doors</b> (Requires DS202 Door Stop) (Note: 2"x6" Doorframe Header Profile )	<b>FL612</b>	24'	4	\$432	\$446	\$446	\$661	\$730
 <b>Heavy Wall Door Jamb</b>	<b>FL649T</b>	24'	3	\$518	\$540	\$540	\$580	\$610
 <b>Snap-In Door Stop</b> (Requires WP200 Weathering)	<b>DS200</b>	16'	20	\$44	\$48	\$48	\$89	\$110
 <b>Transom Sash for 1" Glass</b> (Requires FL518 Glass Stop)	<b>CS115</b>	24'	12	\$80	\$87	\$87	\$135	\$157
 <b>Glass Stop for Transom Sash</b>	<b>FL518</b>	24'	12	\$49	\$54	\$54	\$114	\$138
 <b>Door Stop</b> (Use with FL612) (Use WP200 Pile)	<b>DS202</b>	24'	5	\$110	\$118	\$118	\$190	\$224
 <b>Door Stop Thermal Door</b>	<b>DS600</b>	16'	10	\$41	\$45	\$45	\$79	\$96

Note: Add Finish Code to the Part Number when ordering (Ex: **FL612T-11** for Clear Anodized Finish)







# FL600T·2¼" x 6"





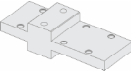

## Thermal Screw-Spline Storefront



OPTIONAL DOOR EXTRUSIONS									
PART DESCRIPTION	PART NO.	PART LENGTH	PCS. PER BOX	FINISH CODE/STOCK LENGTH LIST PRICE					
				#11 CLEAR	#21 BRONZE	#81 WHITE	#2604 POWDER	#2605 POWDER	
 Door Rail Shoe Base	DB124	24'-3"	8	Mill-00	N/A	N/A	N/A	N/A	
				\$38					
 ¼" Door Rail Base Extension	DB123	24'-3"	8	\$96	\$103	\$103	\$154	\$177	
 Mid Rail Adapter	D113	19'-9"	10	Mill-00	N/A	N/A	N/A	N/A	
				\$49					
	4" Muntin or Sidelite Base	D102	16'	4	\$195	\$205	\$205	\$263	\$293
	7-½" Muntin or Sidelite Base	D108	16'	4	\$313	\$327	\$327	\$439	\$486
	9-½" Muntin or Sidelite Base	D109	16'	4	\$380	\$395	\$395	\$537	\$597
 Door Glass Stop for ¼" Glazing (Use NG4 Gasket)	DG100	16'	20	\$33	\$41	\$41	\$67	\$80	
 Door Glass Stop for 1" Glazing (Use NG41S Gasket)	DG101	16'	18	\$28	\$38	\$38	\$61	\$73	

Note: Add Finish Code to the Part Number when ordering (Ex: **FL321T-11** for Clear Anodized Finish)

ACCESSORIES			
PART DESCRIPTION	PART NO.	QTY	PRICE PER BOX
 <b>Spline Screw</b> #14 x 1 HHSTS (Assembly Screw)	AS16	100 (AS16-1)	\$17
 <b>#6 x 3/8" PPH</b> <b>Type AB</b> (Attaches End Dams)	AS31	100 (AS21-1)	\$8
 <b>#10-24 x 3/8"</b> <b>UCPFH</b> (Attaching SR101 or SR102 Steel Reinforcing)	AS24	100 (AS24-1)	\$27
 <b>Drill Jig for</b> <b>Screw Spline</b> (Required for Series FL600 Storefront)	DJ600	1	\$426
 <b>End Dam for</b> <b>Sill Flashing</b> (Requires Two AS21 Screws)	ED639-1	20 (ED639-2)	\$42
 <b>EPDM Gasket</b> (Standard Gasket for 1/4" Glazing)	NG1	300 FT. (Per Roll)	\$153
 <b>Heavy Glazing</b> <b>Gasket</b>	NG2	500 FT. (Per Roll)	\$410
 <b>3/8" Glazing</b> <b>Gasket</b>	NG3	250 FT. (Per Roll)	\$158

ACCESSORIES			
PART DESCRIPTION	PART NO.	QTY	PRICE PER BOX
 <b>4" Long EPDM</b> <b>Setting Block</b> for 1" Glass (Exterior Glazing - Two Per Lite)	SB3	100 (SB3-1)	\$116
 <b>Water Diverter</b> (Horizontal - Two Per Lite)	WD300-1	50 (WD300-2)	\$74
 <b>Vinyl Gasket</b> (Standard Weathering Gasket for FL210 and CS118 / CS119)	VG10	250 FT. (VG10-1) (Per Roll)	\$221
 <b>Joint Sealant</b> <b>Tape</b> (1/8" x 1/2" for Sealing Horizontal to Vertical Member Connections)	SM5601	30 FT. (Per Roll)	\$44
 <b>Weathering</b> for D200	WP200	500 FT. (Per Roll)	\$116
 <b>Steel Bracket for</b> <b>Muntin Assembly</b> to Door Stile	TH401	50 (TH401-2)	\$112
 <b>#8 x 3/4" POH</b> <b>TEK Screw</b>	AS7	100 (AS7-1)	\$33

Page Left Intentionally Blank









Section B9  
Table of Contents

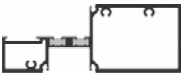

2¼" x 6"

	<i>Page</i>
Standard Framing Extrusions.....	1
Optional Framing Extrusions .....	2
Door Framing Extrusions .....	3
Optional Door Extrusions .....	4
Accessories .....	5

Page Left Intentionally Blank



STANDARD FRAMING EXTRUSIONS									
PART DESCRIPTION	PART NO.	PART LENGTH	PCS. PER BOX	FINISH CODE/STOCK LENGTH LIST PRICE					
				#11 CLEAR	#21 BRONZE	#81 WHITE	#2604 POWDER	#2605 POWDER	
 <b>Head / Vertical / Jamb</b>	<b>FL634U</b>	24'	4	\$493	\$525	\$525	\$606	\$640	
 <b>Sill / Intermediate Horizontal</b>	<b>FL626U</b>	24'	3	\$553	\$573	\$573	\$782	\$850	
 <b>Glass Stop</b>	<b>FL303</b>	24'	10	\$65	\$72	\$72	\$123	\$145	
 <b>Shallow Pocket Filler</b>	<b>FL625U</b>	24'	10	\$282	\$300	\$300	\$373	\$407	
 <b>Expansion Mullion</b> (Requires VG10 Gasket)	<b>FL610U</b>	24'	4	\$406	\$433	\$433	\$499	\$530	
 <b>Expansion Female Mullion</b> (Mates w/FL610 Expansion Mullion)	<b>FL611U</b>	24'	4	\$447	\$476	\$476	\$560	\$611	
 <b>Sub-Sill Flashing</b>	<b>FL639U</b>	24'	10	\$343	\$370	\$370	\$513	\$560	

Note: Add Finish Code to the Part Number when ordering (Ex: **FL610U-11** for Clear Anodized Finish)







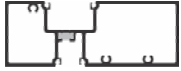

# FL600UT·2¼" x 6"

## Thermal Screw-Spline Storefront

### OPTIONAL FRAMING EXTRUSIONS

PART DESCRIPTION	PART NO.	PART LENGTH	PCS. PER BOX	FINISH CODE/STOCK LENGTH LIST PRICE				
				#11 CLEAR	#21 BRONZE	#81 WHITE	#2604 POWDER	#2605 POWDER
 <p><b>Flat Filler</b> Snap fits with Open Back Wall Jamb/Head Members)</p>	<b>CS604U</b>	24'	10	\$275	\$292	\$292	\$322	\$345
 <p><b>Interlocking Stop</b> (Snap fits with CS118 interlocking stop)</p>	<b>CS118</b>	24'	10	\$55	\$61	\$61	\$118	\$140
 <p><b>Head Expander</b> (Snap fits with CS119 Head Expander - Requires VG10 Gasket)</p>	<b>CS619U</b>	24'	6	\$313	\$331	\$331	\$359	\$383s

Note: Add Finish Code to the Part Number when ordering (Ex: **CS604U-11** for Clear Anodized Finish)







DOOR FRAME EXTRUSIONS								
PART DESCRIPTION	PART NO.	PART LENGTH	PCS. PER BOX	FINISH CODE/STOCK LENGTH LIST PRICE				
				#11 CLEAR	#21 BRONZE	#81 WHITE	#2604 POWDER	#2605 POWDER
 <b>Door Header for Offset Doors</b> (Requires DS200 Door Stop)	<b>FL607T</b>	24'	3	\$593	\$614	\$614	\$840	\$906
 <b>Door Jamb for Offset Doors</b> (Requires DS200 Door Stop)	<b>FL609T</b>	24'	4	\$399	\$426	\$426	\$565	\$616
 <b>Door Header for COC Offset Doors</b> (Requires DS202 Door Stop) (Note: 2"×6" Doorframe Header Profile )	<b>FL612</b>	24'	4	\$432	\$446	\$446	\$661	\$730
 <b>Heavy Wall Door Jamb</b>	<b>FL649T</b>	24'	3	\$518	\$540	\$540	\$580	\$610
 <b>Snap-In Door Stop</b> (Requires WP200 Weathering)	<b>DS200</b>	16'	20	\$44	\$48	\$48	\$89	\$110
 <b>Transom Sash for 1" Glass</b> (Requires FL518 Glass Stop)	<b>CS115</b>	24'	12	\$80	\$87	\$87	\$135	\$157
 <b>Glass Stop for Transom Sash</b>	<b>FL518</b>	24'	12	\$49	\$54	\$54	\$114	\$138
 <b>Door Stop</b> (Use with FL612) (Use WP200 Pile)	<b>DS202</b>	24'	5	\$110	\$118	\$118	\$190	\$224
 <b>Door Stop Thermal Door</b>	<b>DS600</b>	16'	10	\$41	\$45	\$45	\$79	\$56

Note: Add Finish Code to the Part Number when ordering (Ex: **FL612-11** for Clear Anodized Finish)







# FL600UT·2¼" x 6"





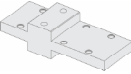

## Thermal Screw-Spline Storefront

### OPTIONAL DOOR EXTRUSIONS

PART DESCRIPTION	PART NO.	PART LENGTH	PCS. PER BOX	FINISH CODE/STOCK LENGTH LIST PRICE					
				#11 CLEAR	#21 BRONZE	#81 WHITE	#2604 POWDER	#2605 POWDER	
 Door Rail Shoe Base	DB124	24'-3"	8	Mill-00	N/A	N/A	N/A	N/A	
				\$38					
 ¼" Door Rail Base Extension	DB123	24'-3"	8	\$96	\$103	\$103	\$154	\$177	
 Mid Rail Adapter	D113	19'-9"	10	Mill-00	N/A	N/A	N/A	N/A	
				\$49					
	4" Muntin or Sidelite Base	D102	16'	4	\$195	\$205	\$205	\$263	\$293
	7-½" Muntin or Sidelite Base	D108	16'	4	\$313	\$327	\$327	\$439	\$486
	9-½" Muntin or Sidelite Base	D109	16'	4	\$380	\$395	\$395	\$537	\$597
 Door Glass Stop for ¼" Glazing (Use NG4 Gasket)	DG100	16'	20	\$33	\$41	\$41	\$67	\$80	
 Door Glass Stop for 1" Glazing (Use NG41S Gasket)	DG101	16'	18	\$28	\$38	\$38	\$61	\$73	

Note: Add Finish Code to the Part Number when ordering (Ex: **FL321T-11** for Clear Anodized Finish)

ACCESSORIES			
PART DESCRIPTION	PART NO.	QTY	PRICE PER BOX
 <b>Spline Screw #14 x 1 HHSTS</b> (Assembly Screw)	AS16	100 (AS16-1)	\$17
 <b>#6 x ¾" PPH Type AB</b> (Attaches End Dams)	AS31	100 (AS21-1)	\$8
 <b>#10-24 x ¾" UCPFH</b> (Attaching SR101 or SR102 Steel Reinforcing)	AS24	100 (AS24-1)	\$27
 <b>Drill Jig for Screw Spline</b> (Required for Series FL600 Storefront)	DJ600	1	\$426
 <b>End Dam for Sill Flashing</b> (Requires Two AS21 Screws)	ED639-1	20 (ED639-2)	\$42
 <b>EPDM Gasket</b> (Standard Gasket for ¼" Glazing)	NG1	300 FT. (Per Roll)	\$163
 <b>Heavy Glazing Gasket</b>	NG2	500 FT. (Per Roll)	\$410
 <b>¾" Glazing Gasket</b>	NG3	250 FT. (Per Roll)	\$158

ACCESSORIES			
PART DESCRIPTION	PART NO.	QTY	PRICE PER BOX
 <b>4" Long EPDM Setting Block for 1" Glass</b> (Exterior Glazing - Two Per Lite)	SB3	100 (SB3-1)	\$116
 <b>Water Diverter</b> (Horizontal - Two Per Lite)	WD300-1	50 (WD300-2)	\$74
 <b>Vinyl Gasket</b> (Standard Weathering Gasket for FL210 and CS118 / CS119)	VG10	250 FT. (VG10-1) (Per Roll)	\$221
 <b>Joint Sealant Tape</b> (½" x ½" for Sealing Horizontal to Vertical Member Connections)	SM5601	30 FT. (Per Roll)	\$44
 <b>Weathering for D200</b>	WP200	500 FT. (Per Roll)	\$116
 <b>Steel Bracket for Muntin Assembly to Door Stile</b>	TH401	50 (TH401-2)	\$112
 <b>#8 x ¾" POH TEK Screw</b>	AS7	100 (AS7-1)	\$33

Page Left Intentionally Blank



**Section C**  
**CURTAIN WALLS**  
**Table of Contents**

PW251 Curtain Wall System..... C1

Page Left Intentionally Blank







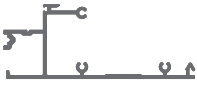
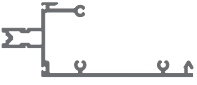

Section C1  
Table of Contents

**PW251**  
PANELIZED CURTAIN WALL

2½" x 7"

	<i>Page</i>
Standard Framing Extrusions.....	1
Corner Framing Extrusions .....	2
Optional Framing Extrusions .....	3
Door Framing Extrusions .....	3
Accessories.....	4
Steel Reinforcing.....	5
Glazing Infill Charts and Setting Block/Setting Chair Charts .....	5

Page Left Intentionally Blank







STANDARD FRAMING EXTRUSIONS									
PART DESCRIPTION	PART NO.	PART LENGTH	PCS. PER BOX	FINISH CODE/STOCK LENGTH LIST PRICE					
				#11 CLEAR	#21 BRONZE	#81 WHITE	#2604 POWDER	#2605 POWDER	
 <b>Head/Sill</b>	PW152	24'	3	Mill-00 \$269	N/A	N/A	N/A	N/A	
 <b>Intermediate Horizontal</b>	PW155	24'	3	\$357	\$380	\$380	\$403	\$427	
 <b>Head/Horizontal/Sill Trim</b>	PW203	24'	4	\$187	\$202	\$202	\$249	\$287	
 <b>Wall Jamb</b>	PW153	24'	3	\$371	\$398	\$398	\$404	\$444	
 <b>Vertical Mullion</b>	PW150	24'	3	\$373	\$397	\$397	\$414	\$454	
 <b>Vertical Mullion Butt Glazed</b>	PW151	24'	3	\$307	\$328	\$328	\$359	\$399	
 <b>Vertical Mullion Filler</b>	PW202	24'	12	\$128	\$138	\$138	\$173	\$201	
 <b>Pocket Filler for PW150</b> (For use at Jamb)	PW213	24'	8	\$49	\$55	\$55	\$98	\$119	
 <b>Pre-Punched Pressure Bar w/ Spacer Gasket</b>	PW204-1	24'	12	Mill-00 \$108	N/A	N/A	N/A	N/A	
 <b>Vertical/Horizontal Face Cover</b>	PW205	24'	12	\$59	\$66	\$66	\$109	\$129	

Note: Add Finish Code to the Part Number when ordering (Ex: PW150-11 for Clear Anodized Finish)





# PW251·2½" x 7"



## Screw-Spline Curtain Wall



CORNER FRAMING EXTRUSIONS								
PART DESCRIPTION	PART NO.	PART LENGTH	PCS. PER BOX	FINISH CODE/STOCK LENGTH LIST PRICE				
				#11 CLEAR	#21 BRONZE	#81 WHITE	#2604 POWDER	#2605 POWDER
 <b>90° Outside Corner</b>	PW156	24'	4	Mill-00	N/A	N/A	N/A	N/A
				\$164				
 <b>90° Outside Corner Pre-punched Pressure Bar with Spacer Gasket</b>	PW157-1	24'	4	Mill-00	N/A	N/A	N/A	N/A
				\$231				
 <b>Glazing Face Cover 90° Outside Corner</b> (2 required)	PW158	24'	12	\$84	\$93	\$93	\$150	\$175
 <b>Female Half 90° Outside Corner</b>	PW208	24'	4	\$234	\$251	\$251	\$296	\$331
 <b>Male Half 90° Outside Corner</b>	PW209	24'	4	\$248	\$265	\$265	\$305	\$341
 <b>Interior 90° Corner Trim</b>	PW210	24'	4	\$124	\$133	\$133	\$194	\$226
 <b>90° Corner Splice</b>	PW211	24'	4	Mill-00	N/A	N/A	N/A	N/A
				\$166				

Note: Add Finish Code to the Part Number when ordering (Ex: **PW150-11** for Clear Anodized Finish)

DOOR FRAMING EXTRUSIONS								
PART DESCRIPTION	PART NO.	PART LENGTH	PCS. PER BOX	FINISH CODE/STOCK LENGTH LIST PRICE				
				#11 CLEAR	#21 BRONZE	#81 WHITE	#2604 POWDER	#2605 POWDER
 Header / Transom Bar for Surface Mount Closer	FL207	24'	4	\$318	\$334	\$334	\$455	\$509
 Frame Jamb	PW214	24'	4	\$192	\$209	\$209	\$256	\$292
 COC Transom Bar / Header	FL212	24'	4	\$248	\$258	\$258	\$429	\$489
 Snap-in Door Stop (Use with FL207)	DS200	24'	3	\$44	\$48	\$48	\$89	\$110
 Screw Applied Door Stop (Use with FL212)	DS202	24'	4	\$110	\$118	\$118	\$190	\$224







OPTIONAL FRAMING EXTRUSIONS								
PART DESCRIPTION	PART NO.	PART LENGTH	PCS. PER BOX	FINISH CODE/STOCK LENGTH LIST PRICE				
				#11 CLEAR	#21 BRONZE	#81 WHITE	#2604 POWDER	#2605 POWDER
 ¼" Glazing Adapter	PW212	24'	4	\$38	\$44	\$44	\$98	\$119
 ¼" Transition Glazing Adapter for Butt - Glazed Mullion	PW215	24'	4	Mill-00	N/A	N/A	N/A	N/A
				\$77				
 Splice Sleeve / or Mullion Reinforcement	PW207	24'	3	\$265	N/A	N/A	N/A	N/A

Note: Add Finish Code to the Part Number when ordering (Ex: **PW150-11** for Clear Anodized Finish)

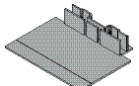
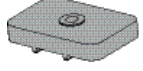

# PW251·2½" x 7"

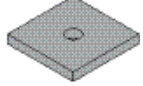
## Screw-Spline Curtain Wall

ACCESSORIES			
PART DESCRIPTION	PART NO.	QUANTITY	PRICE PER BOX
 <b>Spline Screw #14 x 1 HHSTS</b>	AS16	100 (AS16-1)	\$17
 <b>#6 x 3/8" PPH Type AB</b> (Attaches End Dams)	AS31	100 (AS21-1)	\$8
 <b>#12 x 3/4" HWH #3 Zinc Plated Self Drilling</b>	AS25	100 (AS25-1)	\$12
 <b>12 x 1 1/4" HWH #3 Zinc Plated Self Drilling</b> (Pressure Bar Screws)	AS32	200 (AS32-1)	\$26
 <b>12 x 1" FHP Self Drilling</b>	AS35	100 (AS35-1)	\$20
 <b>3 x 1/4 x 20 Hex Head Bolt SS</b>	AS53	25 (AS53-1)	\$30
 <b>1/4 Flat Washer SS</b>	AS54	50 (AS54-1)	\$12
 <b>1/4 x 20 Lock Nut SS</b>	AS55	25 (AS55-1)	\$13
 <b>Interior / Exterior Glazing Gasket at Glass</b>	NG10	250 FT. (Per Roll)	\$155
 <b>Exterior Perimeter Gasket</b>	NG11	500 FT. (Per Roll)	\$313
 <b>Butt Glaze Spacer Gasket</b>	NG14	500 FT. (Per Roll)	\$245

ACCESSORIES			
PART DESCRIPTION	PART NO.	QUANTITY	PRICE PER BOX
 <b>4" Long EPDM Setting Block for 1" Glass</b>	SB251	100 (SB251-1)	\$107
 <b>End Dam</b>	SP203	50 (SP203-1)	\$30
 <b>Butt Glaze Mullion Bridge for 1" Glazing</b>	SP207	50 (SP207-1)	\$32
 <b>Top and Bottom Mullion Cover</b>	SP209	50 (SP209-1)	\$179
 <b>Temporary Glazing Retainer</b>	SP253	50 (SP253-1)	\$62
 <b>Joint Sealant Tape</b> (1/4" x 1/2" for Sealing Horizontal to Vertical Member Connections)	SM5601	30 FT. (Per Roll)	\$44
 <b>1.475 x 1.475 x .180 Zinc Plated Steel Square Nut</b>	AS13	50	\$62
 <b>Weather Stripping</b>	WP200	500 FT. (Per Roll)	\$116



STEEL REINFORCING			
PART DESCRIPTION	PART NO.	QUANTITY LENGTH	PRICE
 <p><b>1⅞" x 4½" x ¼"</b>            with Zinc Chromate            Primer Steel Reinforcing</p>	SR150	1	\$461
		12'-0"	
 <p><b>1⅞" x 4½" x 10 Ga.</b>            Steel Reinforcing</p>	SR151	1	\$415
		14'-0"	
 <p><b>1⅞" x 4⅝" x ¼"</b>            with Zinc Chromate            Primer Steel Reinforcing</p>	SR504	1	\$409
		10'-0"	

Page Left Intentionally Blank

**Section D**  
**IMPACT-RESISTANT ENTRANCES**  
**Table of Contents**

Impact-Resistant Entrances..... D1  
Adds, Substitutions, and Modifications..... D2

Page Left Intentionally Blank

Section D1  
Table of Contents

**IMPACT-RESISTANT ENTRANCES**

**Doors and Frames**

Entrance Door Handing Information.....	1
Door Types and Descriptions.....	3
Entrance Door and Numbering Information.....	5
Push/Pull Hardware Options.....	7
Glass Sizes.....	9
Standard Hardware Locations.....	11
Notes and Policies.....	13
Options & Limitation Charts.....	15-19
Impact-Resistant Butt Hung Door and Frames .....	20-23
Impact-Resistant Butt Hung CVR Panic Doors and Frames .....	24-27
Impact-Resistant Butt Hung Offset Arm Assembly Doors and Frames .....	28-31
Impact-Resistant Butt Hung CVR Panic Offset Arm Assembly Doors and Frames .....	32-35

Page Left Intentionally Blank

Commercial aluminum storefront and entrance doors are primarily designed for:

1. Exterior applications
2. To swing or open out
3. In the case of double acting doors, to swing in and out

Because of the design, and due to building codes and life safety laws prohibiting such, single acting doors may never swing inward when installed in an exterior application. However, when used for interior applications (Example: Interior office doors), unless prevented by a particular building code, doors may swing in, or open to the interior.

**HAND:** All single acting swing doors are handed. The hand of a single acting swing door indicates which side it is hinged on (or will swing from) and the direction in which it is to swing. When determining the hand of a door, it should be viewed from the exterior. It will either be hinged on its left side, or hinged on its right side, and (for exterior applications) will always swing out. For interior applications, it may swing in.

The “hand” of a door is designated as follows.

For **Exterior applications** (as viewed from the exterior):

1. HL SO Hinge Left Swing Out = RH (Right Hand Door)
2. HR SO Hinge Right Swing Out = LH (Left Hand Door)

For **Interior applications** (as viewed from the exterior):

1. HL SO Hinge Left Swing Out = RH (Right Hand Door)
2. HR SI Hinge Right Swing In = RH (Right Hand Door)
3. HR SO Hinge Right Swing Out = LH (Left Hand Door)
4. HL SI Hinge Left Swing In = LH (Left Hand Door)

**SINGLE ACTING** commercial aluminum entrances are designed for exterior applications and to open or “swing” in an outward direction. To determine the “hand” of a single acting entrance, envision placing your back against the hinge side of the opening and extend whichever hand would be appropriate for the direction the door opens.

Only entrances used in interior applications are allowed to swing in an inward direction. The same method described above for determining the “hand” of the door applies

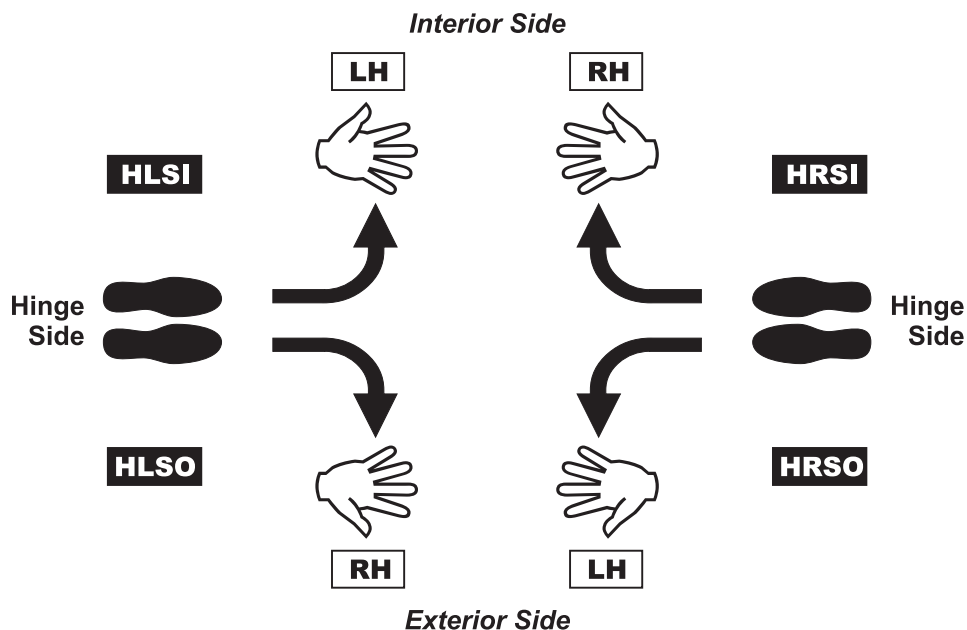

Page Left Intentionally Blank



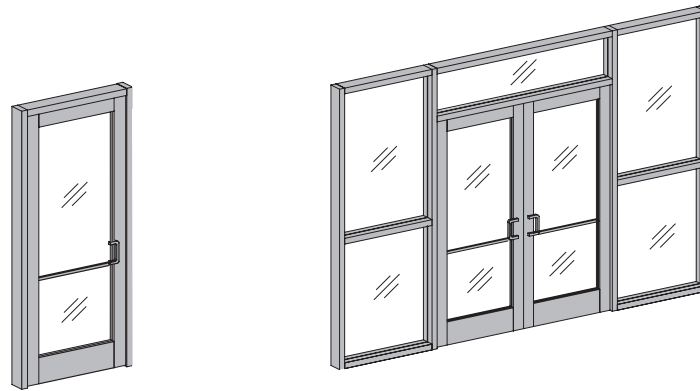

Aluminum Entrance Doors	VERTICAL STILE	TOP RAIL	BOTTOM RAIL	RECOMMENDED LIMITATIONS	TRAFFIC APPLICATION
Series 281 Narrow Stile	2 1/8"	2 1/4"	7 1/2"	3'-0" x 7'-0"	Normal
Series 381 Medium Stile	3 3/4"	4"	7 1/2"	3'-6" x 8'-0"	Moderate
Series 581 Wide Stile	5"	4"	7 1/2"	3'-6" x 8'-0"	Heavy

Note: All Impact doors require 1-1/2 pair butt hinges.

Note: Impact Doors with 1" insulated glazing and a door height > 84", require 2 pair of Butt Hinges.

### COMMON DOOR AND FRAME DESCRIPTIONS

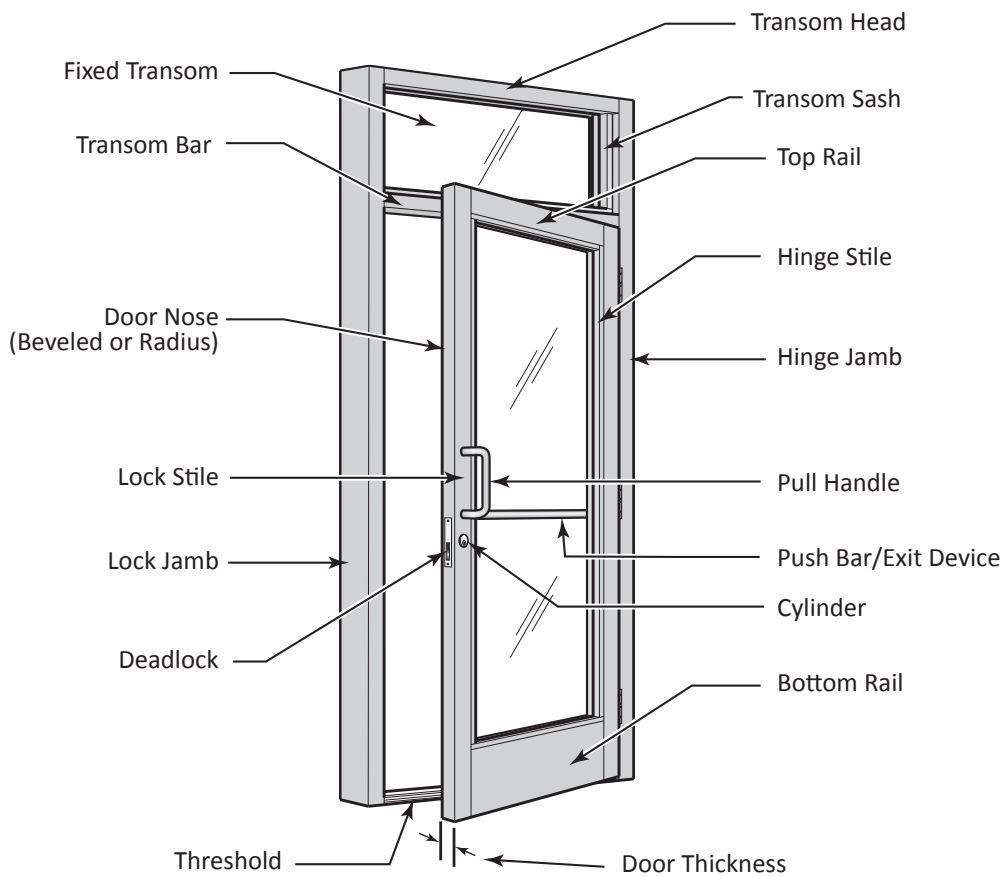

Page Left Intentionally Blank

**DOOR  
PART NUMBER  
INFORMATION**

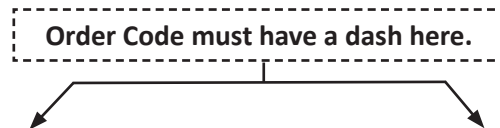

D.O.W. (Inches)	D.O.H. (Inches)	STILE WIDTH	SWING & HINGING	ADDED HARDWARE	FINISH CODE
36 <i>(Specify)</i>	84 <i>(Specify)</i>	<i>(Select)</i>	A <i>(Select)</i>	P <i>(Select)</i>	11 <i>(Select)</i>
DOOR OPENING WIDTH	DOOR OPENING HEIGHT	NARROW = HN MEDIUM = HR WIDE = HS	FROM CHART 1	P = CVR PANIC O = OFFSET ARM	#11 CLEAR #21 BRONZE # 81 White PC #99 2604 PC #89 2605 PC

**For example: (3684HR-AP-11)**

*The above example depicts a 3684 Right Hand Butt Hinge Medium Door with CVR Panic in Clear Anodized Finish*

**FRAME  
PART NUMBER  
INFORMATION**

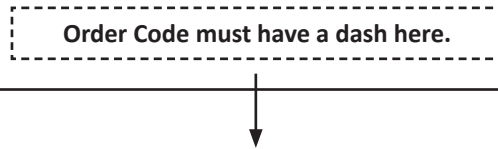

D.O.W. (INCHES)	D.O.H. (Inches)	SWING & HINGING	ADDED HARDWARE	FRAME TYPE	FINISH CODE
36 <i>(Specify)</i>	84 <i>(Specify)</i>	A <i>(Select)</i>	P <i>(Select)</i>	F5 <i>(Select)</i>	11 <i>(Select)</i>
DOOR OPENING WIDTH	DOOR OPENING HEIGHT	FROM CHART 1	P= PANIC O= OFFSET ARM	F5= FRAME FT5= FRAME W/TRANSOM	#11 CLEAR #21 BRONZE # 81 White PC #99 2604 PC #89 2605 PC

**For example: (3684-A-F5-11)**

*The above example depicts a 3684 Right Hand Butt Hinge Frame in Clear Anodized Finish*

**F5** = 2 ½" x 5" Frame

**FT5** = 2 ½" x 5" Frame w/ Transom

**CHART 1**

	BUTT HUNG
RIGHT HAND SINGLE	A
LEFT HAND SINGLE	B
PAIR OF DOORS	J

Page Left Intentionally Blank

**Traditional Hardware**  
Standard on all Doors

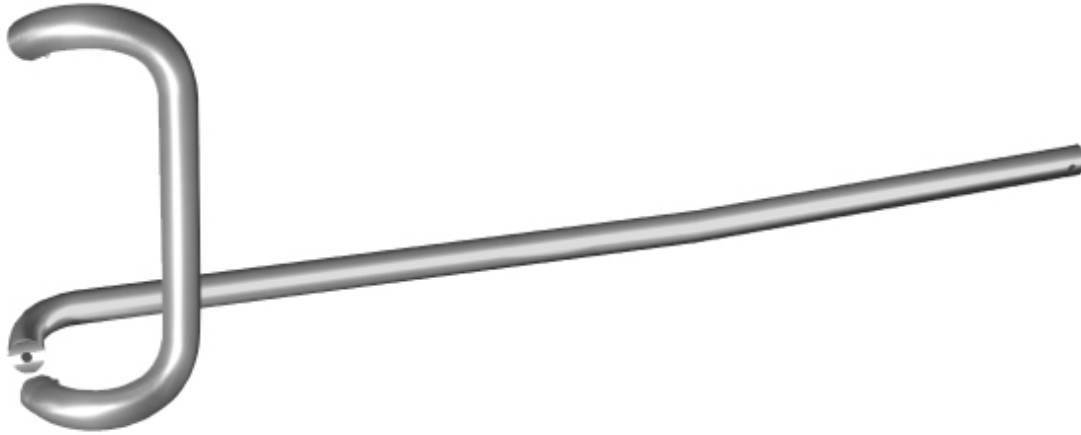

Clear Push/Pull is standard on clear and powder coat doors.  
Champagne Push/Pull is standard on bronze doors.

Page Left Intentionally Blank

### GLASS SIZES FOR SERIES 281, SERIES 381 AND SERIES 581 IMPACT ENTRANCE DOORS

DOOR OPENING	STILE TYPE	TOP RAIL (PART NUMBER)	TOP RAIL HEIGHT	BOTTOM RAIL (PART NUMBER)	BOTTOM RAIL HEIGHT	STILE WIDTH	GLASS SIZE
3684 or 7284	NS281	D101	2 ¼"	D102	4"	2 ⅝"	31 ⅛" x 76 ½"
3684 or 7284	NS281	D102	4"	D102	4"	2 ⅝"	31 ⅛" x 74 ¾"
3684 or 7284	NS281	D101	2 ¼"	D108	7 ½"	2 ⅝"	31 ⅛" x 73"
3684 or 7284	NS281	D101	4"	D109	9 ½"	2 ⅝"	31 ⅛" x 71"
3684 or 7284	MS381	D102	4"	D108	7 ½"	3 ¾"	27 ⅞" x 71 ¼"
3684 or 7284	WS581	D102	4"	D108	7 ½"	5"	25 ⅜" x 71 ¼"
3684 or 7284	MS381	D102	4"	D109	9 ½"	3 ¾"	27 ⅞" x 69 ¼"
3684 or 7284	WS581	D102	4"	D109	9 ½"	5"	25 ⅜" x 69 ¼"
4284 or 8484	MS381	D102	4"	D108	7 ½"	3 ¾"	33 ⅞" x 71 ¼"
4284 or 8484	WS581	D102	4"	D108	7 ½"	5"	31 ⅜" x 71 ¼"
4284 or 8484	MS381	D102	4"	D109	9 ½"	3 ¾"	33 ⅞" x 69 ¼"
4284 or 8484	WS581	D102	4"	D109	9 ½"	5"	31 ⅜" x 69 ¼"

### GLASS WIDTH FORMULAS (inches)

SINGLE or PAIR	FORMULA
Single	NS281= D.O.W. minus 4 ⅞"
Pair	NS281= D.O.W. divided by 2 minus 4 ⅞"
Single	MS381= D.O.W. minus 8 ⅞"
Pair	MS381= D.O.W. divided by 2 minus 8 ⅞"
Single	WS581= D.O.W. minus 10 ⅝"
Pair	WS581= D.O.W. divided by 2 minus 10 ⅝"

Note: D.O.W. = Door Opening Width

### GLASS HEIGHT FORMULAS (inches)

STEP #			EXAMPLE	
1)	D.O.W. Door Height dimension specified is:		84"	
2)	Deduct clearance at Door Frame Header:	- ⅛"	(- ⅛")	N/A
3)	Deduct Top Rail dimension:	Select	(4")	Part # = (D102)
4)	Deduct Bottom Rail dimension:	Select	(7 ½")	Part # = (D108)
5)	Deduct clearance between Bottom of Door and Top of Threshold:	- ⅜"	(- ⅜")	N/A
6)	Deduct for height of Threshold:	- ½"	(- ½")	Part # = (TH4)
7)	Deduct for Glass Bite and Setting Block:	- ⅞"	(- ⅞")	N/A
Note: D.O.H. = Door Opening Height		Glass Height	(71 ¼")	

Page Left Intentionally Blank



Butt Hinge

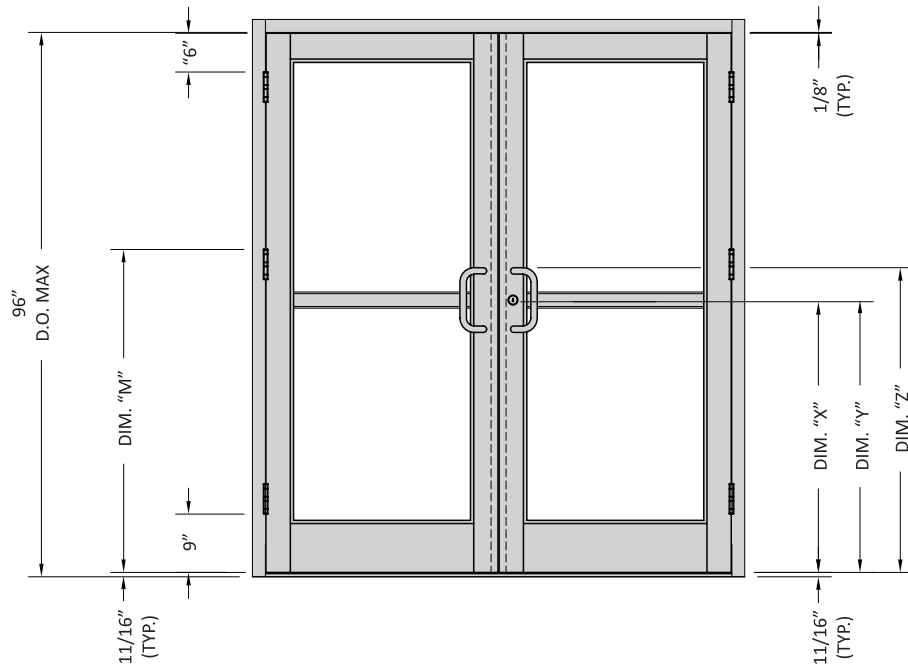

INTERMEDIATE HINGE	
D.O. HEIGHT	DIM. "M"
	BUTT HINGE
84"	45 <sup>11</sup> / <sub>32</sub> "
96"	51 <sup>11</sup> / <sub>32</sub> "

**Note:** All Impact doors require 1-½ pair butt hinges. Impact doors with 1" glazing and > 84" require 2 pair butt hinges.

HARDWARE LOCATIONS FOR PANIC DOORS				
MANUFACTURER	PANIC DEVICE	DIM "X" OF CYLINDER	DIM "Y" OF PANIC	DIM "Z" TOP OF PULL
FIRST CHOICE	3190 C.V.R.	39 <sup>5</sup> / <sub>32</sub> "	41 <sup>3</sup> / <sub>32</sub> "	44 <sup>5</sup> / <sub>32</sub> "
FIRST CHOICE	3692 C.V.R.	41 <sup>9</sup> / <sub>16</sub> "	40 <sup>5</sup> / <sub>8</sub> "	46 <sup>9</sup> / <sub>16</sub> "

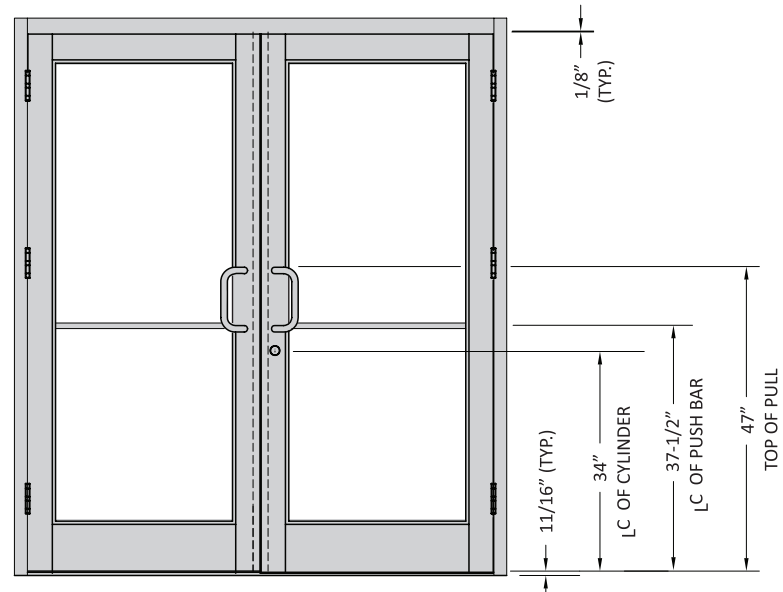

Note: Medium Stile Doors used for Illustration Purposes. Hardware locations are similar for Narrow and Wide Stile Doors

Page Left Intentionally Blank

## **Impact-Resistant Entrances & Frames**

### **NOTES AND POLICIES COMMON TO EACH PRODUCT**

(Unless otherwise specified)

- Series 281 Narrow Stile Door size may not exceed 36" x 84" for single and 72" x 84" for pairs.
- Series 381 Medium Stile Door size may not exceed 42" x 96" for single and 84" x 96" for pairs.
- Series 581 Wide Stile Door size may not exceed 42" x 96" for single and 84" x 96" for pairs.
- Reference Options and Limitations for Series 281, 381 and 581 Impact-Resistant Doors.
- SWING-IN DOORS ARE NOT OFFERED FOR IMPACT APPLICATIONS.
- DOOR JAMBS AT WALL REQUIRE FL515 FLAT FILLER WHICH IS NOT INCLUDED IN FRAME PACKAGE.
- TH4 mill finish threshold is standard on all doors without a panic device.
- TH5B bumper threshold is standard on doors with panic devices.
- Allow additional time for these doors and frames.
- Heavy duty closers are required for impact doors due to extra weight and size.
- Doors were not tested for water infiltration.
- All Impact doors require 1-½ pair butt hinges.
- Impact doors with 1" glazing and > 84" DOH (Door Opening Height) require 2 pair butt hinges.

Page Left Intentionally Blank

## High Velocity Hurricane Zone (HVHZ) Applications

### Series 281 Narrow Stile Impact-Resistant Entrances (Wet-Glazed)

#### Qualified System Configuration Chart

Design Pressure P.S.F.	Maximum Door Size		Maximum Glass Size		Qualified Glass Types
	Single	Double	D.L.O. (WxH)	Sq. Ft.	
Series 281 Narrow Stile - Large Missile					
+65/-65	36 x 84	72 x 84	29 $\frac{5}{16}$ " x 71 $\frac{3}{16}$ "	14.7	B

#### Hurricane Impact-Resistant Products Disclaimer Note

Coral's hurricane impact-resistant products meet a variety of test standards for applications in coastal construction regions satisfying the demands for wind-borne debris hazards and high-velocity winds associated with hurricanes. All of Coral's hurricane impact-resistant products are independent laboratory tested based on a variety of test standards for air infiltration, structural loads, missile impact and air-pressure cycling based on ASTM and/or Florida Building Code. The informational chart above is intended to provide recommended limits in frame heights, glass sizes and design pressures based on product testing. When exceeding conditions listed above it is recommended to consult with licensed structural engineer or contact Coral Architectural Products.

#### Hardware Applications

Locking and Closer Options		
Active Leaf	DH072 3-Point Lock with DH078 Cylinder and DH079 Thumbturn	
Inactive Leaf	DH176 Steel Tip Flush Bolts (2 each)	
Surface Applied Closer	Heavy Duty ANSI Grade 1 (Required)	
Concealed Overhead Closer	ANSI Grade 1 (Required)	
Hinging Options		
Type	Description	Quantity
Butt Hinges	DH110SS (Stainless Steel) 4 $\frac{1}{2}$ " x 4"	1 $\frac{1}{2}$ Pairs
Continuous Geared Hinge	DH111HD (Heavy Duty)	Full Door Height
Panic Exit Devices Options		
Jackson	2086-HR ANSI Grade 1	Concealed Vertical Rod

#### Qualified Glass Types

Glass Type	Glass Composition			Interlayer Manufacturer	Glass Identification
	Exterior Lite	Interlayer	Interior Lite		
$\frac{3}{16}$ " Monolithic Glass	$\frac{1}{4}$ " Heat Strengthened Glass	.090 Saflex PVB Interlayer	$\frac{1}{4}$ " Heat Strengthened Glass	Solutia	B

## High Velocity Hurricane Zone (HVHZ) Applications

### Series 381 Medium Stile Impact-Resistant Entrances (Wet-Glazed)

#### Qualified System Configuration Chart

Design Pressure P.S.F.	Maximum Door Size		Maximum Glass Size		Qualified Glass Types
	Single	Double	D.L.O. (WxH)	Sq. Ft.	
Series 381 Medium Stile - Large Missile Impact					
+70/-70	42 x 96	84 x 96	32 <sup>5</sup> / <sub>16</sub> " x 81 <sup>1</sup> / <sub>16</sub> "	18.3	A, B, C, D, IAD, IBD, IDD, IED

#### Hurricane Impact-Resistant Products Disclaimer Note

Coral's hurricane impact-resistant products meet a variety of test standards for applications in coastal construction regions satisfying the demands for wind-borne debris hazards and high-velocity winds associated with hurricanes. All of Coral's hurricane impact-resistant products are independent laboratory tested based on a variety of test standards for air infiltration, structural loads, missile impact and air-pressure cycling based on ASTM and/or Florida Building Code. The informational chart above is intended to provide recommended limits in frame heights, glass sizes and design pressures based on product testing. When exceeding conditions listed above it is recommended to consult with licensed structural engineer or contact Coral Architectural Products.

#### Hardware Applications

Locking and Closer Options		
Active Leaf	DH072 3-Point Lock with DH078 Cylinder and DH079 Thumbturn	
Inactive Leaf	DH176 Steel Tip Flush Bolts (2 each)	
Surface Applied Closer	Heavy Duty ANSI Grade 1 (Required)	
Concealed Overhead Closer	ANSI Grade 1 (Required)	
Hinging Options		
Type	Description	Quantity
Butt Hinges	DH110SS (Stainless Steel) 4 <sup>1</sup> / <sub>2</sub> " x 4"	1 <sup>1</sup> / <sub>2</sub> Pairs
Continuous Geared Hinge	DH111HD (Heavy Duty)	Full Door Height
Panic Exit Devices Options		
First Choice	DH3692 ANSI Grade 1	Concealed Vertical Rod
First Choice	DH3192 ANSI Grade 1	Mid Panel Panic
Jackson	DH2086 ANSI Grade 1	Concealed Vertical Rod

#### Qualified Glass Types

Glazing Schedule			Glazing Schedule Insulated		
Glass Mark Symbol	Glass Type	Manufacturer	Glass Mark Symbol	Glass Type	Manufacturer
A	.25HS x VS02(Vanceva) .075 x .25HS	Solutia	IAD	3/16" HS x 1/4" ABS x 3/16" HS x VS02(Vanceva) .075 x 1/4" HS	Solutia
B	.25HS x .090 Saflex x .25HS	Solutia	IBD	3/16" HS x 1/4" ABS x 3/16" HS x .090 Saflex x 1/4" HS	Solutia
C	.25HS x .090 Sentry GLAS x .25HS	Kuraray	IDD	3/16" HS x 1/4" ABS x 3/16" HS x .090 Sentry Glas x 1/4" HS	Kuraray
D	.25HS x .090 Butcite x .25HS	Kuraray	IED	3/16" HS x 1/4" ABS x 3/16" HS x .090 Butcite x 1/4" HS	Kuraray

## High Velocity Hurricane Zone (HVHZ) Applications

### Series 381 Medium Stile Impact-Resistant Entrances (Dry-Glazed)

**Qualified System Configuration Chart**

Design Pressure P.S.F.	Maximum Door Size		Maximum Glass Size		Qualified Glass Types
	Single	Double	D.L.O. (WxH)	Sq. Ft.	
Series 381 Medium Stile - Large Missile Impact					
+70/-70	36 x 84	72 x 84	26 <sup>5</sup> / <sub>16</sub> " x 69 <sup>1</sup> / <sub>16</sub> "	12.7	D

**Hurricane Impact-Resistant Products Disclaimer Note**

Coral's hurricane impact-resistant products meet a variety of test standards for applications in coastal construction regions satisfying the demands for wind-borne debris hazards and high-velocity winds associated with hurricanes. All of Coral's hurricane impact-resistant products are independent laboratory tested based on a variety of test standards for air infiltration, structural loads, missile impact and air-pressure cycling based on ASTM and/or Florida Building Code. The informational chart above is intended to provide recommended limits in frame heights, glass sizes and design pressures based on product testing. When exceeding conditions listed above it is recommended to consult with licensed structural engineer or contact Coral Architectural Products.

### Hardware Applications

Locking and Closer Options		
Active Leaf	DH072 3-Point Lock with DH078 Cylinder and DH079 Thumbturn	
Inactive Leaf	DH176 Steel Tip Flush Bolts (2 each)	
Surface Applied Closer	Heavy Duty ANSI Grade 1 (Required)	
Concealed Overhead Closer	ANSI Grade 1 (Required)	
Hinging Options		
Type	Description	Quantity
Butt Hinges	DH110SS (Stainless Steel) 4 <sup>1</sup> / <sub>2</sub> " x 4"	1 <sup>1</sup> / <sub>2</sub> Pairs
Continuous Geared Hinge	DH111HD (Heavy Duty)	Full Door Height
Panic Exit Devices Options		
First Choice	DH3692 ANSI Grade 1	Concealed Vertical Rod
First Choice	DH3192 Midpanel	Concealed Vertical Rod
Jackson	DH2086 ANSI Grade 1	Concealed Vertical Rod

### Qualified Glass Types

Glass Type	Glass Composition			Interlayer Manufacturer	Glass Identification
	Exterior Lite	Interlayer	Interior Lite		
<sup>5</sup> / <sub>16</sub> " Monolithic Glass	<sup>1</sup> / <sub>4</sub> " Heat Strengthened Glass	.090 SentryGlas	<sup>1</sup> / <sub>4</sub> " Heat Strengthened Glass	Kuraray	D

## High Velocity Hurricane Zone (HVHZ) Applications

### Series 581 Wide Stile Impact-Resistant Entrances (Wet-Glazed)

#### Qualified System Configuration Chart

Design Pressure P.S.F.	Maximum Door Size		Maximum Glass Size		Qualified Glass Types
	Single	Double	D.L.O. (WxH)	Sq. Ft.	
Series 581 Wide Stile - Large Missile Impact					
+70/-70	42 x 96	84 x 96	29 <sup>13</sup> / <sub>16</sub> " x 81 <sup>1</sup> / <sub>16</sub> "	16.9	A, B, C, D, IAD, IBD, IDD, IED

#### Hurricane Impact-Resistant Products Disclaimer Note

Coral's hurricane impact-resistant products meet a variety of test standards for applications in coastal construction regions satisfying the demands for wind-borne debris hazards and high-velocity winds associated with hurricanes. All of Coral's hurricane impact-resistant products are independent laboratory tested based on a variety of test standards for air infiltration, structural loads, missile impact and air-pressure cycling based on ASTM and/or Florida Building Code. The informational chart above is intended to provide recommended limits in frame heights, glass sizes and design pressures based on product testing. When exceeding conditions listed above it is recommended to consult with licensed structural engineer or contact Coral Architectural Products.

#### Hardware Applications

Locking and Closer Options		
Active Leaf	DH072 3-Point Lock with DH078 Cylinder and DH079 Thumbturn	
Inactive Leaf	DH176 Steel Tip Flush Bolts (2 each)	
Surface Applied Closer	Heavy Duty ANSI Grade 1 (Required)	
Concealed Overhead Closer	ANSI Grade 1 (Required)	
Hinging Options		
Type	Description	Quantity
Butt Hinges	DH110SS (Stainless Steel) 4 <sup>1</sup> / <sub>2</sub> " x 4"	1 <sup>1</sup> / <sub>2</sub> Pairs
Continuous Geared Hinge	DH111HD (Heavy Duty)	Full Door Height
Panic Exit Devices Options		
First Choice	DH3692 ANSI Grade 1	Concealed Vertical Rod
First Choice	DH3192 ANSI Grade 1	Mid Panel Panic
Jackson	DH2086 ANSI Grade 1	Concealed Vertical Rod

#### Qualified Glass Types

Glazing Schedule			Glazing Schedule Insulated		
Glass Mark Symbol	Glass Type	Manufacturer	Glass Mark Symbol	Glass Type	Manufacturer
A	.25HS x VS02(Vanceva) .075 x .25HS	Solutia	IAD	3/16" HS x 1/4" ABS x 3/16" HS x VS02(Vanceva) .075 x 1/4" HS	Solutia
B	.25HS x .090 Saflex x .25HS	Solutia	IBD	3/16" HS x 1/4" ABS x 3/16" HS x .090 Saflex x 1/4" HS	Solutia
C	.25HS x .090 Sentry GLAS x .25HS	Kuraray	IDD	3/16" HS x 1/4" ABS x 3/16" HS x .090 Sentry Glas x 1/4" HS	Kuraray
D	.25HS x .090 Butcite x .25HS	Kuraray	IED	3/16" HS x 1/4" ABS x 3/16" HS x .090 Butcite x 1/4" HS	Kuraray



## High Velocity Hurricane Zone (HVHZ) Applications

### Series 581 Wide Stile Impact-Resistant Entrances (Dry-Glazed)

#### Qualified System Configuration Chart

Design Pressure P.S.F.	Maximum Door Size		Maximum Glass Size		Qualified Glass Types
	Single	Double	D.L.O. (WxH)	Sq. Ft.	
Series 581 Wide Stile - Large Missile Impact					
+70/-70	42 x 96	84 x 96	29 <sup>13</sup> / <sub>16</sub> " x 81 <sup>1</sup> / <sub>16</sub> "	16.9	D

#### Hurricane Impact-Resistant Products Disclaimer Note

Coral's hurricane impact-resistant products meet a variety of test standards for applications in coastal construction regions satisfying the demands for wind-borne debris hazards and high-velocity winds associated with hurricanes. All of Coral's hurricane impact-resistant products are independent laboratory tested based on a variety of test standards for air infiltration, structural loads, missile impact and air-pressure cycling based on ASTM and/or Florida Building Code. The informational chart above is intended to provide recommended limits in frame heights, glass sizes and design pressures based on product testing. When exceeding conditions listed above it is recommended to consult with licensed structural engineer or contact Coral Architectural Products.

#### Hardware Applications

Locking and Closer Options		
Active Leaf	DH072 3-Point Lock with DH078 Cylinder and DH079 Thumbturn	
Inactive Leaf	DH176 Steel Tip Flush Bolts (2 each)	
Surface Applied Closer	Heavy Duty ANSI Grade 1 (Required)	
Concealed Overhead Closer	ANSI Grade 1 (Required)	
Hinging Options		
Type	Description	Quantity
Butt Hinges	DH110SS (Stainless Steel) 4 <sup>1</sup> / <sub>2</sub> " x 4"	1 <sup>1</sup> / <sub>2</sub> Pairs
Continuous Geared Hinge	DH111HD (Heavy Duty)	Full Door Height
Panic Exit Devices Options		
First Choice	DH3692 ANSI Grade 1	Concealed Vertical Rod
First Choice	DH3192 ANSI Grade 1	Mid Panel Panic
Jackson	DH2086 ANSI Grade 1	Concealed Vertical Rod

#### Qualified Glass Types

Glass Type	Glass Composition			Interlayer Manufacturer	Glass Identification
<sup>3</sup> / <sub>16</sub> " Monolithic Glass	<sup>1</sup> / <sub>4</sub> " Heat Strengthened Glass	.090 SentryGlas	<sup>1</sup> / <sub>4</sub> " Heat Strengthened Glass	Kuraray	D

# Impact Entrances

## Butt Hinge

### Butt Hinge Door Package Includes

- Traditional 1" rd Pull/Push Hardware
- Glass Stops for 3/4" or 1" Glazing
- 1 1/2 Pair 4 1/2" x 4" SS Butt Hinges
- 3 Pt Lock - Single or Active Leaf
- Top & Bottom Steel Flush Bolts Inactive Leaf
- Keyed Cylinder Exterior
- Thumb Turn Interior
- Door Sweep w/ Weathering

Note: Reference Hardware Section of the Price Catalog for Door Closers and Loose Hardware Items not included in Standard Entrance section.

Note: All Hardware on Powder coat products is furnished in a standard clear finish.



Order Number Example: **3684HR-B** (Size and Series) - (Hand or Pair)

SERIES 281 NARROW STILE						
HAND	DESCRIPTION	FINISH CODE / DOOR PRICE				
		#11 CLEAR	#21 BRONZE	#81 WHITE	#2604 POWDER	#2605 POWDER
RH	3684HN-A	\$1,057	\$1,078	\$1,078	\$1,206	\$1,272
LH	3684HN-B	\$1,057	\$1,078	\$1,078	\$1,206	\$1,272
PAIR	7284HN-J	\$2,039	\$2,100	\$2,100	\$2,317	\$2,432



SERIES 381 MEDIUM STILE						
HAND	DESCRIPTION	FINISH CODE / DOOR PRICE				
		#11 CLEAR	#21 BRONZE	#81 WHITE	#2604 POWDER	#2605 POWDER
RH	3684HR-A	\$1,104	\$1,134	\$1,134	\$1,270	\$1,342
LH	3684HR-B	\$1,104	\$1,134	\$1,134	\$1,270	\$1,342
RH	4284HR-A	\$1,148	\$1,169	\$1,169	\$1,325	\$1,400
LH	4284HR-B	\$1,148	\$1,169	\$1,169	\$1,325	\$1,400
PAIR	7284HR-J	\$2,134	\$2,198	\$2,198	\$2,464	\$2,595



SERIES 581 WIDE STILE						
HAND	DESCRIPTION	FINISH CODE / DOOR PRICE				
		#11 CLEAR	#21 BRONZE	#81 WHITE	#2604 POWDER	#2605 POWDER
RH	3684HS-A	\$1,134	\$1,166	\$1,166	\$1,316	\$1,393
LH	3684HS-B	\$1,134	\$1,166	\$1,166	\$1,316	\$1,393
RH	4284HS-A	\$1,179	\$1,200	\$1,200	\$1,372	\$1,454
LH	4284HS-B	\$1,179	\$1,200	\$1,200	\$1,372	\$1,454
PAIR	7284HS-J	\$2,196	\$2,260	\$2,260	\$2,558	\$2,729

Note: Add "DM141" to substitute Glass Stops used for 1" Insulated Glass.

**Butt Hinge Frame Package Includes**

- 2½" x 5" Open Back Frame
- Snap-in DS501 Door Stop w/pile
- ½" x 4" Threshold – Mill Finish
- Threshold Clips
- Prep for 1½ Pair 4½" x 4" SS Butt Hinges
- Prep for 3 Pt Lock
- Prep for Top & Bottom Flush Bolts (pair)
- Transom Frames include FL517(Sash) and FL518(Stop) for Wet Glaze
- Frame assembly fastener package

*Note: All Hardware on Powder coat products is furnished in a standard clear finish.*

*Note: Standard Frame Height for Transom Frames = 10'.*

*Order Number Example: 3684-B-FT5 (Size) - (Hand or Pair) - (Type)*

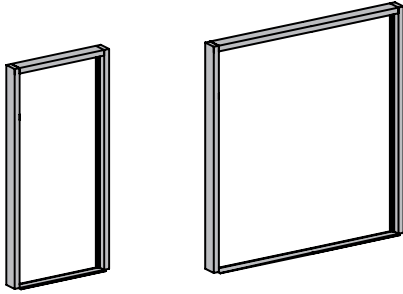

FL500 DOOR FRAME (Non-Transom)						
HAND	DESCRIPTION	FINISH CODE / FRAME PRICE				
		#11 CLEAR	#21 BRONZE	#81 WHITE	#2604 POWDER	#2605 POWDER
RH	3684-A-F5	\$576	\$589	\$589	\$670	\$707
LH	3684-B-F5	\$576	\$589	\$589	\$670	\$707
RH	4284-A-F5	\$594	\$607	\$607	\$692	\$730
LH	4284-B-F5	\$594	\$607	\$607	\$692	\$730
PAIR	7284-J-F5	\$698	\$713	\$713	\$915	\$981

**Note:** Maximum Frame Height = 120"

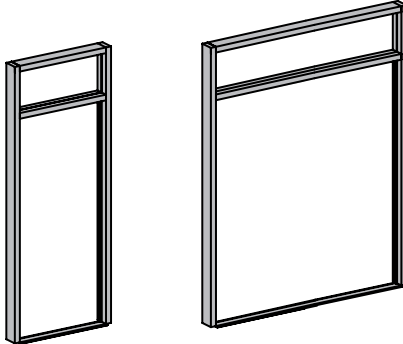

FL500 DOOR FRAME WITH TRANSOM						
HAND	DESCRIPTION	FINISH CODE / FRAME PRICE				
		#11 CLEAR	#21 BRONZE	#81 WHITE	#2604 POWDER	#2605 POWDER
RH	3684-A-FT5	\$864	\$886	\$886	\$1,057	\$1,125
LH	3684-B-FT5	\$864	\$886	\$886	\$1,057	\$1,125
RH	4284-A-FT5	\$885	\$908	\$908	\$1,087	\$1,157
LH	4284-B-FT5	\$885	\$908	\$908	\$1,087	\$1,157
PAIR	7284-J-FT5	\$1,024	\$1,049	\$1,049	\$1,233	\$1,336

**Note:** All FL581 Doorframes requiring sidelites are interchangeable with Series FL550 Framing System by using FL555 Snap-In Filler.

# Impact Entrances

## Butt Hinge

### Butt Hinge – Door Package Includes

- Traditional 1" rd Pull/Push Hardware
- Glass Stops for ¾" or 1" Glazing
- 1½ Pair 4½" x 4" SS Butt Hinges
- 3 Pt Lock - Single or Active Leaf
- Top & Bottom Steel Flush Bolts Inactive Leaf
- Keyed Cylinder Exterior
- Thumb Turn Interior
- Door Sweep w/ Weathering

Note: Reference Hardware Section of the Price Catalog for Door Closers and Loose Hardware Items not included in Standard Entrance section.

Note: All Hardware on Powder coat products is furnished in a standard clear finish.

Note: 2 pair of Butt Hinges required with 1" glazing.



Order Number Example: **3696HR-A** (Size and Series) - (Hand or Pair)

SERIES 381 MEDIUM STILE						
HAND	DESCRIPTION	FINISH CODE / DOOR PRICE				
		#11 CLEAR	#21 BRONZE	#81 WHITE	#2604 POWDER	#2605 POWDER
RH	3696HR-A	\$1,140	\$1,173	\$1,173	\$1,327	\$1,406
LH	3696HR-B	\$1,140	\$1,173	\$1,173	\$1,325	\$1,400
RH	4296HR-A	\$1,189	\$1,211	\$1,211	\$1,386	\$1,469
LH	4296HR-B	\$1,189	\$1,211	\$1,211	\$1,386	\$1,469
PAIR	7296HR-J	\$2,217	\$2,282	\$2,282	\$2,585	\$2,729



Order Number Example: **3696HS-A** (Size and Series) - (Hand or Pair)

SERIES 581 WIDE STILE						
HAND	DESCRIPTION	FINISH CODE / DOOR PRICE				
		#11 CLEAR	#21 BRONZE	#81 WHITE	#2604 POWDER	#2605 POWDER
RH	3696HS-A	\$1,176	\$1,209	\$1,209	\$1,383	\$1,468
LH	3696HS-B	\$1,176	\$1,209	\$1,209	\$1,383	\$1,468
RH	4296HS-A	\$1,225	\$1,249	\$1,249	\$1,442	\$1,531
LH	4296HS-B	\$1,225	\$1,249	\$1,249	\$1,442	\$1,531
PAIR	7296HS-J	\$2,288	\$2,354	\$2,354	\$2,697	\$2,852

Note: Add "DM141" to substitute Glass Stops used for 1" Insulated Glass.

**Butt Hinge Frame Package Includes**

- 2½" x 5" n Back Frame
- Snap-in DS501 Door Stop w/pile
- ½" x 4" Threshold – Mill Finish
- Threshold Clips
- Prep for 1½ Pair 4½" x 4" SS Butt Hinges
- Prep for 3 Pt Lock
- Prep for Top & Bottom Flush Bolts (pair)
- Transom Frames include FL517 (Sash) and FL518(Stop) for Wet Glaze
- Frame assembly fastener package

*Note: All Hardware on Powder coat products is furnished in a standard clear finish.*

*Note: Standard Frame Height for Transom Frames = 10'.*

Order Number Example: **3696-B-FT5** (Size) - (Hand or Pair) - (Type)

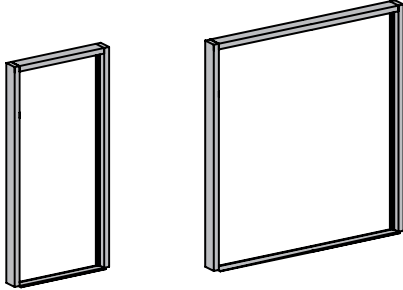

FL500 DOOR FRAME (Non-Transom)						
HAND	DESCRIPTION	FINISH CODE / FRAME PRICE				
		#11 CLEAR	#21 BRONZE	#81 WHITE	#2604 POWDER	#2605 POWDER
RH	3696-A-F5	\$611	\$625	\$625	\$716	\$758
LH	3696-B-F5	\$611	\$625	\$625	\$716	\$758
RH	4296-A-F5	\$627	\$643	\$643	\$738	\$782
LH	4296-B-F5	\$627	\$643	\$643	\$738	\$782
PAIR	7296-J-F5	\$733	\$749	\$749	\$943	\$1,012

**Note:** Maximum Frame Height = 120"

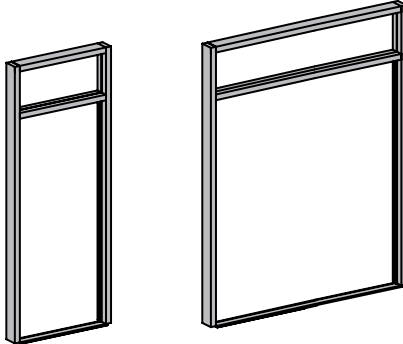

FL500 DOOR FRAME WITH TRANSOM						
HAND	DESCRIPTION	FINISH CODE / FRAME PRICE				
		#11 CLEAR	#21 BRONZE	#81 WHITE	#2604 POWDER	#2605 POWDER
RH	3696-A-FT5	\$860	\$882	\$882	\$1,034	\$1,097
LH	3696-B-FT5	\$860	\$882	\$882	\$1,034	\$1,097
RH	4296-A-FT5	\$881	\$903	\$903	\$1,063	\$1,127
LH	4296-B-FT5	\$881	\$903	\$903	\$1,063	\$1,127
PAIR	7296-J-FT5	\$1,020	\$1,046	\$1,046	\$1,219	\$1,318

**Note:** All FL581 Door frames requiring sidelites are interchangeable with Series FL550 Framing System by using FL555 Snap-In Filler.

# Impact Entrances

## Butt Hinge/Panic

**Butt Hinge CVR Panic Door Package Includes**

- Traditional 1" rd rd Panic Pull
- Glass Stops for 3/8" Glazing
- 1 1/2 Pair 4 1/2" x 4" SS Butt Hinges
- DH3692 CVR Touch Bar Panic(s)
- Keyed Cylinder Exterior
- Door Sweep w/ Weathering

*Note: Reference Hardware Section of the Price Catalog for Door Closers and Loose Hardware Items not included in Standard Entrance section.*

*Note: All Hardware on Powder coat products is furnished in a standard clear finish.*



Order Number Example: **3684HR-BP** (Size and Series) - (Hand or Pair)

SERIES 281 NARROW STILE						
HAND	DESCRIPTION	FINISH CODE / DOOR PRICE				
		#11 CLEAR	#21 BRONZE	#81 WHITE	#2604 POWDER	#2605 POWDER
RH	3684HN-AP	\$2,081	\$2,177	\$2,177	\$2,260	\$2,332
LH	3684HN-BP	\$2,081	\$2,177	\$2,177	\$2,260	\$2,332
PAIR	7284HN-JP	\$4,163	\$4,355	\$4,355	\$4,450	\$4,565



SERIES 381 MEDIUM STILE						
HAND	DESCRIPTION	FINISH CODE / DOOR PRICE				
		#10 CLEAR	#20 BRONZE	#81 WHITE	#2604 POWDER	#2605 POWDER
RH	3684HR-AP	\$1,458	\$1,473	\$1,473	\$1,616	\$1,687
LH	3684HR-BP	\$1,458	\$1,473	\$1,473	\$1,616	\$1,687
RH	4284HR-AP	\$1,483	\$1,499	\$1,499	\$1,654	\$1,729
LH	4284HR-BP	\$1,483	\$1,499	\$1,499	\$1,654	\$1,729
PAIR	7284HR-JP	\$2,949	\$2,983	\$2,983	\$3,261	\$3,393



SERIES 581 WIDE STILE						
HAND	DESCRIPTION	FINISH CODE / DOOR PRICE				
		#11 CLEAR	#21 BRONZE	#81 WHITE	#2604 POWDER	#2605 POWDER
RH	3684HS-AP	\$1,487	\$1,504	\$1,504	\$1,662	\$1,739
LH	3684HS-BP	\$1,487	\$1,504	\$1,504	\$1,662	\$1,739
RH	4284HS-AP	\$1,515	\$1,530	\$1,530	\$1,701	\$1,783
LH	4284HS-BP	\$1,515	\$1,530	\$1,530	\$1,701	\$1,783
PAIR	7284HS-JP	\$3,009	\$3,043	\$3,043	\$3,356	\$3,496

*Note: Add "DM141" to substitute Glass Stops used for 1" Insulated Glass.*

**Butt Hinge CVR Panic Frame Package Includes**

- 2½" x 5" n Back Frame
- Snap-in DS501 Door Stop w/pile
- ½" x 5" Bumper Threshold – Mill Finish
- Threshold Clips
- Prep for 1½ Pair 4½" x 4" SS Butt Hinges
- Prep for DH3692 CVR Panic(s)
- Transom Frames include FL517(Sash) and FL518(Stop) for Wet Glaze
- Frame assembly fastener package

*Note: All Hardware on Powder coat products is furnished in a standard clear finish.*

*Note: Standard Frame Height for Transom Frames = 10'.*

Order Number Example: **3684-BP-FT5 (Size) - (Hand or Pair) - (Type)**

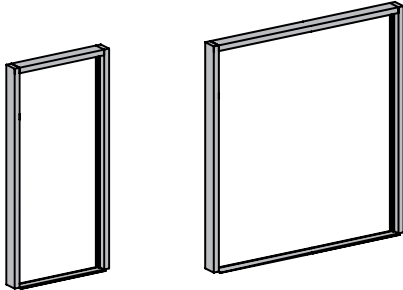

FL500 DOOR FRAME (Non-Transom)						
HAND	DESCRIPTION	FINISH CODE / FRAME PRICE				
		#11 CLEAR	#21 BRONZE	#81 WHITE	#2604 POWDER	#2605 POWDER
RH	3684-AP-F5	\$586	\$599	\$599	\$679	\$717
LH	3684-BP-F5	\$586	\$599	\$599	\$679	\$717
RH	4284-AP-F5	\$594	\$608	\$608	\$693	\$731
LH	4284-BP-F5	\$594	\$608	\$608	\$693	\$731
PAIR	7284-JP-F5	\$706	\$723	\$723	\$905	\$970

**Note:** Maximum Frame Height = 120"

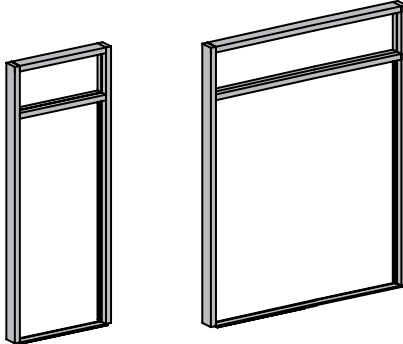

FL500 DOOR FRAME WITH TRANSOM						
HAND	DESCRIPTION	FINISH CODE / FRAME PRICE				
		#11 CLEAR	#21 BRONZE	#81 WHITE	#2604 POWDER	#2605 POWDER
RH	3684-AP-FT5	\$874	\$896	\$896	\$1,066	\$1,133
LH	3684-BP-FT5	\$874	\$896	\$896	\$1,066	\$1,133
RH	4284-AP-FT5	\$895	\$918	\$918	\$1,095	\$1,165
LH	4284-BP-FT5	\$895	\$918	\$918	\$1,095	\$1,165
PAIR	7284-JP-FT5	\$1,034	\$1,061	\$1,061	\$1,253	\$1,356

**Note:** All FL581 Door frames requiring sidelites are interchangeable with Series FL550 Framing System by using FL555 Snap-In Filler.

# Impact Entrances

## Butt Hinge/Panic

### Butt Hinge CVR Panic Door Package Includes

- Traditional 1" round Panic Pull
- Glass Stops for 3/8" or 1" Glazing
- 1 1/2 Pair 4 1/2" x 4" SS Butt Hinges
- DH3692 CVR Touch Bar Panic(s)
- Keyed Cylinder Exterior
- Door Sweep w/ Weathering

Note: Reference Hardware Section of the Price Catalog for Door Closers and Loose Hardware Items not included in Standard Entrance section.

Note: All Hardware on Powder coat products is furnished in a standard clear finish.

Note: 2 pair of Butt Hinges required with 1" glazing.

Order Number Example: **3696HR-AP** (Size and Series) - (Hand or Pair)



### SERIES 381 MEDIUM STILE

HAND	DESCRIPTION	FINISH CODE / DOOR PRICE				
		#11 CLEAR	#21 BRONZE	#81 WHITE	#2604 POWDER	#2605 POWDER
RH	3696HR-AP	\$1,493	\$1,512	\$1,512	\$1,673	\$1,752
LH	3696HR-BP	\$1,493	\$1,512	\$1,512	\$1,673	\$1,752
RH	4296HR-AP	\$1,525	\$1,541	\$1,541	\$1,715	\$1,798
LH	4296HR-BP	\$1,525	\$1,541	\$1,541	\$1,715	\$1,798
PAIR	7296HR-JP	\$3,386	\$3,420	\$3,420	\$3,731	\$3,874

Order Number Example: **3696HS-AP** (Size and Series) - (Hand or Pair)



### SERIES 581 WIDE STILE

HAND	DESCRIPTION	FINISH CODE / DOOR PRICE				
		#11 CLEAR	#21 BRONZE	#81 WHITE	#2604 POWDER	#2605 POWDER
RH	3696HS-AP	\$1,529	\$1,547	\$1,547	\$1,729	\$1,813
LH	3696HS-BP	\$1,529	\$1,547	\$1,547	\$1,729	\$1,813
RH	4296HS-AP	\$1,561	\$1,579	\$1,579	\$1,771	\$1,860
LH	4296HS-BP	\$1,561	\$1,579	\$1,579	\$1,771	\$1,860
PAIR	7296HS-JP	\$3,099	\$3,137	\$3,137	\$3,490	\$3,646

Note: Add "DM141" to substitute Glass Stops used for 1" Insulated Glass.



**Butt Hinge CVR Panic Frame Package Includes**

- 2½" x 5" Open Back Frame
- Snap-in DS501 Door Stop w/pile
- ½" x 5" Bumper Threshold – Mill Finish
- Threshold Clips
- Prep for 1½ Pair 4½" x 4" SS Butt Hinges
- Prep for DH3692 CVR Panic(s)
- Transom Frames include FL517(Sash) and FL518(Stop) for Wet Glaze
- Frame assembly fastener package

*Note: All Hardware on Powder coat products is furnished in a standard clear finish.  
Note: Standard Frame Height for Transom Frames = 10".*

Order Number Example: **3696-BP-FT5** (Size) - (Hand or Pair) - (Type)

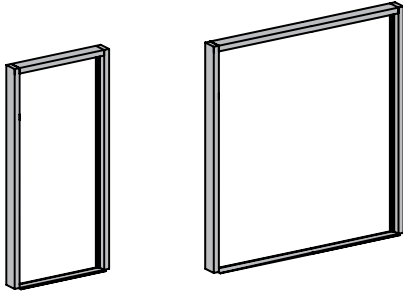

FL500 DOOR FRAME (Non-Transom)						
HAND	DESCRIPTION	FINISH CODE / FRAME PRICE				
		#11 CLEAR	#21 BRONZE	#81 WHITE	#2604 POWDER	#2605 POWDER
RH	3696-AP-F5	\$619	\$635	\$635	\$726	\$768
LH	3696-BP-F5	\$619	\$635	\$635	\$726	\$768
RH	4296-AP-F5	\$637	\$653	\$653	\$748	\$790
LH	4296-BP-F5	\$637	\$653	\$653	\$748	\$790
PAIR	7296-JP-F5	\$742	\$760	\$760	\$953	\$1,022

**Note:** Maximum Frame Height = 120"

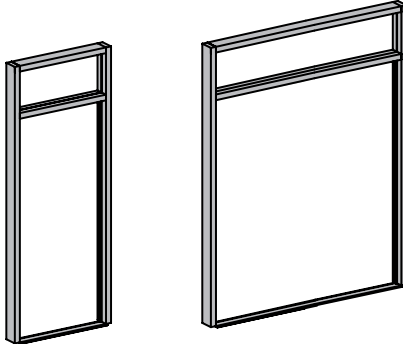

FL500 DOOR FRAME WITH TRANSOM						
HAND	DESCRIPTION	FINISH CODE / FRAME PRICE				
		#11 CLEAR	#21 BRONZE	#81 WHITE	#2604 POWDER	#2605 POWDER
RH	3696-AP-FT5	\$870	\$890	\$890	\$1,093	\$1,106
LH	3696-BP-FT5	\$870	\$890	\$890	\$1,093	\$1,106
RH	4296-AP-FT5	\$891	\$912	\$912	\$1,071	\$1,137
LH	4296-BP-FT5	\$891	\$912	\$912	\$1,071	\$1,137
PAIR	7296-JP-FT5	\$1,029	\$1,055	\$1,055	\$1,229	\$1,328

**Note:** All FL581 Door frames requiring sidelites are interchangeable with Series FL550 Framing System by using FL555 Snap-In Filler.

# Impact Entrances

## Butt Hinge/Offset Arm

**Butt Hinge – Offset Arm Door Package Includes**

- Traditional 1" rd Pull/Push Hardware
- Glass Stops for 5/8" 1" Glazing
- 1½ Pair 4½" x 4" SS Butt Hinges
- Slide Channel installed with Offset Arm
- 3 Pt Lock - Single or Active Leaf
- Top & Bottom Steel Flush Bolts Inactive Leaf
- Keyed Cylinder Exterior
- Thumb Turn Interior
- Door Sweep w/ Weathering

*Note: Reference Hardware Section of the Price Catalog for Door Closers and Loose Hardware Items not included in Standard Entrance section.  
Note: All Hardware on Powder coat products is furnished in a standard clear finish.*

Order Number Example: **3684HR-BO** (Size and Series) - (Hand or Pair)



SERIES 281 NARROW STILE						
HAND	DESCRIPTION	FINISH CODE / DOOR PRICE				
		#11 CLEAR	#21 BRONZE	#81 WHITE	#2604 POWDER	#2605 POWDER
RH	3684HN-AO	\$1,284	\$1,275	\$1,275	\$1,396	\$1,463
LH	3684HN-BO	\$1,284	\$1,275	\$1,275	\$1,396	\$1,463
PAIR	7284HN-JO	\$2,420	\$2,480	\$2,480	\$2,698	\$2,816



SERIES 381 MEDIUM STILE						
HAND	DESCRIPTION	FINISH CODE / DOOR PRICE				
		#11 CLEAR	#21 BRONZE	#81 WHITE	#2604 POWDER	#2605 POWDER
RH	3684HR-AO	\$1,283	\$1,313	\$1,313	\$1,446	\$1,518
LH	3684HR-BO	\$1,283	\$1,313	\$1,313	\$1,446	\$1,518
RH	4284HR-AO	\$1,328	\$1,346	\$1,346	\$1,501	\$1,577
LH	4284HR-BO	\$1,328	\$1,346	\$1,346	\$1,501	\$1,577
PAIR	7284HR-JO	\$2,494	\$2,554	\$2,554	\$2,817	\$2,947



SERIES 581 WIDE STILE						
HAND	DESCRIPTION	FINISH CODE / DOOR PRICE				
		#11 CLEAR	#21 BRONZE	#81 WHITE	#2604 POWDER	#2605 POWDER
RH	3684HS-AO	\$1,315	\$1,342	\$1,342	\$1,493	\$1,570
LH	3684HS-BO	\$1,315	\$1,342	\$1,342	\$1,493	\$1,570
RH	4284HS-AO	\$1,360	\$1,378	\$1,378	\$1,549	\$1,630
LH	4284HS-BO	\$1,360	\$1,378	\$1,378	\$1,549	\$1,630
PAIR	7284HS-JO	\$2,555	\$2,616	\$2,616	\$2,911	\$3,052

*Note: Add "DM141" to substitute Glass Stops used for 1" Insulated Glass.*

**Butt Hinge - Offset Arm Frame Package Includes**

- 2½" x 5" Open Back Frame
- Snap-in DS501 Door Stop w/pile
- Applied DS202 Header Door stop
- ½" x 4" Threshold – Mill Finish
- Threshold Clips
- Prep for 1½ Pair 4½" x 4" SS Butt Hinges
- Prep for 3 Pt Lock
- Prep for Top & Bottom Flush Bolts (pair)
- Prep for COC
- Transom Frames include FL517(Sash) and FL518 (Stop) for Wet Glaze
- Frame assembly fastener package

*Note: All Hardware on Powder coat products is furnished in a standard clear finish.*

*Note: Standard Frame Height for Transom Frames = 10'.*

Order Number Example: **3684-BO-FT5** (Size) - (Hand or Pair) - (Type)

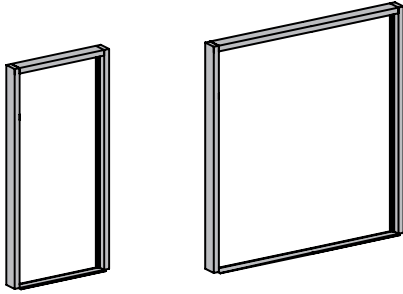

FL500 DOOR FRAME (Non-Transom)						
HAND	DESCRIPTION	FINISH CODE / FRAME PRICE				
		#11 CLEAR	#21 BRONZE	#81 WHITE	#2604 POWDER	#2605 POWDER
RH	3684-AO-F5	\$696	\$709	\$709	\$800	\$864
LH	3684-BO-F5	\$696	\$709	\$709	\$800	\$864
RH	4284-AO-F5	\$712	\$724	\$724	\$807	\$851
LH	4284-BO-F5	\$712	\$724	\$724	\$807	\$851
PAIR	7284-JO-F5	\$892	\$905	\$905	\$1,130	\$1,200

**Note:** Maximum Frame Height = 120"

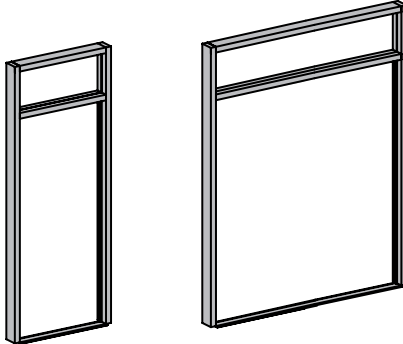

FL500 DOOR FRAME WITH TRANSOM						
HAND	DESCRIPTION	FINISH CODE / FRAME PRICE				
		#11 CLEAR	#21 BRONZE	#81 WHITE	#2604 POWDER	#2605 POWDER
RH	3684-AO-FT5	\$1,021	\$1,042	\$1,042	\$1,233	\$1,293
LH	3684-BO-FT5	\$1,021	\$1,042	\$1,042	\$1,233	\$1,293
RH	4284-AO-FT5	\$1,043	\$1,067	\$1,067	\$1,255	\$1,329
LH	4284-BO-FT5	\$1,043	\$1,067	\$1,067	\$1,255	\$1,329
PAIR	7284-JO-FT5	\$1,270	\$1,299	\$1,299	\$1,509	\$1,617

**Note:** All FL581 Door frames requiring sidelites are interchangeable with Series FL550 Framing System by using FL555 Snap-In Filler.

# Impact Entrances

## Butt Hinge/Offset Arm

**Butt Hinge – Offset Arm Door Package Includes**

- Traditional 1" rd Pull/Push Hardware
- Glass Stops for ¾" or 1" Glazing
- 1½ Pair 4½" x 4" SS Butt Hinges
- Slide Channel installed with Offset Arm
- 3 Pt Lock - Single or Active Leaf
- Top & Bottom Steel Flush Bolts Inactive Leaf
- Keyed Cylinder Exterior
- Thumb Turn Interior
- Door Sweep w/ Weathering

Note: Reference Hardware Section of the Price Catalog for Door Closers and Loose Hardware Items not included in Standard Entrance section.

Note: All Hardware on Powder coat products is furnished in a standard clear finish.

Note: 2 pair of Butt Hinges required with 1" glazing.

Order Number Example: **3696HR-AO** (Size and Series) - (Hand or Pair)



SERIES 381 MEDIUM STILE						
HAND	DESCRIPTION	FINISH CODE / DOOR PRICE				
		#11 CLEAR	#21 BRONZE	#81 WHITE	#2604 POWDER	#2605 POWDER
RH	3696HR-AO	\$1,321	\$1,350	\$1,350	\$1,504	\$1,582
LH	3696HR-BO	\$1,321	\$1,350	\$1,350	\$1,504	\$1,582
RH	4296HR-AO	\$1,370	\$1,389	\$1,389	\$1,563	\$1,645
LH	4296HR-BO	\$1,370	\$1,389	\$1,389	\$1,563	\$1,645
PAIR	7296HR-JO	\$2,576	\$2,637	\$2,637	\$2,933	\$3,082

Order Number Example: **3696HS-AO** (Size and Series) - (Hand or Pair)



SERIES 581 WIDE STILE						
HAND	DESCRIPTION	FINISH CODE / DOOR PRICE				
		#11 CLEAR	#21 BRONZE	#81 WHITE	#2604 POWDER	#2605 POWDER
RH	3696HS-AO	\$1,356	\$1,388	\$1,388	\$1,560	\$1,644
LH	3696HS-BO	\$1,356	\$1,388	\$1,388	\$1,560	\$1,644
RH	4296HS-AO	\$1,405	\$1,427	\$1,427	\$1,619	\$1,707
LH	4296HS-BO	\$1,405	\$1,427	\$1,427	\$1,619	\$1,707
PAIR	7296HS-JO	\$2,649	\$2,711	\$2,711	\$3,045	\$3,205

Note: Add "DM141" to substitute Glass Stops used for 1" Insulated Glass.

**Butt Hinge - Offset Arm Frame Package Includes**

- 2½" x 5" Open Back Frame
- Snap-in DS501 Door Stop w/pile
- Applied DS202 Header Door stop
- ½" x 4" Threshold – Mill Finish
- Threshold Clips
- Prep for 1½ Pair 4½" x 4" SS Butt Hinges
- Prep for 3 Pt Lock
- Prep for Top & Bottom Flush Bolts (pair)
- Prep for COC
- Transom Frames include FL517(Sash) and FL518(Stop) for Wet Glaze
- Frame assembly fastener package

*Note: All Hardware on Powder coat products is furnished in a standard clear finish.*

*Note: Standard Frame Height for Transom Frames = 10'.*

Order Number Example: **3696-BO-FT5** (Size) - (Hand or Pair) - (Type)

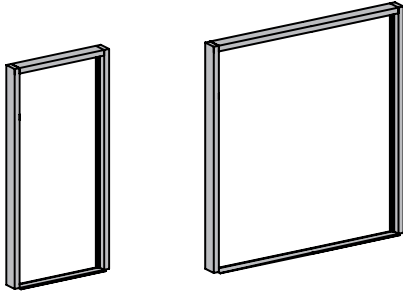

FL500 DOOR FRAME (Non-Transom)						
HAND	DESCRIPTION	FINISH CODE / FRAME PRICE				
		#11 CLEAR	#21 BRONZE	#81 WHITE	#2604 POWDER	#2605 POWDER
RH	3696-AO-F5	\$733	\$745	\$745	\$818	\$854
LH	3696-BO-F5	\$733	\$745	\$745	\$818	\$854
RH	4296-AO-F5	\$748	\$762	\$762	\$843	\$881
LH	4296-BO-F5	\$748	\$762	\$762	\$843	\$881
PAIR	7296-JO-F5	\$927	\$942	\$942	\$1,180	\$1,250

**Note:** Maximum Frame Height = 120"

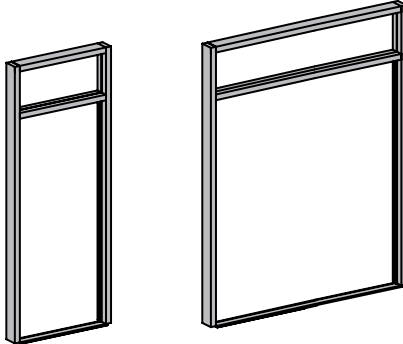

FL500 DOOR FRAME WITH TRANSOM						
HAND	DESCRIPTION	FINISH CODE / FRAME PRICE				
		#11 CLEAR	#21 BRONZE	#81 WHITE	#2604 POWDER	#2605 POWDER
RH	3696-AO-FT5	\$1,015	\$1,035	\$1,035	\$1,197	\$1,263
LH	3696-BO-FT5	\$1,015	\$1,035	\$1,035	\$1,197	\$1,263
RH	4296-AO-FT5	\$1,039	\$1,061	\$1,061	\$1,231	\$1,301
LH	4296-BO-FT5	\$1,039	\$1,061	\$1,061	\$1,231	\$1,301
PAIR	7296-JO-FT5	\$1,266	\$1,293	\$1,293	\$1,485	\$1,591

**Note:** All FL500 Doorframes requiring sidelites are interchangeable with Series FL550 Framing System by using FL555 Snap-In Filler.

# Impact Entrances

## Butt Hinge/Offset Arm/Panic



**Butt Hinge – CVR Panic – Offset Arm Door Package Includes**

- Traditional 1" rd rd Panic Pull
- Glass Stops for 3/8" or 1" Glazing
- 1½ Pair 4½" x 4" SS Butt Hinges
- Slide Channel installed with Offset Arm
- DH3692 CVR Touch Bar Panic(s)
- Keyed Cylinder Exterior - Single or Active Leaf
- Door Sweep w/ Weathering

*Note: Reference Hardware Section of the Price Catalog for Door Closers and Loose Hardware Items not included in Standard Entrance section.  
Note: All Hardware on Powder coat products is furnished in a standard clear finish.*

Order Number Example: **3684HR-BOP** (Size and Series) - (Hand or Pair)



SERIES 281 NARROW STILE						
HAND	DESCRIPTION	FINISH CODE / DOOR PRICE				
		#11 CLEAR	#21 BRONZE	#81 WHITE	#2604 POWDER	#2605 POWDER
RH	3684HN-AOP	\$2,267	\$2,366	\$2,366	\$2,410	\$2,470
LH	3684HN-BOP	\$2,267	\$2,366	\$2,366	\$2,410	\$2,470
PAIR	7284HN-JOP	\$4,536	\$4,735	\$4,735	\$4,822	\$4,940



SERIES 381 MEDIUM STILE						
HAND	DESCRIPTION	FINISH CODE / DOOR PRICE				
		#11 CLEAR	#21 BRONZE	#81 WHITE	#2604 POWDER	#2605 POWDER
RH	3684HR-AOP	\$1,637	\$1,650	\$1,650	\$1,792	\$1,864
LH	3684HR-BOP	\$1,637	\$1,650	\$1,650	\$1,792	\$1,864
RH	4284HR-AOP	\$1,664	\$1,678	\$1,678	\$1,830	\$1,906
LH	4284HR-BOP	\$1,664	\$1,678	\$1,678	\$1,830	\$1,906
PAIR	7284HR-JOP	\$3,309	\$3,337	\$3,337	\$3,614	\$3,745



SERIES 581 WIDE STILE						
HAND	DESCRIPTION	FINISH CODE / DOOR PRICE				
		#11 CLEAR	#21 BRONZE	#81 WHITE	#2604 POWDER	#2605 POWDER
RH	3684HS-AOP	\$1,668	\$1,682	\$1,682	\$1,838	\$1,916
LH	3684HS-BOP	\$1,668	\$1,682	\$1,682	\$1,838	\$1,916
RH	4284HS-AOP	\$1,694	\$1,709	\$1,709	\$1,878	\$1,959
LH	4284HS-BOP	\$1,694	\$1,709	\$1,709	\$1,878	\$1,959
PAIR	7284HS-JOP	\$3,369	\$3,400	\$3,400	\$3,707	\$3,849

*Note: Add "DM141" to substitute Glass Stops used for 1" Insulated Glass.*

**Butt hung – CVR Panic – Offset Arm Frame Package Includes**

- 2½" x 5" Open Back Frame
- Snap-in DS501 Door Stop w/pile
- Applied DS202 Header Door stop
- ½" x 5" Bumper Threshold – Mill Finish
- Threshold Clips
- Prep for 1½ Pair 4½" x 4" SS Butt Hinges
- Prep for DH3692 CVR Panic(s)
- Prep for COC
- Transom Frames include FL517(Sash) and FL518(Stop) for Wet Glaze
- Frame assembly fastener package

*Note: All Hardware on Powder coat products is furnished in a standard clear finish.*

*Note: Standard Frame Height for Transom Frames = 10'.*

Order Number Example: **3684-BOP-FT5 (Size) - (Hand or Pair) - (Type)**

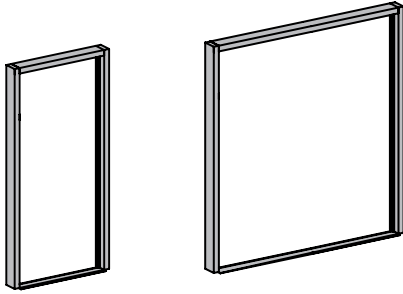

FL500 DOOR FRAME (Non-Transom)						
HAND	DESCRIPTION	FINISH CODE / FRAME PRICE				
		#11 CLEAR	#21 BRONZE	#81 WHITE	#2604 POWDER	#2605 POWDER
RH	3684-AOP-F5	\$706	\$719	\$719	\$800	\$875
LH	3684-BOP-F5	\$706	\$719	\$719	\$800	\$875
RH	4284-AOP-F5	\$723	\$734	\$734	\$817	\$851
LH	4284-BOP-F5	\$723	\$734	\$734	\$817	\$851
PAIR	7284-JOP-F5	\$902	\$915	\$915	\$1,130	\$1,200

**Note:** Maximum Frame Height = 120"

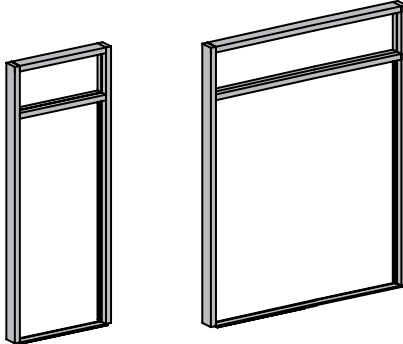

FL500 DOOR FRAME WITH TRANSOM						
HAND	DESCRIPTION	FINISH CODE / FRAME PRICE				
		#11 CLEAR	#21 BRONZE	#81 WHITE	#2604 POWDER	#2605 POWDER
RH	3684-AOP-FT5	\$1,031	\$1,052	\$1,052	\$1,232	\$1,302
LH	3684-BOP-FT5	\$1,031	\$1,052	\$1,052	\$1,232	\$1,302
RH	4284-AOP-FT5	\$1,053	\$1,075	\$1,075	\$1,265	\$1,339
LH	4284-BOP-FT5	\$1,053	\$1,075	\$1,075	\$1,265	\$1,339
PAIR	7284-JOP-FT5	\$1,280	\$1,307	\$1,307	\$1,519	\$1,627

**Note:** All FL581 Doorframes requiring sidelites are interchangeable with Series FL550 Framing System by using FL555 Snap-In Filler.



# Impact Entrances

## Butt Hinge/Offset Arm/Panic

**Butt Hinge – CVR Panic – Offset Arm Door Package Includes**

- Traditional 1" round Panic Pull
- Glass Stops for 3/8" Glazing
- 1 1/2 Pair 4 1/2" x 4" SS Butt Hinges
- Slide Channel installed with Offset Arm
- DH3692 CVR Touch Bar Panic(s)
- Keyed Cylinder Exterior - Single or Active Leaf
- Door Sweep w/ Weathering

Note: Reference Hardware Section of the Price Catalog for Door Closers and Loose Hardware Items not included in Standard Entrance section.

Note: All Hardware on Powder coat products is furnished in a standard clear finish.

Note: 2 pair of Butt Hinges required with 1" glazing.

Order Number Example: **3696HR-AOP** (Size and Series) - (Hand or Pair)



SERIES 381 MEDIUM STILE						
HAND	DESCRIPTION	FINISH CODE / DOOR PRICE				
		#11 CLEAR	#21 BRONZE	#81 WHITE	#2604 POWDER	#2605 POWDER
RH	3696HR-AOP	\$1,673	\$1,690	\$1,690	\$1,850	\$1,928
LH	3696HR-BOP	\$1,673	\$1,690	\$1,690	\$1,850	\$1,928
RH	4296HR-AOP	\$1,704	\$1,720	\$1,720	\$1,892	\$1,974
LH	4296HR-BOP	\$1,704	\$1,720	\$1,720	\$1,892	\$1,974
PAIR	7296HR-JOP	\$3,386	\$3,420	\$3,420	\$3,731	\$3,874

Order Number Example: **3696HS-AOP** (Size and Series) - (Hand or Pair)



SERIES 581 WIDE STILE						
HAND	DESCRIPTION	FINISH CODE / DOOR PRICE				
		#11 CLEAR	#21 BRONZE	#81 WHITE	#2604 POWDER	#2605 POWDER
RH	3696HS-AOP	\$1,709	\$1,727	\$1,727	\$1,887	\$1,965
LH	3696HS-BOP	\$1,709	\$1,727	\$1,727	\$1,887	\$1,965
RH	4296HS-AOP	\$1,740	\$1,757	\$1,757	\$1,929	\$2,011
LH	4296HS-BOP	\$1,740	\$1,757	\$1,757	\$1,929	\$2,011
PAIR	7296HS-JOP	\$3,421	\$3,455	\$3,455	\$3,768	\$3,911

Note: Add "DM141" to substitute Glass Stops used for 1" Insulated Glass.



**Butt hung – CVR Panic – Offset Arm Frame Package Includes**

- 2½" x 5" Open Back Frame
- Snap-in DS501 Door Stop w/pile
- Applied DS202 Header Door stop
- ½" x 5" Bumper Threshold – Mill Finish
- Threshold Clips
- Prep for 1½ Pair 4½" x 4" SS Butt Hinges
- Prep for DH3692 CVR Panic(s)
- Prep for COC
- Transom Frames include FL517(Sash) and FL518(Stop) for Wet Glaze
- Frame assembly fastener package

*Note: All Hardware on Powder coat products is furnished in a standard clear finish.  
Note: Standard Frame Height for Transom Frames = 10'.*

Order Number Example: **3696-BOP-FT5** (Size) - (Hand or Pair) - (Type)

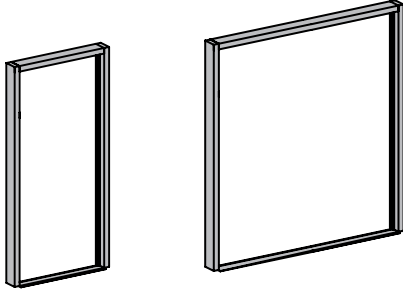

FL500 DOOR FRAME (Non-Transom)						
HAND	DESCRIPTION	FINISH CODE / FRAME PRICE				
		#11 CLEAR	#21 BRONZE	#81 WHITE	#2604 POWDER	#2605 POWDER
RH	3696-AOP-F5	\$742	\$755	\$755	\$828	\$864
LH	3696-AOP-F5	\$742	\$755	\$755	\$828	\$864
RH	4296-AOP-F5	\$758	\$771	\$771	\$853	\$891
LH	4296-BOP-F5	\$758	\$771	\$771	\$853	\$891
PAIR	7296-JOP-F5	\$938	\$952	\$952	\$1,180	\$1,266

**Note:** Maximum Frame Height = 120"

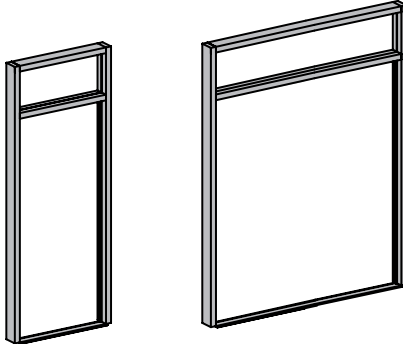

FL500 DOOR FRAME WITH TRANSOM						
HAND	DESCRIPTION	FINISH CODE / FRAME PRICE				
		#11 CLEAR	#21 BRONZE	#81 WHITE	#2604 POWDER	#2605 POWDER
RH	3696-AOP-FT5	\$1,031	\$1,052	\$1,052	\$1,232	\$1,302
LH	3696-BOP-FT5	\$1,031	\$1,052	\$1,052	\$1,232	\$1,302
RH	4296-AOP-FT5	\$1,049	\$1,071	\$1,071	\$1,241	\$1,309
LH	4296-BOP-FT5	\$1,049	\$1,071	\$1,071	\$1,241	\$1,309
PAIR	7296-JOP-FT5	\$1,276	\$1,303	\$1,303	\$1,495	\$1,601

**Note:** All FL500 Doorframes requiring sidelites are interchangeable with Series FL550 Framing System by using FL555 Snap-In Filler.

Page Left Intentionally Blank

Section D2  
Table of Contents



**IMPACT ENTRANCES**



**Adds, Substitutions, and Modifications**

Glass Stops .....	1
Push / Pulls .....	1
Top Rail Substitutions - Stock Door.....	2
Bottom Rail Substitutions - Stock Door .....	3
Horizontal Muntin Mid-Rail Adds - Standard Door .....	4
Hinge Modifications and Substitutions .....	5
Cylinder Substitutions .....	6
Panic / Exit Devices.....	7

Page Left Intentionally Blank

Note: Part Finish #11 = Clear & #21 Bronze

GLASS STOPS									
ITEM	DESCRIPTION	LENGTH	P/N	FINISH CODE / DOOR PRICE					
				#11	#21	#81	#99	#89	
DG505 	<b>Substitute</b> DG505 1" Glass Stops	N/A	DM006						N/C
	<b>Substitute</b> DG504 5/16" Dry Glaze	N/A	DM007						N/C



PUSH / PULL									
ITEM	DESCRIPTION	LENGTH	P/N	FINISH CODE / DOOR PRICE					
				#10	#20	#81	#99	#89	
PB401  PB401	<b>Substitute</b> DH41 Back to Back Push Bars	36"	DM010	\$42	\$49				Default Finish is #10 unless otherwise specified  Note: Hardware Finish #10 = Clear #20 = Bronze
		42"	DM011	\$51	\$65				
PH401  PH401	<b>Substitute</b> DH42 Back to Back Pull Handles	36"	DM013	\$0	\$0				
		42"	DM014	\$0	\$0				

# Impact Entrances



Adds, Substitutions, & Modifications

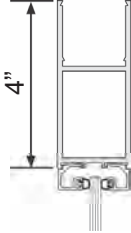

Note: Part Finish #11 = Clear & #21 Bronze

TOP RAIL								
ITEM	DESCRIPTION	LENGTH	P/N	FINISH CODE / DOOR PRICE				
				#11	#21	#81	#99	#89
	Substitute D102 for D101	36"	DM020	\$12	\$14	\$14	\$14	\$19
		42"	DM021	\$14	\$17	\$17	\$17	\$21
	Substitute D108 for D102	36"	DM023	\$14	\$19	\$19	\$19	\$26
		42"	DM024	\$17	\$21	\$21	\$21	\$28

Note: Part Finish #11 = Clear & #21 Bronze

BOTTOM RAIL								
ITEM	DESCRIPTION	LENGTH	P/N	FINISH CODE / DOOR PRICE				
				#11	#21	#81	#99	#89
	Substitute D108 for D102	36"	DM032	\$14	\$19	\$19	\$19	\$26
		42"	DM033	\$17	\$21	\$21	\$21	\$28
	Substitute D109 for D102	36"	DM035	\$19	\$23	\$23	\$23	\$30
		42"	DM036	\$21	\$26	\$26	\$26	\$33
	Substitute D109 for D108	36"	DM038	\$7	\$10	\$10	\$10	\$14
		42"	DM039	\$10	\$13	\$13	\$13	\$17

# Impact Entrances

Adds, Substitutions, & Modifications

Note: Part Finish #11 = Clear & #21 Bronze

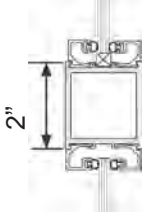
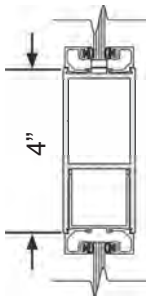
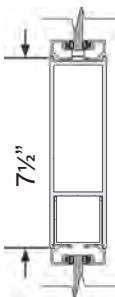
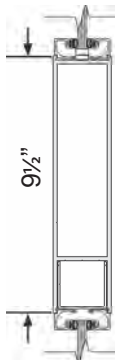
HORIZONTAL MUNTIN								
ITEM	DESCRIPTION	LENGTH	P/N	FINISH CODE / DOOR PRICE				
				#11	#21	#81	#99	#89
	Add 2" Horizontal Muntin	36"	DM053	\$185	\$189	\$189	\$189	\$198
		42"	DM054	\$189	\$198	\$198	\$198	\$205
	Add 4" Mid-Rail	36"	DM056	\$189	\$198	\$198	\$198	\$205
		42"	DM057	\$194	\$202	\$202	\$202	\$213
	Add 7-1/2" Mid-Rail	36"	DM060	\$209	\$213	\$213	\$213	\$233
		42"	DM061	\$220	\$229	\$229	\$229	\$251
	Add 9-1/2" Mid-Rail	36"	DM063	\$220	\$229	\$229	\$229	\$255
		42"	DM064	\$236	\$244	\$244	\$244	\$275

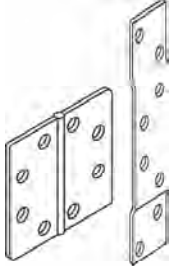
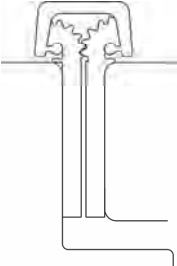

HINGE								
ITEM	DESCRIPTION	LENGTH	P/N	FINISH CODE / DOOR PRICE				
				#10	#20	#81	#99	#89
<b>DH110SS</b> 	<b>Add</b> DH110SS Butt Hinge (Stainless Steel), Includes back-up plates and screws	N/A	DM082	\$77	\$77	Default Finish is #10 unless otherwise specified  <b>Note: Hardware Finish</b> #10 = Clear #20 = Bronze		
<b>DH111HD</b> 	<b>Substitute</b> HD Continuous Gear Hinge for Butt Hinge	84"	DM090	\$182	\$238			
		96"	DM091	\$196	\$273			

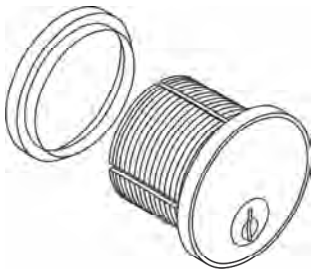
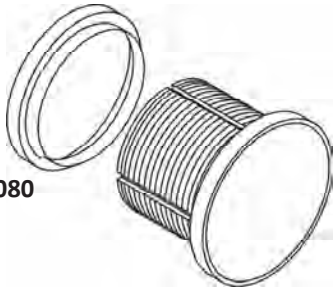
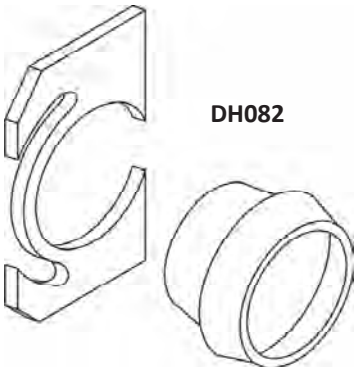
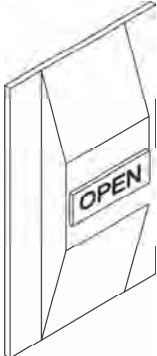

# Impact Entrances

Adds, Substitutions, & Modifications

CYLINDERS								
ITEM	DESCRIPTION	LENGTH	P/N	FINISH CODE / DOOR PRICE				
				#10	#20	#81	#99	#89
 <p><b>DH078</b></p>	<p><b>Substitute</b> DH078 Cylinder</p>	N/A	DM120	N/C	N/C			
 <p><b>DH080</b></p>	<p><b>Substitute</b> DH080 Dummy Cylinder</p>	N/A	DM121	N/C	N/C			
 <p><b>DH082</b></p>	<p><b>Add</b> DH082 Cylinder Guard</p>	N/A	DM122	\$14	\$14			
 <p><b>DH074</b></p>	<p><b>Add</b> DH074 Lock Indicator</p>	N/A	DM123	\$14	\$14			

Default Finish is #10  
unless otherwise  
specified

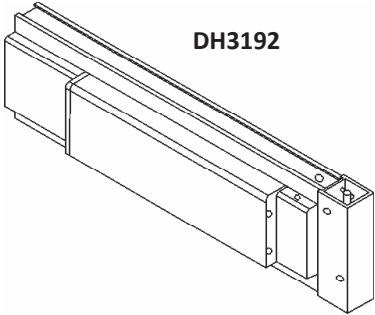
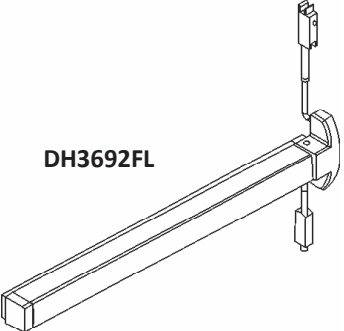
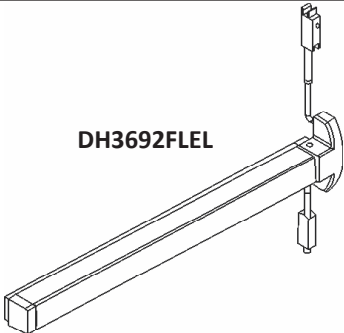
**Note: Hardware Finish**  
#10 = Clear  
#20 = Bronze

PANICS / EXIT DEVICES											
ITEM	DESCRIPTION	LENGTH	P/N	FINISH CODE / DOOR PRICE							
				#10	#20	#81	#99	#89			
 <p><b>DH3192</b></p>	<p><b>Add</b> First Choice 3192 Mid Panel Panic (Priced Per Leaf)</p>	36"	DM138	\$868	\$882	\$882	\$896	\$910			
		42"	DM139	\$896	\$910	\$910	\$924	\$938			
 <p><b>DH3692FL</b></p>	<p><b>Add</b> First Choice 3692FL Panic (Priced Per Leaf)</p>	36"	DM141	\$532	\$539	<p>Default Finish is #10 unless otherwise specified</p> <p><b>Note: Hardware Finish</b> #10 = Clear #20 = Bronze</p>					
		42"	DM142	\$539	\$546						
 <p><b>DH3692FLEL</b></p>	<p><b>Add</b> First Choice 3692FLEL Panic Motorized Electric (Priced Per Leaf)</p>	36"	DM147	\$2,114	\$2,114						
		42"	DM148	\$2,156	\$2,156						
 <p><b>DHC-EPT</b></p>	<p><b>Add</b> Securitron Electrical Power Transfer (Priced Per Leaf)</p>	N/A	DM180	\$259							

# Impact Entrances

Adds, Substitutions, & Modifications



Note: Part Finish #11 = Clear & #21 Bronze

DOOR WIDTH ADD								
ITEM	DESCRIPTION	STILE	P/N	FINISH CODE / DOOR PRICE				
				#11	#21	#81	#99	#89
	<b>ADD Pair Door Width &gt;72" up to 84"</b>	HR	DM207	\$238	\$252	\$252	\$266	\$280
		HS	DM208	\$252	\$266	\$266	\$280	\$294

Note: Part Finish #11 = Clear & #21 Bronze

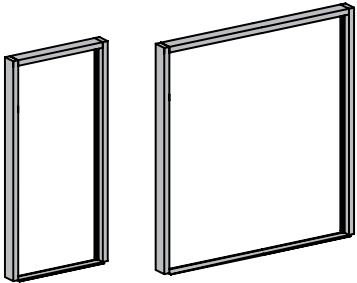
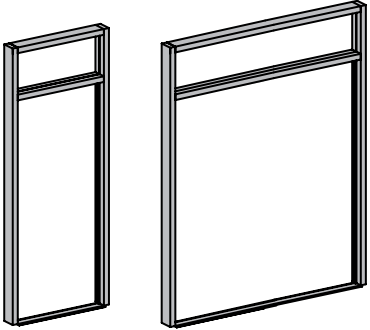
FRAME WIDTH ADD								
ITEM	DESCRIPTION	P/N	FINISH CODE / DOOR PRICE					
			#11	#21	#81	#99	#89	
	<b>Non Transom Pair Door Frame Door Opening Width &gt;72" Up To 84"</b>	DM221	\$35	\$42	\$42	\$49	\$56	
	<b>Transom Pair Door Frame Door Opening Width &gt;72" Up To 84"</b>	DM231	\$42	\$49	\$49	\$56	\$63	

**Section E**  
**IMPACT-RESISTANT STOREFRONTS**  
**Table of Contents**

FL500 Impact-Resistant Storefront System.....E1  
FL550 Impact-Resistant Storefront System.....E2  
FL550T Thermal Impact-Resistant Storefront  
System.....E3

Page Left Intentionally Blank

## Section E1 Table of Contents



2½" x 5"

	<i>Page</i>
High Velocity Hurricane Applications .....	1-2
Standard Framing Extrusions.....	3
Door Framing Extrusions .....	4
Accessories .....	5
Steel Reinforcing.....	6
Glazing Infill Charts and Setting Block/Setting Chair Charts .....	6

Page Left Intentionally Blank



## High Velocity Hurricane Zone Applications

Series FL500 Wet Glazed Hurricane Impact-Resistant Storefront System

### Qualified System Configuration Chart

Design Pressure P.S.F.	Intermediate Vertical Mullion	Wall Jamb Mullion	Maximum Mullion Span	Maximum Mullion Spacing CL to CL	Maximum Glass Size		Qualified Glass Types
					D.L.O. W x H	Sq. Ft.	
+60/-60	FL516/FL505 Heavy Duty Mullion	FL501	120"	48"	45½" x 96"	30.3	A-B
+65/-65	FL504/FL505	FL501	89"	48"	45½" x 84"	26.5	A-B
+70/-80	FL504/FL505 with SR504 Steel Reinforcement	FL501	120"	60"	57½" x 96"	38.3	A

#### Hurricane Impact-Resistant Products Disclaimer Note

Coral's hurricane impact-resistant products meet a variety of test standards for applications in coastal construction regions satisfying the demands for wind-borne debris hazards and high-velocity winds associated with hurricanes. All of Coral's hurricane impact-resistant products are independent laboratory tested based on a variety of test standards for air infiltration, water resistance, structural loads, missile impact and air-pressure cycling based ASTM and/or Florida Building Code. The informational chart above is intended to provide recommended limits in frame heights, glass sizes and design pressures based on product testing. When exceeding conditions listed above it is recommended to consult with licensed structural engineer or contact Coral Architectural Products.

### Qualified Glass Types

Glass Type	Glass Composition			Interlayer Manufacturer	Glass Identification
	Exterior Lite	Interlayer	Interior Lite		
⅝" Monolithic Glass	¼" Heat Strengthened Glass	.075 Vanceva Interlayer	¼" Heat Strengthened Glass	Solutia	A
⅝" Monolithic Glass	¼" Heat Strengthened Glass	.090 Saflex PVB Interlayer	¼" Heat Strengthened Glass	Solutia	B

#### Comparative Analysis of Glass Based on ASTM E-1300

Dade County Building Compliance Office allows comparative analysis of tested glass types provided the following five conditions are met:

1. Does not exceed maximum cyclic pressure tested.
2. Does not exceed maximum span of mullion tested.
3. Does not exceed maximum mullion spacing of mullion tested.
4. Does not exceed maximum square footage of largest lite tested.
5. Does not exceed aspect ratio of 5:1 (in a rectangular configuration, the ratio of the long-side to the short-side is defined as the aspect ratio).

## High Velocity Hurricane Zone Applications

Series FL500 Dry Glazed Hurricane Impact-Resistant Storefront System

**Qualified System Configuration Chart**

Design Pressure P.S.F.	Intermediate Vertical Mullion	Wall Jamb Mullion	Maximum Mullion Span	Maximum Mullion Spacing CL to CL	Maximum Glass Size		Qualified Glass Types
					D.L.O. W x H	Sq. Ft.	
+45/-45	FL516/FL505 Heavy Duty Mullion	FL501	120"	60"	57½" x 96"	38.3	D
+70/-70	FL504/FL505 with SR504 Steel Reinforcement	FL501	120"	60"	57½" x 96"	38.3	D

**Hurricane Impact-Resistant Products Disclaimer Note**

Coral’s hurricane impact-resistant products meet a variety of test standards for applications in coastal construction regions satisfying the demands for wind-borne debris hazards and high-velocity winds associated with hurricanes. All of Coral’s hurricane impact-resistant products are independent laboratory tested based on a variety of test standards for air infiltration, water resistance, structural loads, missile impact and air-pressure cycling based ASTM and/or Florida Building Code. The informational chart above is intended to provide recommended limits in frame heights, glass sizes and design pressures based on product testing. When exceeding conditions listed above it is recommended to consult with licensed structural engineer or contact Coral Architectural Products.







### Qualified Glass Types

Glass Type	Glass Composition			Interlayer Manufacturer	Glass Identification
	Exterior Lite	Interlayer	Interior Lite		
⅝" Monolithic Glass	¼" Heat Strengthened Glass	.090 Sentry Glas Interlayer (Dry-Glazed Application)	¼" Heat Strengthened Glass	Kuraray	D

**Comparative Analysis of Glass Based on ASTM E-1300**

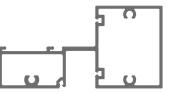
Florida Product Control Office allows comparative analysis of tested glass types provided the following five conditions are met:

1. Does not exceed maximum cyclic pressure tested.
2. Does not exceed maximum span of mullion tested.
3. Does not exceed maximum mullion spacing of mullion tested.
4. Does not exceed maximum square footage of largest lite tested.
5. Does not exceed aspect ratio of 5:1 (in a rectangular configuration, the ratio of the long-side to the short-side is defined as the aspect ratio).





STANDARD FRAMING EXTRUSIONS								
PART DESCRIPTION	PART NO.	PART LENGTH	PCS. PER BOX	FINISH CODE/STOCK LENGTH LIST PRICE				
				#10 CLEAR	#20 BRONZE	#81 WHITE	#2604 POWDER	#2605 POWDER
 <b>Head/Wall Jamb</b> (Deep Pocket)	<b>FL501</b>	24'	3	\$383	\$411	\$411	\$445	\$492
 <b>Sill/Optional Head</b> (Deep Pocket)	<b>FL502</b>	24'	4	\$322	\$348	\$348	\$368	\$404
 <b>Glass Stop</b>	<b>FL503</b>	24'	10	\$105	\$114	\$114	\$157	\$180
 <b>Intermediate Horizontal</b>	<b>FL506</b>	24'	4	\$357	\$373	\$373	\$473	\$523
 <b>Standard Vertical Mullion &amp; Door-frame Jamb</b>	<b>FL504</b>	24'	4	\$301	\$315	\$315	\$383	\$430
 <b>Heavy Wall Vertical Mullion</b>	<b>FL516</b>	24'	4	\$388	\$409	\$409	\$477	\$525
 <b>Pocket Filler</b> (For use with FL504 & FL516)	<b>FL505</b>	24'	5	\$184	\$199	\$199	\$214	\$237
 <b>Sub-Sill Flashing</b>	<b>FL519</b>	24'-3"	10	\$174	\$187	\$187	\$207	\$230

Note: Add Finish Code to the Part Number when ordering (Ex: **FL501-11** for Clear Anodized Finish)







# FL500·2½" x 5"







## Impact-Resistant Screw-Spline Storefront



DOOR FRAMING EXTRUSIONS								
PART DESCRIPTION	PART NO.	PART LENGTH	PCS. PER BOX	FINISH CODE/STOCK LENGTH LIST PRICE				
				#11 CLEAR	#21 BRONZE	#81 WHITE	#2604 POWDER	#2605 POWDER
 <b>Door Header/Transom Bar</b>	FL507	24'	2	\$448	\$467	\$467	\$605	\$667
 <b>Door Header/Transom Bar</b> (C.O.C.W./O.A., 2½ x 5)	FL562	24'	4	\$334	\$346	\$346	\$544	\$615
 <b>Flat Filler</b>	FL515	24'	10	\$117	\$126	\$126	\$180	\$209
 <b>Transom Sash</b>	FL517	24'	10	\$83	\$91	\$91	\$138	\$160
 <b>Transom Glass Stop</b>	FL518	24'	10	\$49	\$54	\$54	\$114	\$138

Note: Add Finish Code to the Part Number when ordering (Ex: FL501-11 for Clear Anodized Finish)

ACCESSORIES			
PART DESCRIPTION	PART NO.	QUANTITY	PRICE PER BOX
 <b>Spline Screw #14 x 1 HHSTS</b> (Assembly Screw)	AS16	100 (AS16-1)	\$17
 <b>#6 x 3/8" PPH Type AB</b> (Attaches End Dams)	AS31	100 (AS21-1)	\$8
 <b>Setting Chair</b> (Two Per Lite Required at Sill Member)	CS500-1	50 (CS500-2)	\$108
 <b>End Dam for Sill Flashing</b>	ED519-1	20 (ED519-2)	\$40
 <b>Exterior EPDM Gasket</b>	NG1	300 FT. (Per Roll)	\$163
 <b>1/4" Interior Spacer Gasket</b>	NG14	500 FT. (Per Roll)	\$245
 <b>Dry Glazed Gasket</b>	NG15	500 FT. (Per Roll)	\$398

ACCESSORIES			
PART DESCRIPTION	PART NO.	QUANTITY	PRICE PER BOX
 <b>4" Long EPDM Setting Block for 1/8" Glass</b> (Two Per Lite at Transom Sash)	SB11	50 (SB11-1)	\$42
 <b>4" Long EPDM Setting Block for 1/8" Glass</b> (Two Per Lite)	SB13	100 (SB13-1)	\$154
 <b>4" Long EPDM Setting Block for 1/8" Glass</b> (Two Per Lite at inverted horizontal)	SB20	100 (SB20-1)	\$48
 <b>Water Diverter</b> (Horizontal -Two Per Lite)	WD200-1	50 (WD200-2)	\$87
 <b>Joint Sealant Tape</b> (1/8" x 1/2" for Sealing Horizontal to Vertical Member Connections)	SM5601	30 FT. (Per Roll)	\$44
 <b>Caulking Stop</b> (Used at FL501 Head and Jambs)	FL515P-1	10	\$434

# FL500·2½" x 5

## Thermal Screw-Spline Storefront

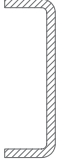
STEEL REINFORCING			
PART DESCRIPTION	PART NO.	QUANTITY	PRICE
 <p>1½" x 4½" x ¼" with Zinc Chromate Primer Steel Reinforcing</p>	SR504	10'-0"	\$409

GLAZING INFILL CHART					
SYSTEM	REGLET WIDTH	GLAZING TECHNIQUE	INFILL THICKNESS	GASKET COMBINATIONS	
FL500	9/16"	Wet Glazed	9/16"	NG14 (DOW995)	NG1
		Dry Glazed	9/16"	NG15 (DOW995)	NG1

SETTING BLOCK AND SETTING CHAIR CHART					
GLASS SIZE	PART DESCRIPTION	PART NO.	GLAZING APPLICATION	SETTING BLOCK PART NO.	SETTING CHAIR PART NO.
9/16"	Sill Member	FL502	Exterior Glazed	SB13	CS500-1
9/16"	Intermediate Horizontal	FL506	Exterior Glazed	SB13	Not Required
		FL506	Interior Glazed	SB20	Not Required

## Section E2 Table of Contents



2½" x 5"

	<i>Page</i>
High Velocity Hurricane Applications .....	1-2
Standard Framing Extrusions.....	3
Door Framing Extrusions .....	4
Accessories .....	5
Glazing Infill Charts and Setting Block/Setting Chair Charts .....	6

Page Left Intentionally Blank



## High Velocity Hurricane Zone Applications

Series FL550 Wet Glazed Hurricane Impact-Resistant Storefront System

### Qualified System Configuration Chart

Design Pressure P.S.F.	Intermediate Vertical Mullion	Wall Jamb Mullion	Maximum Mullion Span	Maximum Mullion Spacing CL to CL	Maximum Glass Size		Qualified Glass Types
					D.L.O. W x H	Sq. Ft.	
+60/-60	FL566/FL555 Heavy Duty Mullion	FL551	120"	48"	45½" x 96"	30.3	IA-IB
+65/-65	FL554/FL555	FL551	89"	48"	45½" x 84"	26.5	IA-IB
+70/-80	FL554/FL555 with SR504 Steel Reinforcement	FL551	120"	60"	57½" x 96"	38.3	1A

#### Hurricane Impact-Resistant Products Disclaimer Note

Coral's hurricane impact-resistant products meet a variety of test standards for applications in coastal construction regions satisfying the demands for wind-borne debris hazards and high-velocity winds associated with hurricanes. All of Coral's hurricane impact-resistant products are independent laboratory tested based on a variety of test standards for air infiltration, water resistance, structural loads, missile impact and air-pressure cycling based ASTM and/or Florida Building Code. The informational chart above is intended to provide recommended limits in frame heights, glass sizes and design pressures based on product testing. When exceeding conditions listed above it is recommended to consult with licensed structural engineer or contact Coral Architectural Products.

### Qualified Glass Types

Glass Type	Glass Composition			Interlayer Manufacturer	Glass Identification
	Exterior Lite	Air Space/ Spacer Type	Interior Lite		
1½" Insulated Glass	¼" Heat Strengthened Glass	½" Air Space with Aluminum Box Spacer	¼" Heat Strengthened Glass .075 Vanceva Interlayer ¼" Heat Strengthened Glass	Solutia	IA
1½" Insulated Glass	¼" Heat Strengthened Glass	½" Air Space with Aluminum Box Spacer	¼" Heat Strengthened Glass .090 Saflex Interlayer ¼" Heat Strengthened Glass	Solutia	IB

#### Comparative Analysis of Glass Based on ASTM E-1300

Dade County Building Compliance Office allows comparative analysis of tested glass types provided the following five conditions are met:

1. Does not exceed maximum cyclic pressure tested.
2. Does not exceed maximum span of mullion tested.
3. Does not exceed maximum mullion spacing of mullion tested.
4. Does not exceed maximum square footage of largest lite tested.
5. Does not exceed aspect ratio of 5:1 (in a rectangular configuration, the ratio of the long-side to the short-side is defined as the aspect ratio).

## High Velocity Hurricane Zone Applications

Series FL550 Dry Glazed Hurricane Impact-Resistant Storefront System

### Qualified System Configuration Chart

Design Pressure P.S.F.	Intermediate Vertical Mullion	Wall Jamb Mullion	Maximum Mullion Span	Maximum Mullion Spacing CL to CL	Maximum Glass Size		Qualified Glass Types
					D.L.O. W x H	Sq. Ft.	
+45/-45	FL566/FL555 Heavy Duty Mullion	FL551	120"	60"	57½" x 96"	38.3	ID
+70/-70	FL554/FL555 with SR504 Steel Reinforcement	FL551	120"	60"	57½" x 96"	38.3	ID

#### Hurricane Impact-Resistant Products Disclaimer Note

Coral's hurricane impact-resistant products meet a variety of test standards for applications in coastal construction regions satisfying the demands for wind-borne debris hazards and high-velocity winds associated with hurricanes. All of Coral's hurricane impact-resistant products are independent laboratory tested based on a variety of test standards for air infiltration, water resistance, structural loads, missile impact and air-pressure cycling based ASTM and/or Florida Building Code. The informational chart above is intended to provide recommended limits in frame heights, glass sizes and design pressures based on product testing. When exceeding conditions listed above it is recommended to consult with licensed structural engineer or contact Coral Architectural Products.









### Qualified Glass Types

Glass Type	Glass Composition			Interlayer Manufacturer	Glass Identification
	Exterior Lite	Air Space/ Spacer Type	Interior Lite		
1⅝" Laminated Glass	¼" Heat Strengthened Glass or Tempered	½" Air Space with Aluminum Box Spacer	¼" Heat Strengthened Glass .090 Sentry Glass Interlayer ¼" Heat Strengthened Glass	DuPont™	ID

#### Comparative Analysis of Glass Based on ASTM E-1300

Florida Product Control Office allows comparative analysis of tested glass types provided the following five conditions are met:







1. Does not exceed maximum cyclic pressure tested.
2. Does not exceed maximum span of mullion tested.
3. Does not exceed maximum mullion spacing of mullion tested.
4. Does not exceed maximum square footage of largest lite tested.
5. Does not exceed aspect ratio of 5:1 (in a rectangular configuration, the ratio of the long-side to the short-side is defined as the aspect ratio).

STANDARD FRAMING EXTRUSIONS								
PART DESCRIPTION	PART NO.	PART LENGTH	PCS. PER BOX	FINISH CODE/STOCK LENGTH LIST PRICE				
				#11 CLEAR	#21 BRONZE	#81 WHITE	#2604 POWDER	#2605 POWDER
 <b>Head/Wall Jamb</b> (Deep Pocket)	FL551	24'	4	\$383	\$411	\$411	\$433	\$478
 <b>Sill/Optional Head</b> (Deep Pocket)	FL552	24'	4	\$328	\$353	\$353	\$368	\$392
 <b>Glass Stop</b>	FL553	24'	10	\$98	\$107	\$107	\$151	\$174
 <b>Intermediate Horizontal</b>	FL556	24'	4	\$349	\$366	\$366	\$448	\$493
 <b>Standard Vertical Mullion &amp; Door-frame Jamb</b>	FL554	24'	4	\$301	\$315	\$315	\$372	\$415
 <b>Heavy Wall Vertical Mullion</b>	FL566	24'	4	\$388	\$409	\$409	\$466	\$511
 <b>Pocket Filler</b> (For use with FL554 & FL566)	FL555	24'	5	\$182	\$198	\$198	\$211	\$236
 <b>Sub-Sill</b>	FL519	24'	10	\$174	\$187	\$187	\$207	\$230
 <b>High Performance Sub-Sill</b>	FL539	24'	10	\$276	\$290	\$290	\$381	\$426















Note: Add Finish Code to the Part Number when ordering (Ex: FL551-11 for Clear Anodized Finish)

# FL550·2½" x 5"

## Impact-Resistant Screw-Spline Storefront

DOOR FRAMING EXTRUSIONS								
PART DESCRIPTION	PART NO.	PART LENGTH	PCS. PER BOX	FINISH CODE/STOCK LENGTH LIST PRICE				
				#11 CLEAR	#21 BRONZE	#81 WHITE	#2604 POWDER	#2605 POWDER
 <b>Door Header/Transom Bar</b>	FL507	24'	2	\$448	\$467	\$467	\$605	\$607
 <b>Door Header/Transom Bar</b> (C.O.C.W./O.A., 2½ x 5)	FL562	24'	4	\$334	\$346	\$346	\$544	\$615
 <b>Flat Filler</b>	FL515	24'	10	\$117	\$126	\$126	\$180	\$209
 <b>Transom Sash</b> ( $\frac{1}{16}$ " Infill)	FL517	24'	10	\$83	\$91	\$91	\$138	\$160
 <b>Transom Glass Stop</b>	FL518	24'	10	\$49	\$54	\$54	\$114	\$138
 <b>Transom Sash</b> (1- $\frac{3}{16}$ " Infill)	FL567	24'	10	\$91	\$100	\$100	\$144	\$166

Note: Add Finish Code to the Part Number when ordering (Ex: FL501-11 for Clear Anodized Finish)

ACCESSORIES				ACCESSORIES			
PART DESCRIPTION	PART NO.	PART LENGTH	PRICE PER BOX	PART DESCRIPTION	PART NO.	PART LENGTH	PRICE PER BOX
 <b>Spline Screw #14 x 1 HHSTS</b> (Assembly Screw)	<b>AS16</b>	100 (AS16-1)	\$17	 <b>4" Long EPDM Setting Block for 1<sup>1</sup>/<sub>16</sub>" Glass</b> (Two Per Lite at transom sash)	<b>SB7</b>	100 (SB7-1)	\$103
 <b>#6 x 3/8" PPH Type AB</b> (Attaches End Dams)	<b>AS31</b>	100 (AS21-1)	\$8	 <b>4" Long EPDM Setting Block for 1<sup>1</sup>/<sub>16</sub>" Glass</b> (Two Per Lite at horizontal and sill)	<b>SB15</b>	100 (SB15-1)	\$178
 <b>Setting Chair</b> (Two Per Lite Required at Sill Member)	<b>CS500-1</b>	50 (CS500-2)	\$108	 <b>4" Long EPDM Setting Block for 1<sup>1</sup>/<sub>16</sub>" Glass</b> (Two Per Lite at inverted horizontal)	<b>SB16</b>	100 (SB16-1)	\$154
 <b>End Dam for Sill Flashing</b>	<b>ED519-1</b>	20 (ED519-2)	\$40	 <b>Water Diverter</b> (Horizontal - Two Per Lite)	<b>WD300-1</b>	50 (WD300-2)	\$74
 <b>Exterior EPDM Gasket</b>	<b>NG1</b>	300 FT. (Per Roll)	\$163	 <b>Joint Sealant Tape</b> (3/8" x 1/2" for Sealing Horizontal to Vertical Member Connections)	<b>SM5601</b>	30 FT. (Per Roll)	\$44
 <b>EPDM Gasket for DS550 Door stop at Doorjamb</b>	<b>NG5</b>	500 FT. (Per Roll)	\$330	 <b>Caulking Stop</b> (Used at FL551 Head and Jambs)	<b>FL515P-1</b>	10	\$434
 <b>1/4" Interior Spacer Gasket</b>	<b>NG14</b>	500 FT. (Per Roll)	\$245				
 <b>Dry Glazed Gasket</b>	<b>NG15</b>	500 FT. (Per Roll)	\$398				

# FL550·2½" x 5"

## Impact-Resistant Screw-Spline Storefront

STEEL REINFORCING			
PART DESCRIPTION	PART NO.	QUANTITY LENGTH	PRICE
 <b>1½" x 4⅝" x ¼" with Zinc Chromate Primer Steel Reinforcing</b>	SR504	x1	\$409
		10'-0"	

GLAZING INFILL CHART					
SYSTEM	REGLET WIDTH	GLAZING TECHNIQUE	INFILL THICKNESS	GASKET COMBINATIONS	
FL550	1½"	Wet Glazed	1⅝"	NG14 (DOW995)	NG1
		Dry Glazed	1⅝"	NG15	NG1

SETTING BLOCK AND SETTING CHAIR CHART					
GLASS SIZE	PART DESCRIPTION	PART NO.	GLAZING APPLICATION	SETTING BLOCK PART NO.	SETTING CHAIR PART NO.
1⅝"	Sill Member	FL552	Exterior Glazed	SB15	CS500-1
1⅝"	Intermediate Horizontal	FL556	Exterior Glazed	SB15	Not Required
		FL556	Interior Glazed	SB16	Not Required

## Section E3 Table of Contents



2½" x 5"

	<i>Page</i>
High Velocity Hurricane Applications .....	1
Standard Framing Extrusions.....	2
Accessories .....	3
Glazing Infill Charts and Setting Block/Setting Chair Charts .....	4

Page Left Intentionally Blank



## High Velocity Hurricane Zone Applications

Series FL550T Thermal Dry Glazed Hurricane Impact-Resistant Storefront System

### Qualified System Configuration Chart

Design Pressure P.S.F.	Intermediate Vertical Mullion	Wall Jamb Mullion	Maximum Mullion Span	Maximum Mullion Spacing CL to CL	Maximum Glass Size		Qualified Glass Types
					D.L.O. W x H	Sq. Ft.	
+55/-55 Large Missile	FL574T/FL575T Heavy Duty Mullion	FL571T	120"	48"	45½" x 84"	27.19	IB, ID
+55/-55 Large Missile	FL574T/FL575T Heavy Duty Mullion	FL571T	120"	48"	45½" x 96"	30.3	ID
+60/-60 Small Missile	FL574T/FL575T Heavy Duty Mullion	FL571T	108"	48"	45½" x 103"	32.5	ID

#### Hurricane Impact-Resistant Products Disclaimer Note

Coral's hurricane impact-resistant products meet a variety of test standards for applications in coastal construction regions satisfying the demands for wind-borne debris hazards and high-velocity winds associated with hurricanes. All of Coral's hurricane impact-resistant products are independent laboratory tested based on a variety of test standards for air infiltration, water resistance, structural loads, missile impact and air-pressure cycling based ASTM and/or Florida Building Code. The informational chart above is intended to provide recommended limits in frame heights, glass sizes and design pressures based on product testing. When exceeding conditions listed above it is recommended to consult with licensed structural engineer or contact Coral Architectural Products.

### Qualified Glass Types

Glass Type	Glass Composition			Interlayer Manufacturer	Glass Identification
	Exterior Lite	Air Space/ Spacer Type	Interior Lite (Laminated Glass)		
1⅝" Insulated Glass	¼" Heat Strengthened or Tempered Glass	½" Air Space with Aluminum Box Spacer	¼" Heat Strengthened Glass .090 DVB ¼" HeatStrengthened Glass (Wet Glazed)	Kuraray	IB
1⅝" Insulated Glass	¼" Heat Strengthened or Tempered Glass	½" Air Space with Aluminum Box Spacer	¼" Heat Strengthened Glass .090 Sentry Glass Interlayer ¼" HeatStrengthened Glass (Dry Glazed)	Kuraray	ID
1⅝" Insulated Glass	¼" Heat Strengthened or Tempered Glass	½" Air Space with Aluminum Box Spacer	¼" Heat Strengthened Glass .035 Sentry Glass Interlayer ¼" HeatStrengthened Glass (Small Missile Application Only)	Kuraray	IC

#### Comparative Analysis of Glass Based on ASTM E-1300







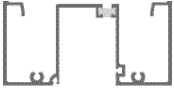
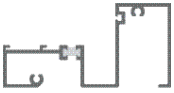

Florida Product Control Office allows comparative analysis of tested glass types provided the following five conditions are met:

1. Does not exceed maximum cyclic pressure tested.
2. Does not exceed maximum span of mullion tested.
3. Does not exceed maximum mullion spacing of mullion tested.
4. Does not exceed maximum square footage of largest lite tested.
5. Does not exceed aspect ratio of 5:1 (in a rectangular configuration, the ratio of the long-side to the short-side is defined as the aspect ratio).

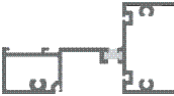

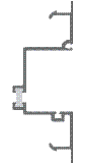











# FL550T·2½" x 5"

Thermal Impact-Resistant Storefront



STANDARD FRAMING EXTRUSIONS									
PART DESCRIPTION	PART NO.	PART LENGTH	PCS. PER BOX	FINISH CODE/STOCK LENGTH LIST PRICE					
				#11 CLEAR	#21 BRONZE	#83 WHITE	#2604 POWDER	#2605 POWDER	
 <b>Head/Wall Jamb</b> (Deep Pocket)	FL571T	24'-3"	4	\$440	\$471	\$471	\$485	\$530	
 <b>Sill/Optional Head</b> (Deep Pocket)	FL572T	24'-3"	4	\$395	\$422	\$422	\$432	\$450	
 <b>Glass Stop</b>	FL553	24'-3"	10	\$98	\$107	\$107	\$151	\$174	
 <b>Intermediate Horizontal</b>	FL576T	24'-3"	4	\$423	\$440	\$440	\$519	\$565	
 <b>Heavy Wall Vertical Mullion &amp; Door-frame Jamb</b>	FL574T	24'-3"	4	\$443	\$467	\$467	\$516	\$562	
 <b>Pocket Filler</b> (For use with FL574T)	FL575T	24'-3"	5	\$231	\$248	\$248	\$265	\$289	
 <b>High Performance Subsill</b>	FL539T	24'-3"	10	\$299	\$313	\$313	\$404	\$449	
 <b>Transom Sash</b>	FL567	24'-3"	10	\$91	\$100	\$100	\$144	\$166	
 <b>Transom Glass Stop</b>	FL518	24'-3"	10	\$49	\$54	\$54	\$114	\$138	

Note: Add Finish Code to the Part Number when ordering (Ex: **FL571T-11** for Clear Anodized Finish)

ACCESSORIES				ACCESSORIES			
PART DESCRIPTION	PART NO.	PART LENGTH	PRICE PER BOX	PART DESCRIPTION	PART NO.	PART LENGTH	PRICE PER BOX
 <b>Spline Screw</b> #14 x 1 HHSTS (Assembly Screw)	AS16	100 (AS16-1)	\$17	 <b>4" Long EPDM Setting Block</b> for 1½" Glass (Two Per Lite at inverted horizontal)	SB15	100 (SB15-1)	\$178
 <b>#6 x ¾" PPH Type AB</b> (Attaches End Dams)	AS31	100 (AS21-1)	\$8	 <b>SB17-1 Setting Block</b> for Intermediate Horizontal FL550T Dry Glazed Inside Glaze	SB17	100 (SB17-1)	\$143
 <b>Setting Chair</b> (Two Per Lite Required at Sill Member)	CS500-1	50 (CS500-2)	\$108	 <b>SB25-1 Setting Block Chair</b> for Sill (FL571T) FL550T Dry Glazed Inside Glaze	SB25	25 (SB25-1)	\$73
 <b>End Dam for Sill Flashing</b>	ED519-1	20 (ED519-2)	\$40	 <b>Water Diverter</b> (Horizontal -Two Per Lite)	WD300-1	50 (WD300-2)	\$74
 <b>Exterior EPDM Gasket</b>	NG1	300 FT. (Per Roll)	\$163	 <b>Joint Sealant Tape</b> (½" x ½" for Sealing Horizontal to Vertical Member Connections)	SM5601	30 FT. (Per Roll)	\$44
 <b>EPDM Gasket for DS550 Door stop at Doorjamb</b>	NG5	500 FT. (Per Roll)	\$330	 <b>Caulking Stop</b> (Used at FL571T Head and Jamb)	FL575P-1	10	\$405
 <b>¼" Interior Spacer Gasket</b>	NG14	500 FT. (Per Roll)	\$245				
 <b>Dry Glazed Gasket</b>	NG15	500 FT. (Per Roll)	\$398				

# FL550T·2½" x 5"

Thermal Impact-Resistant Storefront



GLAZING INFILL CHART					
SYSTEM	REGLET WIDTH	GLAZING TECHNIQUE	INFILL THICKNESS	GASKET COMBINATIONS	
FL550	1⅝"	Wet Glazed	1⅝"	NG14 (DOW995)	NG1
		Dry Glazed	1⅝"	NG15	NG1

SETTING BLOCK AND SETTING CHAIR CHART					
GLASS SIZE	PART DESCRIPTION	PART NO.	GLAZING APPLICATION	SETTING BLOCK PART NO.	SETTING CHAIR PART NO.
1⅝"	Sill Member	FL552	Exterior Glazed	SB15	CS500-1
1⅝"	Intermediate Horizontal	FL556	Exterior Glazed	SB15	Not Required
		FL556	Interior Glazed	SB16	Not Required

**Section F**  
**IMPACT-RESISTANT CURTAIN WALLS**  
**Table of Contents**

PW256 Impact-Resistant Curtain Wall..... F1  
PW257 Impact-Resistant Curtain Wall..... F2

Page Left Intentionally Blank

Section F1  
 Table of Contents









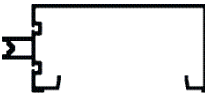

2½" x 6<sup>9</sup>/<sub>16</sub>"

for 9/16" Laminated Glass

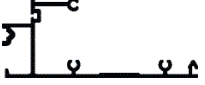
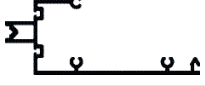
	<i>Page</i>
Standard Framing Extrusions.....	1
Corner Framing Extrusions .....	2
Optional Framing Extrusions .....	3
Door Framing Extrusions .....	3
Accessories.....	4
Steel Reinforcing.....	5
Glazing Infill Charts and Setting Block/Setting Chair Charts .....	5

Page Left Intentionally Blank









STANDARD FRAMING EXTRUSIONS									
PART DESCRIPTION	PART NO.	PART LENGTH	PCS. PER BOX	FINISH CODE/STOCK LENGTH LIST PRICE					
				#11 CLEAR	#21 BRONZE	#81 WHITE	#2604 POWDER	#2605 POWDER	
 9/16" Glazing Vertical Jamb Mullion	PW550	24'	3	\$355	\$378	\$378	\$398	\$439	
 Butt Glaze Vertical Mullion	PW151	24'	3	\$307	\$328	\$328	\$359	\$399	
 9/16" Glazing Head / Sill	PW552	24'	3	Mill-00	N/A	N/A	N/A	N/A	
				\$259					
 9/16" Glazing Intermediate Horizontal	PW555	24'	3	\$345	\$369	\$369	\$391	\$415	
 Vertical Mullion Filler	PW202	24'	12	\$128	\$138	\$138	\$173	\$201	
 Head / Horizontal / Sill Trim	PW203	24'	4	\$187	\$202	\$202	\$173	\$201	
 Pre-punched Pressure Bar w / spacer gasket	PW204-1	24'	12	Mill-00	N/A	N/A	N/A	N/A	
				\$108					
 Vertical/Horizontal Face Cover	PW205	24'	12	\$59	\$66	\$66	\$109	\$129	
 ¼" Transition Glazing Adapter for Butt - Glazed Mullion	PW513	24'	12	\$48	\$55	\$55	\$114	\$136	

Note: Add Finish Code to the Part Number when ordering (Ex: **PW550-11** for Clear Anodized Finish)





# PW256·2½" x 6<sup>9</sup>/<sub>16</sub>"

## Screw-Spline Curtain Wall



CORNER FRAMING EXTRUSIONS									
PART DESCRIPTION	PART NO.	PART LENGTH	PCS. PER BOX	FINISH CODE/STOCK LENGTH LIST PRICE					
				#11 CLEAR	#21 BRONZE	#81 WHITE	#2604 POWDER	#2605 POWDER	
 9/16" Glazing Tee 90° O.S. Corner	PW556	24'	4	Mill-00	N/A	N/A	N/A	N/A	
				\$140					
 90° O.S. Corner Prepunched Pressure Bar W/Spacer Gasket	PW154	24'	4	Mill-00	N/A	N/A	N/A	N/A	
				\$217					
 1" Glazing face cover 90° O.S. Corner (2 REQ'D)	PW158	24'	12	\$84	\$93	\$93	\$150	\$175	
 Female Half 90° O.S. Corner	PW208	24'	4	\$218	\$251	\$251	\$296	\$331	
 Male Half 90° O.S. Corner	PW209	24'	4	\$248	\$265	\$265	\$305	\$341	
 Interior 90° Corner Trim	PW210	24'	4	\$124	\$133	\$133	\$194	\$226	
 90° Corner Splice	PW211	24'	4	Mill-00	N/A	N/A	N/A	N/A	
				\$166					

Note: Add Finish Code to the Part Number when ordering (Ex: **PW550-11** for Clear Anodized Finish)

DOOR FRAMING EXTRUSIONS								
PART DESCRIPTION	PART NO.	PART LENGTH	PCS. PER BOX	FINISH CODE/STOCK LENGTH LIST PRICE				
				#11 CLEAR	#21 BRONZE	#81 WHITE	#2604 POWDER	#2605 POWDER
 Header / Transom Bar for Surface Mount Closer	FL207	24'	4	\$318	\$334	\$334	\$455	\$509
 Frame Jamb	PW214	24'	4	\$192	\$209	\$209	\$298	\$339
 COC Transom Bar / Header	FL212	24'	4	\$248	\$258	\$258	\$429	\$489
 Snap-in Door Stop (Use with FL207)	DS200	24'	3	\$44	\$48	\$48	\$89	\$110
 Screw Applied Door Stop (Use with FL212)	DS202	24'	4	\$110	\$118	\$118	\$190	\$224

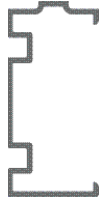





OPTIONAL FRAMING EXTRUSIONS								
PART DESCRIPTION	PART NO.	PART LENGTH	PCS. PER BOX	FINISH CODE/STOCK LENGTH LIST PRICE				
				#11 CLEAR	#21 BRONZE	#81 WHITE	#2604 POWDER	#2605 POWDER
 Splice Sleeve / or Mullion Reinforcement	PW207	24'	3	Mill-00	N/A	N/A	N/A	N/A
				\$265				



Note: Add Finish Code to the Part Number when ordering (Ex: PW550-11 for Clear Anodized Finish)

# PW256·2½" x 6⅞"

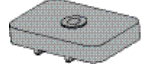
## Screw-Spline Curtain Wall

ACCESSORIES			
PART DESCRIPTION	PART NO.	QTY	PRICE PER BOX
 <b>Spline Screw #14 x 1 HHSTS</b>	AS16	100 (AS16-1)	\$17
 <b>Pressure Bar Screws</b>	AS19	200 (AS16-1)	\$30
 <b>#8 x 1/2" PPH B P+C</b>	AS2	100 (AS2-1)	\$19
 <b>#12 x ¾" HWH #3 Zinc Plated Self Drilling</b>	AS25	100 (AS25-1)	\$12
 <b>#14 x 1" FHP Self Drilling</b>	AS35	100 (AS35-1)	\$20
 <b>3 x 1/4 x 20 Hex Head Bolt SS</b>	AS53	25 (AS53-1)	\$30
 <b>1/4 Flat Washer SS</b>	AS54	50 (AS54-1)	\$12
 <b>1/4 x 20 Lock Nut SS</b>	AS55	25 (AS55-1)	\$13
 <b>Interior / Exterior Glazing Gasket at Glass</b>	NG10	250 FT. (Per Roll)	\$155
 <b>Exterior Perimeter Gasket</b>	NG11	500 FT. (Per Roll)	\$313
 <b>Butt Glaze Spacer Gasket</b>	NG14	500 FT. (Per Roll)	\$245

ACCESSORIES			
PART DESCRIPTION	PART NO.	QTY	PRICE PER BOX
 <b>Dry Glaze Gasket</b>	NG16	500 FT.	\$668
 <b>4" Long EPDM Setting Block for 1" Glass</b>	SB14	100 (SB14-1)	\$95
 <b>End Dam</b>	SP202	50 (SP202-1)	\$68
 <b>Butt Glaze Mullion Bridge for 1" Glazing</b>	SP206	50 (SP206-1)	\$74
 <b>Top and Bottom Mullion Cover</b>	SP210	50	\$74
 <b>Temporary Glazing Retainer</b>	SP253	50 (SP253-1)	\$62
 <b>Joint Sealant Tape</b> (½" x ½" for Sealing Horizontal to Vertical Member Connections)	SM5601	30 FT. (Per Roll)	\$44

STEEL REINFORCING			
PART DESCRIPTION	PART NO.	QTY	PRICE
 <b>1<sup>7</sup>/<sub>8</sub>" x 4<sup>1</sup>/<sub>2</sub>" x ¼"</b> <b>with Zinc Chromate            Primer Steel Reinforcing</b>	SR150	1	\$461
		12'-0"	
 <b>1<sup>7</sup>/<sub>8</sub>" x 4<sup>1</sup>/<sub>2</sub>" x 10 Ga.</b> <b>Steel Reinforcing</b>	SR151	1	\$415
		14'-0"	
 <b>1<sup>7</sup>/<sub>16</sub>" x 4<sup>5</sup>/<sub>8</sub>" x ¼"</b> <b>with Zinc Chromate            Primer Steel Reinforcing</b>	SR504	1	\$409
		10'-0"	

Page Left Intentionally Blank

Section F2  
 Table of Contents

**PW257**   
**Hurricane Impact-Resistant Curtain Wall**







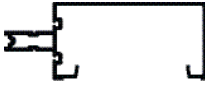

2½" x 7<sup>5</sup>/<sub>16</sub>"

for 1<sup>5</sup>/<sub>16</sub>" Laminated / Insulated Glass

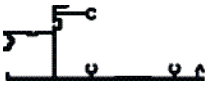
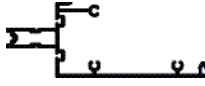
	<i>Page</i>
Standard Framing Extrusions.....	1
Corner Framing Extrusions .....	2
Optional Framing Extrusions .....	3
Door Framing Extrusions .....	3
Accessories.....	4
Steel Reinforcing.....	5
Glazing Infill Charts and Setting Block/Setting Chair Charts .....	5

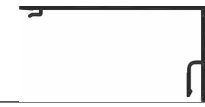
Page Left Intentionally Blank









STANDARD FRAMING EXTRUSIONS								
PART DESCRIPTION	PART NO.	PART LENGTH	PCS. PER BOX	FINISH CODE/STOCK LENGTH LIST PRICE				
				#11 CLEAR	#21 BRONZE	#81 WHITE	#2604 POWDER	#2605 POWDER
 1-5/16" Glazing Vertical Jamb Mullion	PW650	24'	3	\$401	\$427	\$427	\$506	\$574
 Butt Glaze Vertical Mullion	PW151	24'	3	\$307	\$328	\$328	\$359	\$399
 1-5/16" Glazing Head Sill	PW652	24'	3	Mill-00	N/A	N/A	N/A	N/A
				\$304				
 1-5/16" Glazing Intermediate Horizontal	PW655	24'	3	\$392	\$416	\$416	\$462	\$516
 Vertical Mullion Filler	PW202	24'	12	\$128	\$138	\$138	\$173	\$201
 Head / Horizontal / Sill Trim	PW203	24'	4	\$187	\$202	\$202	\$249	\$287
 Pre-punched Pressure Bar w / spacer gasket	PW204-1	24'	12	Mill-00	N/A	N/A	N/A	N/A
				\$108				
 Vertical/Horizontal Face Cover	PW205	24'	12	\$59	\$66	\$66	\$109	\$129
 ¼" Transition Glazing Adapter for Butt - Glazed Mullion	PW613	24'	12	\$68	\$72	\$72	\$118	\$140

Note: Add Finish Code to the Part Number when ordering (Ex: **PW650-11** for Clear Anodized Finish)





# PW257·2½" x 7<sup>5</sup>/<sub>16</sub>"

## Screw-Spline Curtain Wall



CORNER FRAMING EXTRUSIONS									
PART DESCRIPTION	PART NO.	PART LENGTH	PCS. PER BOX	FINISH CODE/STOCK LENGTH LIST PRICE					
				#11 CLEAR	#21 BRONZE	#81 WHITE	#2604 POWDER	#2605 POWDER	
 1-5/16" Glazing Tee 90° O.S. Corner	PW656	24'	4	Mill-00	N/A	N/A	N/A	N/A	
				\$173					
 90° O.S. Corner Prepunched Pressure Bar W/Spacer Gasket	PW654	24'	4	Mill-00	N/A	N/A	N/A	N/A	
				\$175					
 1-5/16" Glazing face cover 90° O.S. Corner (2 REQ'D)	PW658	24'	12	\$90	\$98	\$98	\$157	\$185	
 Female Half 90° O.S. Corner	PW208	24'	4	\$234	\$251	\$251	\$296	\$331	
 Male Half 90° O.S. Corner	PW209	24'	4	\$248	\$265	\$265	\$305	\$341	
 Interior 90° Corner Trim	PW210	24'	4	\$124	\$133	\$133	\$194	\$226	
 90° Corner Splice	PW211	24'	4	Mill-00	N/A	N/A	N/A	N/A	
				\$166					

Note: Add Finish Code to the Part Number when ordering (Ex: **PW650-11** for Clear Anodized Finish)



DOOR FRAMING EXTRUSIONS								
PART DESCRIPTION	PART NO.	PART LENGTH	PCS. PER BOX	FINISH CODE/STOCK LENGTH LIST PRICE				
				#11 CLEAR	#21 BRONZE	#81 WHITE	#2604 POWDER	#2605 POWDER
 Header / Transom Bar for Surface Mount Closer	FL207	24'	4	\$318	\$334	\$334	\$455	\$509
 Frame Jamb	PW214	24'	4	\$192	\$209	\$209	\$256	\$292
 COC Transom Bar / Header	FL212	24'	4	\$248	\$258	\$258	\$429	\$489
 Snap-in Door Stop (Use with FL207)	DS200	24'	3	\$44	\$48	\$48	\$89	\$110
 Screw Applied Door Stop (Use with FL212)	DS202	24'	4	\$110	\$118	\$118	\$190	\$224







OPTIONAL FRAMING EXTRUSIONS								
PART DESCRIPTION	PART NO.	PART LENGTH	PCS. PER BOX	FINISH CODE/STOCK LENGTH LIST PRICE				
				#11 CLEAR	#21 BRONZE	#81 WHITE	#2604 POWDER	#2605 POWDER
 Splice Sleeve / or Mullion Reinforcement	PW207	24'	3	Mill-00	N/A	N/A	N/A	N/A
				\$265				

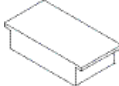

Note: Add Finish Code to the Part Number when ordering (Ex: PW650-10 for Clear Anodized Finish)

# PW257·2½" x 7<sup>5</sup>/<sub>16</sub>"

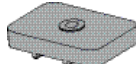
## Screw-Spline Curtain Wall

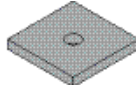
ACCESSORIES			
PART DESCRIPTION	PART NO.	QTY	PRICE PER BOX
 Spline Screw #14 x 1 HHSTS	AS16	100 (AS16-1)	\$17
 #8 x 1/2" PPH	AS2	100 (AS2-1)	\$19
 #12 x ¾" #3 Zinc Plated Self Drilling	AS25	100 (AS25-1)	\$12
 12 x 1¼" #3 Zinc Plated Self Drilling (Pressure Bar Screws)	AS32	200 (AS32-1)	\$26
 #14 x 1" FHP Self Drilling	AS35	100 (AS35-1)	\$20
 3 x 1/4 x 20 Hex Head Bolt SS	AS53	25 (AS53-1)	\$30
 1/4 Flat Washer SS	AS54	50 (AS54-1)	\$12
 1/4 x 20 Lock Nut SS	AS55	25 (AS55-1)	\$13
 Interior / Exterior Glazing Gasket at Glass	NG10	250 FT. (Per Roll)	\$155
 Exterior Perimeter Gasket	NG11	500 FT. (Per Roll)	\$313
 Butt Glaze Spacer Gasket	NG14	500 FT. (Per Roll)	\$245

ACCESSORIES			
PART DESCRIPTION	PART NO.	QTY	PRICE PER BOX
 Dry Glaze Gasket	NG16	500 FT.	\$668
 4" Long EPDM Setting Block for 1" Glass	SB18	100 (SB18-1)	\$80
 End Dam	SP204	50 (SP204-1)	\$24
 Butt Glaze Mullion Bridge for 1" Glazing	SP208	50 (SP208-1)	\$59
 Top and Bottom Mullion Cover	SP211	50 (SP211-1)	\$74
 Temporary Glazing Retainer	SP253	50 (SP253-1)	\$62
 Joint Sealant Tape (½" x 1/8" for Sealing Horizontal to Vertical Member Connections)	SM5601	30 FT. (Per Roll)	\$44
 1.475 x 1.475 x .180 Zinc Plated Steel Square Nut	AS13	50	\$62

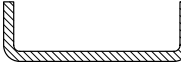
STEEL REINFORCING			
PART DESCRIPTION	PART NO.	QTY	PRICE
 <b>1⅞" x 4½" x ¼"</b> <b>with Zinc Chromate            Primer Steel Reinforcing</b>	SR150	1	\$461
		12'-0"	
 <b>1⅞" x 4½" x 10 Ga.</b> <b>Steel Reinforcing</b>	SR151	1	\$415
		14'-0"	
 <b>1⅞" x 4⅝" x ¼"</b> <b>with Zinc Chromate            Primer Steel Reinforcing</b>	SR504	1	\$409
		10'-0"	